



**Owner's Record**  
The model number is located at the rear and the serial number is located inside the battery compartment. Record the serial number in the space provided below. Refer to these numbers whenever you call upon your Sony dealer regarding this product.  
Model No. ICD-MX20 Serial No. \_\_\_\_\_

For the customers in the USA

**INFORMATION**  
This equipment has been tested and found to comply with the limits for a Class B digital device, pursuant to Part 15 of the FCC Rules. These limits are designed to provide reasonable protection against harmful interference in a residential installation. This equipment generates, uses, and can radiate radio frequency energy and, if not installed and used in accordance with the instructions, may cause harmful interference to radio communications.

However, there is no guarantee that interference will not occur in a particular installation. If this equipment does cause harmful interference to radio or television reception, which can be determined by turning the equipment off and on, the user is encouraged to try to correct the interference by one or more of the following measures:

- Reorient or relocate the receiving antenna.
- Increase the separation between the equipment and receiver.
- Connect the equipment into an outlet on a circuit different from that to which the receiver is connected.
- Consult the dealer or an experienced radio/TV technician for help.

You are cautioned that any changes or modifications not expressly approved in this manual could void your authority to operate this equipment.

**For "Memory Stick"**  
The following conditions (1) to (5) of the FCC Rules are applied to select the following two conditions (1) This device may not cause harmful interference, and (2) this device must accept any interference received, including interference that may cause undesired operation.

If you have any questions about this product, you may call Sony Customer Information Services Center 1-800-222-7669 or http://www.sony.com/

**Declaration of Conformity**  
Trade Name: SONY  
Model: ICD-MX20  
Responsible Party: Sony Electronics Inc.  
Address: 16250 Via Espirito, San Diego, CA 92127 U.S.A.  
Telephone Number: 858-942-2320

Operation is subject to the following two conditions: (1) This device may not cause harmful interference, and (2) this device must accept any interference received, including interference that may cause undesired operation.

The validity of the CE marking is restricted to only those countries where it is legally enforced, mainly in the countries EEA (European Economic Area).

Notice for users

©1999, 2000, 2001, 2002, 2003, 2004, 2005, 2006, 2007 Sony Corporation  
Documentation ©2007 Sony Corporation  
All rights reserved. This manual or the software described herein, in whole or in part, may not be reproduced, translated or copied in any machine readable form without prior written approval from Sony Corporation.

NO IN NO EVENT SHALL SONY CORPORATION BE LIABLE FOR ANY INCIDENTAL, CONSEQUENTIAL OR SPECIAL DAMAGES, WHETHER BASED ON TORT, CONTRACT, OR OTHERWISE, ARISING OUT OF OR IN CONNECTION WITH THIS MANUAL, THE SOFTWARE OR OTHER INFORMATION CONTAINED THEREIN OR THE USE THEREOF.

Sony Corporation reserves the right to make any modification to this manual or the information contained herein at any time without notice.

The software described herein may also be governed by the terms of the separate user license agreement.

- This software is for Windows and cannot be used for Macintosh.
- The supplied connecting cable is for the IC recorders ICD-MX20. You cannot connect other IC recorders.

**Information**  
IN NO EVENT SHALL SELLER BE LIABLE FOR ANY DIRECT, INCIDENTAL OR CONSEQUENTIAL DAMAGES OF ANY NATURE, OR LOSSES OR EXPENSES RESULTING FROM ANY DEFECTIVE PRODUCT OR THE USE OF ANY PRODUCT.

**Trademarks**  
"Memory Stick" and are trademarks of Sony Corporation.  
"MagicGate Memory Stick" is the trademark of Sony Corporation.  
"Memory Stick Duo" and **MEMORY STICK DUO** are trademarks of Sony Corporation.  
"Memory Stick PRO Duo" and **MEMORY STICK PRO DUO** are trademarks of Sony Corporation.  
"Microsoft, Windows, Outlook, Directx" are registered trademarks or trademarks of the Microsoft Corporation in the United States and/or other countries.  
"Intel Core" is a trademark or a registered trademark of Intel Corporation.  
"Intel Core" is a trademark or a registered trademark of Intel Corporation.  
"3 audio coding technology and patents licensed from Fraunhofer IIS and Thomson.

"iLPEC" and "LPE4" are registered trademarks of Sony Corporation.  
"USB" and "USB" are trademarks of Sony Corporation.  
"Apple and Macintosh" are trademarks of Apple Computer Inc., registered in the USA and other countries.  
"NaturallySpeaking, Dragon Systems" are trademarks owned by Nuance Communications, Inc. and are registered in the United States and/or other countries.

**gracemote**  
Music Identification Technology and associated data will be supplied through the Gracemote®. Gracemote MUSICID is the industry standard for digital music identification for both CDs and individual music files. For details, see the following web site: www.gracemote.com

Gracemote® is a registered trademark of the Gracemote, Inc. The Gracemote logo and logos that appear on the cover of Gracemote® logo are trademarks of the Gracemote, Inc. For use of the Gracemote services, see the following web page: www.gracemote.com/corporate

All other trademarks and registered trademarks are trademarks or registered trademarks of their respective holders. Furthermore, "™" and "®" are not mentioned in each case in this manual.

The "Digital Voice Editor" uses software modules as shown below:  
Microsoft® Direct®  
©2001 Microsoft Corporation. All rights reserved.

**Troubleshooting**  
Before taking the unit for repair, check the following sections. Should any problem persist after you have made these checks, consult your nearest Sony dealer.

IC Recorder

**The unit does not operate.**

- The batteries have been inserted with incorrect polarity.
- The batteries are weak.
- The buttons are locked with the HOLD switch. (If you press any button, "HOLD" will appear for 3 seconds.)

**The "Memory Stick" is not recognized.**  
The number of folders automatically created in the "Memory Stick" is less than 5.

**"Memory Stick" contains image data or other files.**  
The memory required for creating initial folders is insufficient. Use the Windows Explorer or other tool to delete unnecessary files or use "Format" menu of the built-in "Memory Stick".

**No sound comes from the speaker.**

- The headphones are plugged in.
- The volume is turned down completely.

**Sound comes from the speaker even when the headphones are plugged in.**

- If you plug in the headphones not securely during playback, the sound may come from the speaker. Unplug the headphones and then insert them securely.

**The OPR indicator does not light.**

- The "LED" in the menu is set to "OFF". Display the menu and set the "LED" to "ON".

**You cannot start recording.**

- The memory is full. Erase some of the messages. Or use the Digital Voice Editor to save the IC recorder messages to the hard disk of your PC. You can also use the "Memory Stick" with sufficient capacity.
- The write-protect switch on the inserted "Memory Stick" is set to "LOCK".
- 999 messages have already been recorded in the selected folder. Select another folder or erase some of the messages.

**The software "hands" when the Digital Voice Editor software starts up.**

- Do not disconnect the connector of the IC recorder while the computer is communicating with the IC recorder. Otherwise the computer operations become unstable or the data inside the IC recorder may be damaged.
- There may be conflict between the software and other driver or application.
- Do not install the "Memory Stick Voice Editor" software and the Digital Voice Editor Ver. 2s software after you installed the Digital Voice Editor software. The Digital Voice Editor software may not operate properly.

Please note that recorded messages may be erased during service or repair work.

Getting started  
Step 1: Installing the Batteries

1 Slide and open the battery compartment lid.

2 Insert two LR03 (size AAA) alkaline batteries with correct polarity, and close the lid. Make sure to insert batteries into the unit in the end-first.

When you insert batteries for the first time, or when you insert batteries after the unit has been without batteries for a certain period of time, "Set Date&Time" appears. Please refer "Step 2, Setting the Clock" to set the date and time.

If the battery compartment lid is accidentally detached, attach it as illustrated.

**Replacing the batteries**  
The battery indicator on the display window shows the battery condition:  
: Replace both of the two batteries with new ones.  
: "Replace Batteries" appears and the unit will stop operation.

**Battery life\*** (Using Sony alkaline batteries LR03 (SG))  
Recording mode: ST STLP SP LP  
In recording: 8 hr. 9 hr. 30 min. 9 hr. 30 min. 10 hr. 30 min.  
In playback: 8 hr. 9 hr. 9 hr. 9 hr. (hr.: hours/min.:minutes)

\* In continuous recording/playback  
\* In approximate hours and minutes  
\* When playing back through the internal speaker with the medium volume level  
\* The battery life may shorten depending on the operation of the unit.

**Using on house current**  
Connect the AC power adaptor (not supplied) to the DC IN 3V jack of the unit and to the wall outlet. Do not use any other AC-power adaptor.

**To DC IN 3V jack**  
AC power adaptor (not supplied)

**Polarity of the plug**

Step 2: Setting the Clock

You need to set the clock to use the alarm function or record the date and time. When you insert batteries for the first time, or when you insert batteries after the unit has been without batteries for a certain period of time, "Set Date&Time" appears. Set the date and time as follows:

**Noise is heard.**

- An object, such as your finger, etc., accidentally rubbed or scratched the unit during recording so that noise was recorded.
- The unit was placed near an AC power source, a fluorescent lamp or a mobile phone during recording or playback.
- Plug-in of the connected microphone was dirty when recording. Clean the plug.
- Headphones plug is dirty. Clean the plug.

**Recording level is low.**

- "Mic Sense" (microphone sensitivity) is set to "Low".
- If it is difficult to hear a small sound of a recorded message, slide the VOICE UP switch to "ON". Playback sound may become more audible.

**Playback speed is too fast or too slow.**

- The playback speed is set to "ST" in the menu. Slide the DPC switch to "OFF" or display the "DPC" in the menu and adjust the playback speed.

**"-Y-M-D" or "-:-" is displayed.**

- You have not set the clock. Display the "Date&Time" in the menu and set the clock.

**"-Y-M-D" or "-:-" is displayed as the recorded date.**

- The date and time of recording will not be displayed if you recorded the message when the clock was not set. Display the "Date&Time" in the menu and set the clock.

**There are fewer menu items in the menu mode.**

- There are some menu items that do not displayed while the set is in recording or playback mode.

**A character in a folder or message name is displayed as "□".**

- The unit cannot support and display some characters which are entered using the supplied "Digital Voice Editor" software.
- Messages are not sorted in order of the number of priority marks in a folder.
- Unless you sort messages using the supplied "Digital Voice Editor" software, messages are displayed in the order of the number of priority marks in the computer using the supplied "Digital Voice Editor" software.

**The remaining time displayed in the display window is shorter than that displayed in the supplied "Digital Voice Editor" software.**

- The unit requires a certain amount of memory for system operation. That amount is subtracted from the remaining time, which is the reason for the difference.

**The battery life is short.**

- The battery life mentioned in "Step 1: Installing the Batteries" is based on playback through internal speaker with the medium volume level (monaural sound) using LRI03(SG). The battery life may shorten depending on the operation of the unit.

**"ACCESS" display does not disappear.**

- If the unit is required to process excessive amount of data, "ACCESS" may be displayed for an extended period of time. This is not a malfunction of the unit. Wait until the message disappears.

**The unit does not operate correctly.**

- Take out the batteries and insert them again with correct polarity.

**You cannot connect the unit to the PC.**

- Refer to the help files of the Digital Voice Editor 3 software.

**Digital Voice Editor**  
Refer to the Help files of the Digital Voice Editor software, too.

**The Digital Voice Editor software cannot be installed.**

- The free disk or memory space on the computer is too small. Check the hard disk and memory space.
- Make sure to install the software in the operating system that the Digital Voice Editor software does not support.
- In Windows® XP Media Center Edition 2005/Windows® XP Media Center Edition 2006/Windows® XP Media Center Edition/Windows® XP Professional/Windows® XP Home Edition, you log on as a user name belonging to a user account with limitations. Make sure to log on as a user name with the "Computer administrator" user account. In Windows® 2000 Professional, make sure to log on as the user name of "Administrator".

**The IC recorder or "Memory Stick" cannot be properly connected.**

- Check that the installation of the software has been successful. Also check the connection as follows:
  - When using an external USB hub, connect the IC recorder directly to the computer.
  - Disconnect and then connect the cable with the IC recorder. - Connect the IC recorder to another USB connector.
  - Your computer may be in the system standby/hibernate mode. When connecting to the IC recorder, the hibernate mode while being connected to the IC recorder.

**The IC recorder does not operate.**

- You may format the memory of the IC recorder. Use the IC recorder formatting function to format the memory.

**Messages cannot be played back/Playback sound volume is too low.**

- No sound board is installed.
- No speaker is built-in or connected to the computer.
- The volume of the sound is turned down.
- Turn up the volume on the computer. (Refer to the instruction manual of the computer.)
- The volume of WAV files can be changed and saved using the "Increase Volume" feature of the Microsoft Sound Recorder.

**Saved message files cannot be played back or edited.**

- You cannot play back a message whose file format the Digital Voice Editor software does not support. Depending on the file format, you cannot use part of editorial features of the software.

**Releasing pause and resume recording**  
listen to the current recording  
review the current recording  
review during recording

**The software "hands" when the Digital Voice Editor software starts up.**

- Do not disconnect the connector of the IC recorder while the computer is communicating with the IC recorder.
- There may be conflict between the software and other driver or application.
- Do not install the "Memory Stick Voice Editor" software and the Digital Voice Editor Ver. 2s software after you installed the Digital Voice Editor software. The Digital Voice Editor software may not operate properly.

Please note that recorded messages may be erased during service or repair work.

\* About one hour after you pause recording, recording pause is automatically released and the unit goes into the stop mode.

Playing Back Messages

When playing back a previously recorded message, start from Step 1. When playing back a message you have just finished recording, start from Step ②.

1 Select the folder.  
Follow the step 2 in "Recording Messages".

2 Select the message and start playback.

Ⓛ (headphones) jack

① Press **▲** or **▼** to display the desired message number.  
**▲**: for previous message number  
**▼**: for next message number  
② Press **■**.  
Selected message number/Number of messages in the selected folder

**Playback slider**  
Displays the current playback position.  
**Counter display\***  
Recorded date and time of the message

**OPR indicator\*\*** (lights in green during playback)  
③ Adjust the volume with **VOLUME +/-**.

\* The display selected with the "Display" in the menu appears.  
\*\*When the "LED" in the menu is set to "OFF", the OPR indicator turns off.

④ When playback is done to the end of the last message.  
• When fast playback is done to the end of the last message, "Message End" flashes for 3 seconds. (You cannot hear the playback sound.)  
• If you keep **▲** pressed, the unit starts to search at higher speed. During cue/review, the counter will be displayed, regardless of the display mode setting.

⑤ When playback or fast playback is done to the end of the last message.  
• When "Message End" stops flashing and the OPR indicator goes off, the unit will stop at the beginning of the last message.  
• If the last message is long and you wish to start playback at a later part of the message, keep **▼** pressed to play back the message to the end and then press **▲** while "Message End" is flashing to go back to the desired point.

⑥ For messages other than the last one, go to the beginning of the next message and play backward to the desired point.

**Listening in better sound quality**  
You can enjoy better sound quality as follows:  
• To listen from headphones: Connect the stereo headphones (supplied or not supplied) to the (headphones) jack. The built-in speaker will be automatically disconnected.  
• To listen from an external speaker: Connect an active or passive speaker (not supplied) to the (headphones) jack.

**Stop at the current position**  
Do this  
**▶**: **■** STOP.  
To resume playback from that point, press **▶** again.

**go back to the beginning of the current message**  
**◀**: **■** once.  
**skip to the next message**  
**▶**: **■** once.  
**go back to previous messages/skip to succeeding messages**  
**◀** or **▶** repeatedly. (During stop mode, keep the key pressed to skip the messages continuously.)

\* These operations are for when "Easy Search" in the menu is set to "OFF".

Operating the Menu

During stop, playback or recording, you can use the menu to change the operation modes in playback and recording, display mode, or other settings. Display the menu and change the settings as follows:

To	Do this
Enter the menu mode	Press <b>⏏</b> (MENU).
Select the desired menu item	Press <b>▲/▼</b> and press <b>■</b> .
Select the desired menu item	Press <b>▲/▼</b> and press <b>■</b> .
go back to the previous step.	Press <b>◀</b> or <b>▶</b> to return to the previous step.
Select the setting item.	Press <b>▲/▼</b> and press <b>■</b> .
Exit the menu mode.	Press <b>▶</b> (STOP).

These operations are for when "Easy Search" in the menu is set to "OFF".

Tip  
This unit does not have a power on/off switch. The display is shown at all times.

**2 Press **▲/▼** to select the digits for the year.**  
**▲**: to decrease the number  
**▼**: to increase the number

**2 Press **■**.**  
The month digits will flash.

**3 Repeat steps 1 and 2 to set the month, day, hour, and then minutes in sequence.**  
To select a previous or next item  
Press **◀** for the previous item or **▶** for the next item

**4 Press **■** STOP to return to the normal display.**

**1 Press **▲/▼** to select the digit for the year.**  
**▲**: to decrease the number  
**▼**: to increase the number

**2 Press **■**.**  
The month digits will flash.

**3 Repeat steps 1 and 2 to set the month, day, hour, and then minutes in sequence.**  
To select a previous or next item  
Press **◀** for the previous item or **▶** for the next item

**4 Press **■** STOP to return to the normal display.**

**1 Press **▲/▼** to select the digit for the year.**  
**▲**: to decrease the number  
**▼**: to increase the number

**2 Press **■**.**  
The month digits will flash.

**3 Repeat steps 1 and 2 to set the month, day, hour, and then minutes in sequence.**  
To select a previous or next item  
Press **◀** for the previous item or **▶** for the next item

**4 Press **■** STOP to return to the normal display.**

**1 Press **▲/▼** to select the digit for the year.**  
**▲**: to decrease the number  
**▼**: to increase the number

**2 Press **■**.**  
The month digits will flash.

**3 Repeat steps 1 and 2 to set the month, day, hour, and then minutes in sequence.**  
To select a previous or next item  
Press **◀** for the previous item or **▶** for the next item

**4 Press **■** STOP to return to the normal display.**

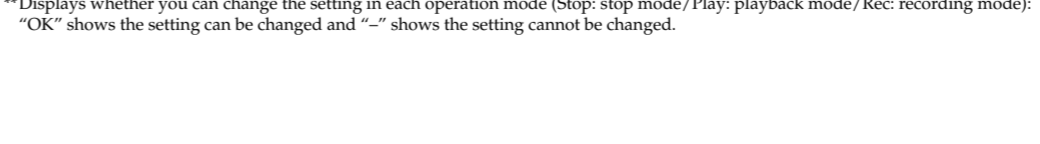
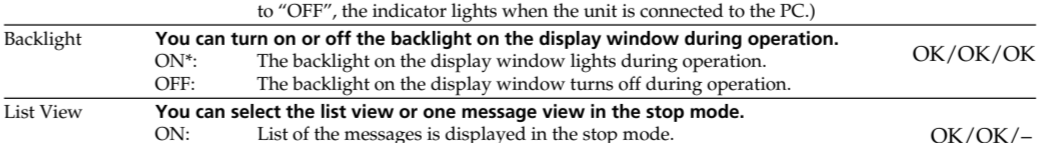
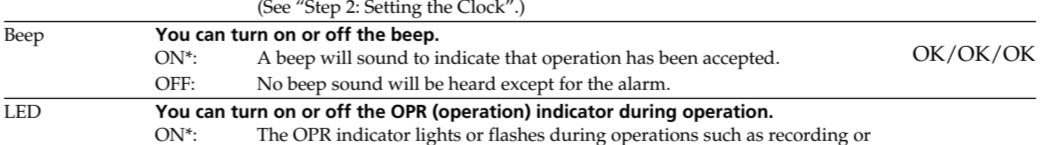
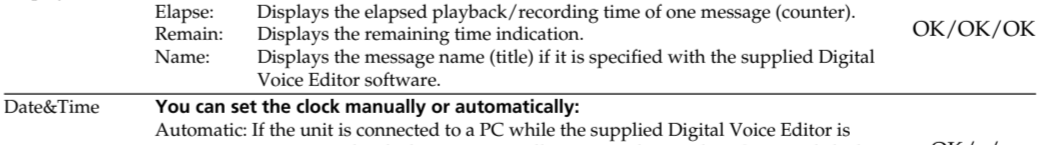
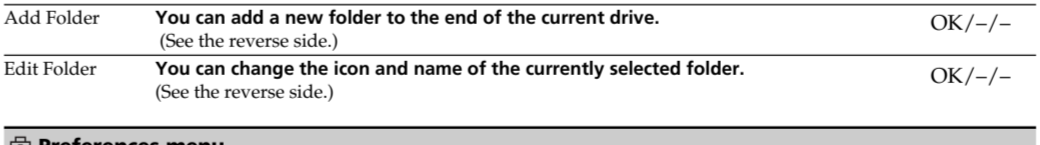
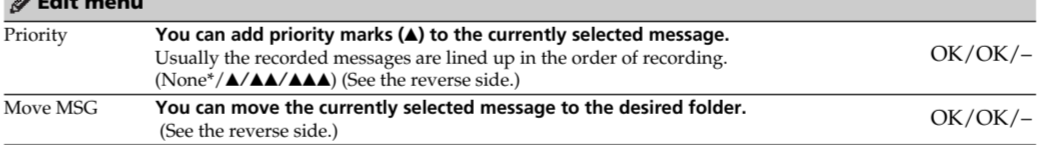
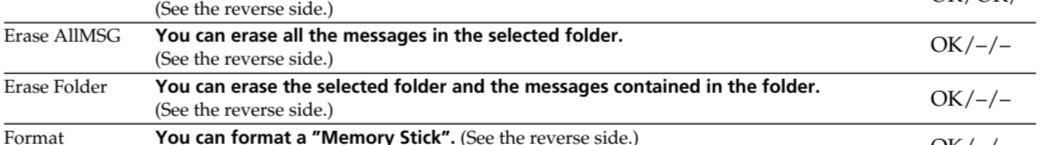
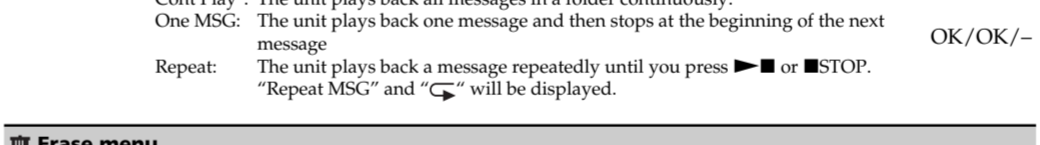
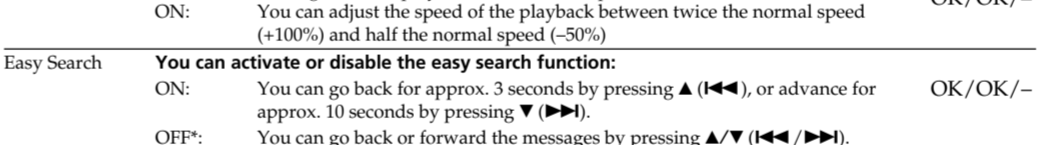
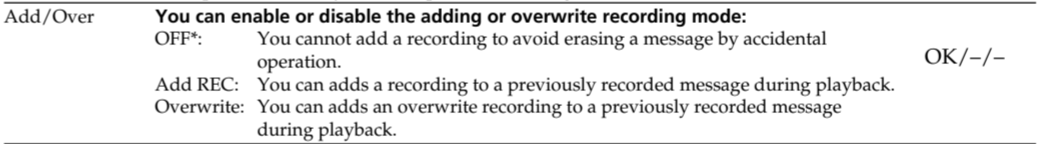
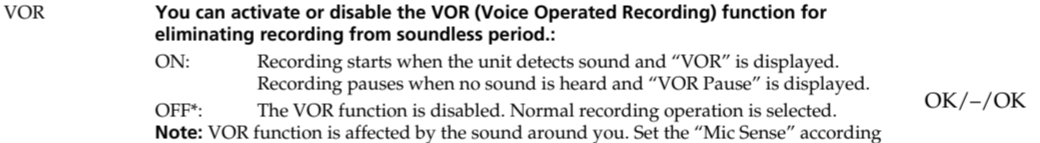
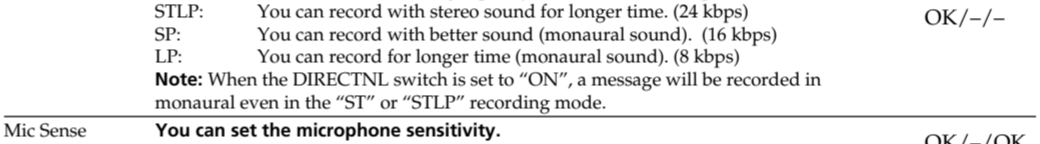
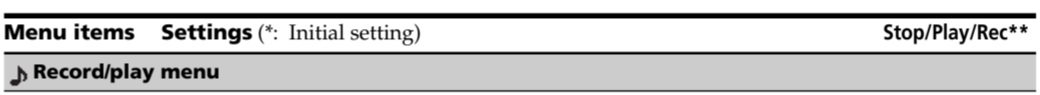
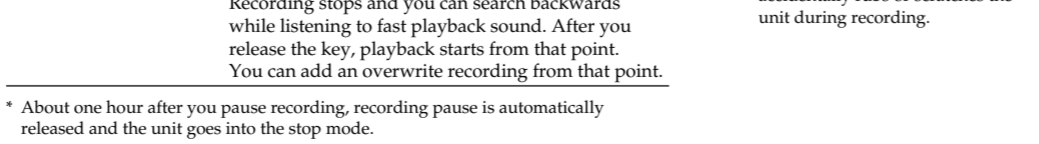
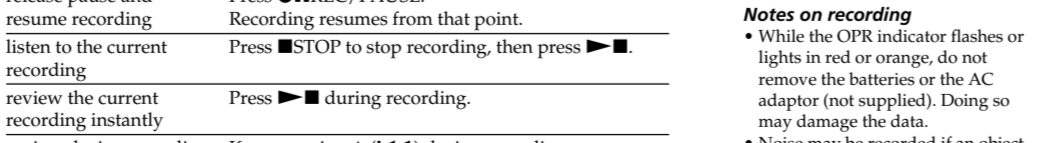
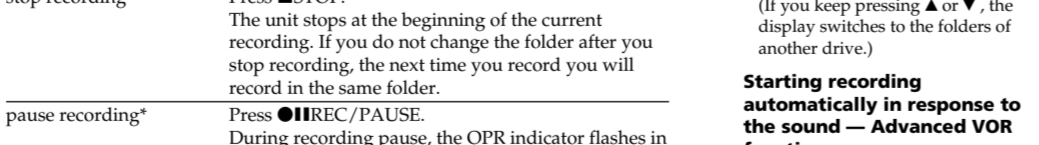
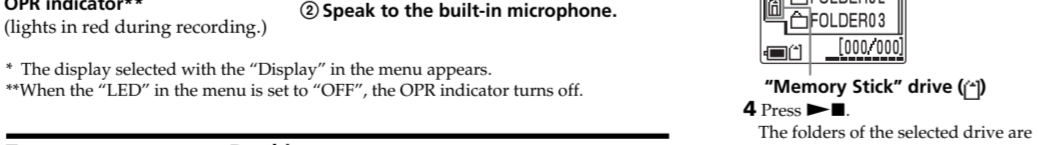
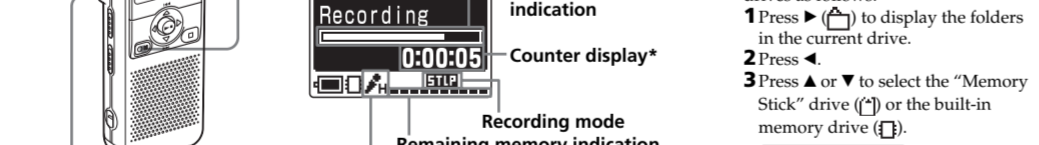
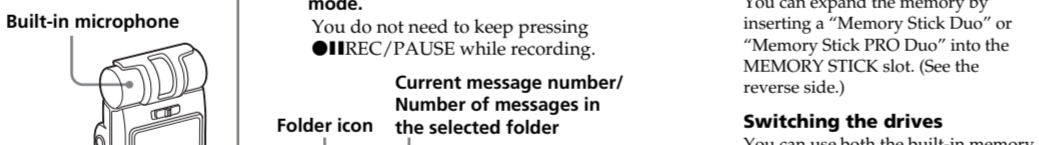
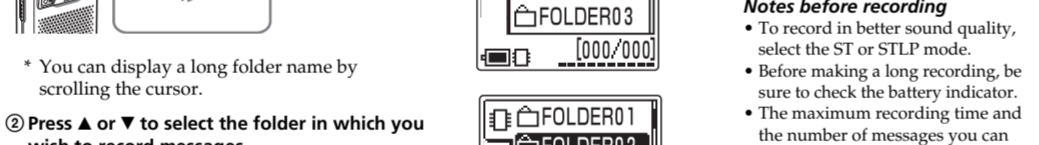
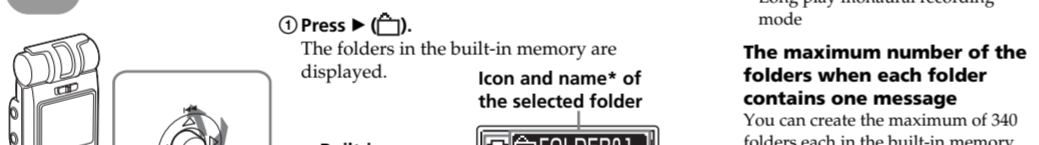
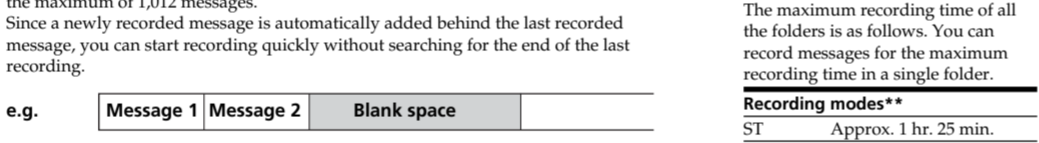
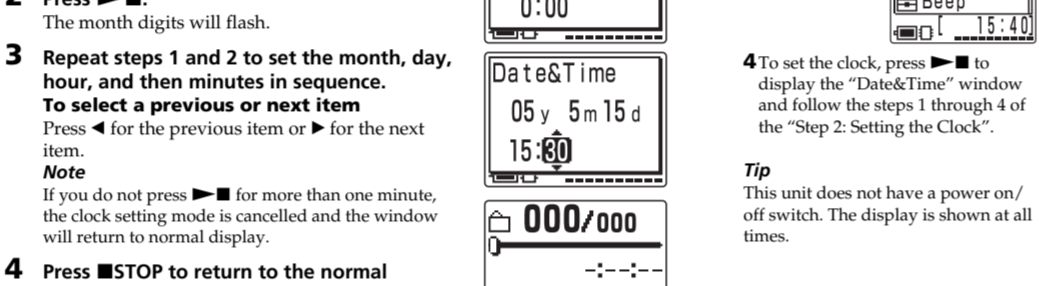
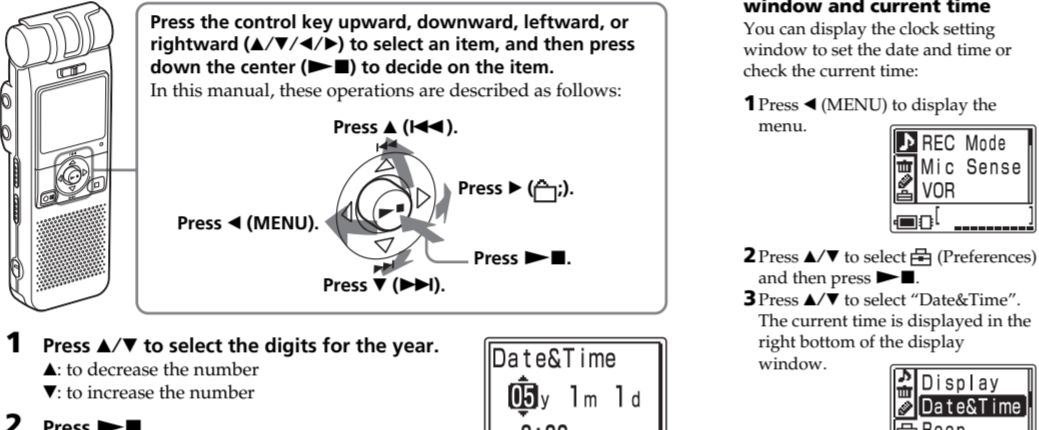

Index to Parts and Controls

Identifying the front and rear panels of the unit

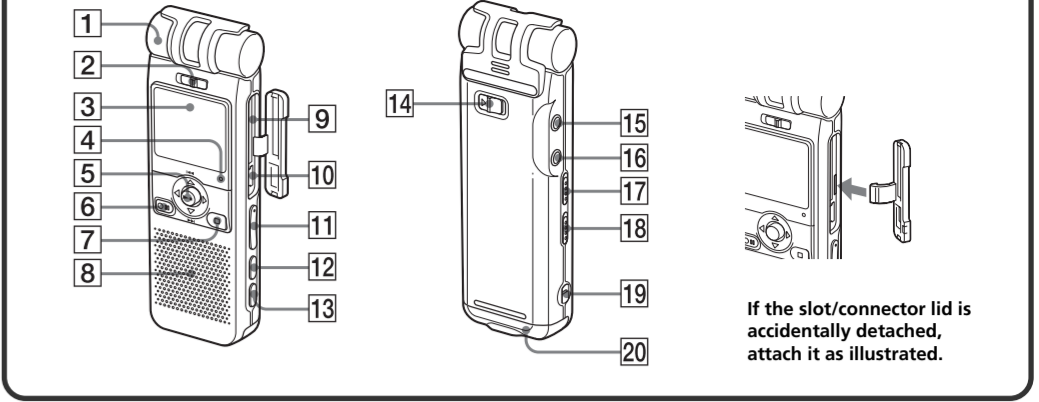

14 **HOLD switch**  
To prevent accidental operation, slide this switch to "ON". "HOLD" will appear for 3 seconds, indicating that all the functions of the buttons are locked. When the HOLD function is activated during stop, all the display will be turned off after "HOLD" is displayed.

2 **DIRECT (directional) ON (MONO)/OFF switch**  
Slide the switch to set the directionality of the built-in microphone [1] as follows:  
ON (MONO): To record a sound centering on a specific direction in monaural. Use this position when you record a sound at a conference/meeting or in a spacious place etc.  
OFF: To record a sound not centering on a specific direction (all-directional recording).

Notes  
• The DIRECT switch is set to "ON", sound is recorded in monaural even if you set ST or STLP mode.  
• In the ST and STLP mode, sound is recorded in higher quality sound thanks to their higher bit rates even in the monaural recording.

3 **Display window**  
For the details, see "Using the display window" below.

4 **OPR (operation) indicator**  
The indicator lights in red during recording or in green during playback. It flashes in red during recording pause. During accessing the data, it lights or flashes in red or orange. You can turn off the indicator with the "LED" in the menu.

5 **Counter key**  
◀(MENU)/▶(folder)/◀(review)/▶(fast forward)/▶(play/stop+enter)

6 **●/■ (record)/PAUSE button**  
Press here to start and pause recording.

7 **▶ (stop) button**  
Press here to stop operation.

8 **Speaker**  
Sound is heard when no headphones or active speaker are connected.

9 **MEMORY STICK slot**  
Insert the "Memory Stick Duo" or "Memory Stick PRO Duo" here.

10 **USB connector**  
Use the USB cable to connect a PC here.

11 **VOLUME (volume) +/- button**  
Adjust the playback sound with the button.

12 **DIVIDE button**  
Press to divide a message during playback.

13 **A-B repeat button**  
Press to specify the beginning and ending points of the portion to be played back repeatedly.

14 **Handstrap**  
You can attach a handstrap (not supplied) here.

15 **Battery compartment/DC IN 3V jack**  
Open the compartment lid and insert two LR03 (size AAA) alkaline batteries.

16 **Microwind**  
The effect of the back light of the display window may be reduced in a bright location.

17 **Switching the one message view and the list view**  
You can choose how the messages will be displayed on the stop mode between list view and one message view as follows:

1 **Press **◀** (MENU).**  
The menu window is displayed.

2 **Press **▲/▼** to select **Ⓛ** (Preferences) and then **press **■**.**  
The Preferences menu is displayed.**

3 **Press **▲/▼** to select "List View".**

4 **Press **■**.**  
The "List View" setting window is displayed.

5 **Press **▲/▼** to select "OFF" (list view) and then **press **■**.**  
The setting will be changed.**

6 **Press **▶** (STOP) to return to the normal display.**

18 **Microphone sensitivity indication**



## ► Various Ways of Recording

### Adding a Recording to a Previously Recorded Message

You can add a recording to the message being played back.

- Note**
- At a factory setting, you cannot add a recording not to erase the message by accidental operation. To add or overwrite a recording, set the "Add/Over" in the menu to "Add REC" or "Overwrite".
  - The added or overwritten portion of a message will be recorded in the same recording mode (ST, STLP, SP or LP) as the original message, regardless of the current recording mode setting.
  - You cannot add or overwrite a recording if the remaining memory is not long enough. For more information, see "Troubleshooting".

**When "Add REC" is selected in the menu**  
The added recording will be placed after the current message and counted as a part of the message.

**During playback of Message 3**

**After adding a recording**

**When "Overwrite" is selected in the menu**  
You can add an overwrite recording after the selected point in a recorded message. The part of the message after the selected point is deleted.

**The starting point of an overwrite recording**

**When "Overwrite" is selected in the menu**

**Added overwrite recording in Message 3**

- During playback, press **■** (REC/PAUSE) briefly.**  
The "Add REC" or "Overwrite" will appear and the unit stops by recording stand-by mode.

- While the "Add REC" or "Overwrite" appears, press **■** (REC/PAUSE) again.**  
The "Add REC" or "Overwrite" will appear and the unit stops by recording stand-by mode.

- Press **■** (STOP) to stop the recording.**

### Recording with an External Microphone or Other Equipment

#### Recording with an external microphone

Connect an external microphone to the  $\phi$  (microphone) jack.  
When you connect an external microphone, the built-in microphone is automatically cut off. When a plug in power type microphone is connected, power is automatically supplied to the microphone from the IC recorder.

**External Stereo Microphone (not supplied)**

**Recommended types of microphones**  
You can use the ECM-CS10 Sony electret condenser microphone (not supplied).

#### Recording from other equipment

To record sound of other equipment with the IC recorder, connect the  $\phi$  (microphone) jack of the IC recorder to the earphone jack of other equipment (tape recorder, etc.) by using a resistance audio connecting cable.  
Before you start recording, set the microphone sensitivity by setting the "Mic Sense" in the menu to "High".

**Note**

- If you use an audio connecting cable without a resistor, sound may be recorded interrupted. Make sure to use a resistance audio connecting cable.

#### Recording with other equipment

To record the sound of the IC recorder with other equipment, connect the  $\phi$  (headphones) jack of the IC recorder to the audio or line input connector (stereo mini-plug) of other equipment.  
To the audio or line input connector (stereo mini-plug) of other equipment.

**Note**

- Make sure that the plugs are connected securely.
- We recommend you make a trial recording to check the connections and volume control.
- When connecting equipment other than Sony's, refer to the instruction manual of the equipment.

## ► Various Ways of Playback

### Locating quickly the point you wish to start playback (Easy Search)

You can quickly locate the point you wish to start playback by pressing **■** (←) (◀) (▶) (→) repeatedly during playback. This function is useful when locating a desired point in a long recording.  
Set "Easy Search" in the menu as follows:  
ON: You can go back for approx. 3 seconds by pressing **■** (←) (▶), or advance for approx. 10 seconds by pressing **■** (◀) (▶).  
OFF: You can go back or forward the messages by pressing **■** (←) (▶).

### ► Editing Messages

#### Erasing Messages

**Note**  
Once a recording has been erased, you cannot retrieve it.

#### Erasing messages one by one

You can erase unnecessary messages one by one. When a message is erased, the remaining messages will advance and be renumbered so that there will be no space between messages.

**Before erasing Erase Message 3**

**After erasing**

**Repeating a message**

Set "Play Mode" in the menu to "Repeat" and press **■** (▶) (▶) repeatedly during playback. This function is useful when locating a desired point in a long recording.

Set "Easy Search" in the menu as follows:  
ON: You can go back for approx. 3 seconds by pressing **■** (←) (▶), or advance for approx. 10 seconds by pressing **■** (◀) (▶).  
OFF: You can go back or forward the messages by pressing **■** (←) (▶).

#### Playing back a message repeatedly — Repeat Play

#### Repeating a message

Set "Play Mode" in the menu to "Repeat" and press **■** (▶) (▶) repeatedly during playback. This function is useful when locating a desired point in a long recording.

#### To resume normal playback

Press **■** (STOP) in the menu to "One MSG" or "Cont Play".

#### Playing back the specified section repeatedly — A-B Repeat

While playing back a message, you can set the start (A) and end (B) points for a section you wish to play repeatedly.

**During playback, press A-B (▶) (▶) (▶) repeatedly.**  
The starting point (A) of the section you wish to play repeatedly is set. "A-B Repeat" appears.

**During playback, press A-B (▶) (▶) (▶) repeatedly again.**  
The finishing point (B) of the section is set. "A-B Repeat" is displayed and the specified section is played back repeatedly.

#### To resume normal playback

Press **■** (STOP).

#### To stop A-B Repeat playback

Press **■** (STOP).

#### Notes

- You cannot set A-B Repeat for a section that overlaps two or more messages.
- If you do not set the finishing point (B), the finishing point is automatically set at the end (or the beginning) of the message.

### ► Playing Back a Message at a Desired Time with an Alarm

You can sound an alarm and start playback of a selected message at a desired time. You can have the message played back at a specified date, once every week, or the same time everyday.

You can also sound the alarm without playing back a message.

**Note**  
When the clock is not set or no messages are recorded, you cannot set the alarm.

#### 1 Display the message you want to set the alarm.

Press **■** (MENU), and select **■** (Edit) by pressing **■** (▲/▼), and then press **■** (▶).

Press **■** (MENU), and select **■** (Edit) by pressing **■** (▲/▼), and then press **■** (▶).

Press **■** (MENU), and select **■** (Edit) by pressing **■** (▲/▼), and then press **■** (▶).

Press **■** (MENU), and select **■** (Edit) by pressing **■** (▲/▼), and then press **■** (▶).

Press **■** (MENU), and select **■** (Edit) by pressing **■** (▲/▼), and then press **■** (▶).

Press **■** (MENU), and select **■** (Edit) by pressing **■** (▲/▼), and then press **■** (▶).

Press **■** (MENU), and select **■** (Edit) by pressing **■** (▲/▼), and then press **■** (▶).

Press **■** (MENU), and select **■** (Edit) by pressing **■** (▲/▼), and then press **■** (▶).

Press **■** (MENU), and select **■** (Edit) by pressing **■** (▲/▼), and then press **■** (▶).

Press **■** (MENU), and select **■** (Edit) by pressing **■** (▲/▼), and then press **■** (▶).

Press **■** (MENU), and select **■** (Edit) by pressing **■** (▲/▼), and then press **■** (▶).

Press **■** (MENU), and select **■** (Edit) by pressing **■** (▲/▼), and then press **■** (▶).

Press **■** (MENU), and select **■** (Edit) by pressing **■** (▲/▼), and then press **■** (▶).

Press **■** (MENU), and select **■** (Edit) by pressing **■** (▲/▼), and then press **■** (▶).

Press **■** (MENU), and select **■** (Edit) by pressing **■** (▲/▼), and then press **■** (▶).

Press **■** (MENU), and select **■** (Edit) by pressing **■** (▲/▼), and then press **■** (▶).

Press **■** (MENU), and select **■** (Edit) by pressing **■** (▲/▼), and then press **■** (▶).

Press **■** (MENU), and select **■** (Edit) by pressing **■** (▲/▼), and then press **■** (▶).

Press **■** (MENU), and select **■** (Edit) by pressing **■** (▲/▼), and then press **■** (▶).

Press **■** (MENU), and select **■** (Edit) by pressing **■** (▲/▼), and then press **■** (▶).

Press **■** (MENU), and select **■** (Edit) by pressing **■** (▲/▼), and then press **■** (▶).

Press **■** (MENU), and select **■** (Edit) by pressing **■** (▲/▼), and then press **■** (▶).

Press **■** (MENU), and select **■** (Edit) by pressing **■** (▲/▼), and then press **■** (▶).

Press **■** (MENU), and select **■** (Edit) by pressing **■** (▲/▼), and then press **■** (▶).

Press **■** (MENU), and select **■** (Edit) by pressing **■** (▲/▼), and then press **■** (▶).

Press **■** (MENU), and select **■** (Edit) by pressing **■** (▲/▼), and then press **■** (▶).

Press **■** (MENU), and select **■** (Edit) by pressing **■** (▲/▼), and then press **■** (▶).

Press **■** (MENU), and select **■** (Edit) by pressing **■** (▲/▼), and then press **■** (▶).

Press **■** (MENU), and select **■** (Edit) by pressing **■** (▲/▼), and then press **■** (▶).

Press **■** (MENU), and select **■** (Edit) by pressing **■** (▲/▼), and then press **■** (▶).

Press **■** (MENU), and select **■** (Edit) by pressing **■** (▲/▼), and then press **■** (▶).

Press **■** (MENU), and select **■** (Edit) by pressing **■** (▲/▼), and then press **■** (▶).

Press **■** (MENU), and select **■** (Edit) by pressing **■** (▲/▼), and then press **■** (▶).

Press **■** (MENU), and select **■** (Edit) by pressing **■** (▲/▼), and then press **■** (▶).

Press **■** (MENU), and select **■** (Edit) by pressing **■** (▲/▼), and then press **■** (▶).

Press **■** (MENU), and select **■** (Edit) by pressing **■** (▲/▼), and then press **■** (▶).

Press **■** (MENU), and select **■** (Edit) by pressing **■** (▲/▼), and then press **■** (▶).

Press **■** (MENU), and select **■** (Edit) by pressing **■** (▲/▼), and then press **■** (▶).

Press **■** (MENU), and select **■** (Edit) by pressing **■** (▲/▼), and then press **■** (▶).

Press **■** (MENU), and select **■** (Edit) by pressing **■** (▲/▼), and then press **■** (▶).

Press **■** (MENU), and select **■** (Edit) by pressing **■** (▲/▼), and then press **■** (▶).

Press **■** (MENU), and select **■** (Edit) by pressing **■** (▲/▼), and then press **■** (▶).

Press **■** (MENU), and select **■** (Edit) by pressing **■** (▲/▼), and then press **■** (▶).

Press **■** (MENU), and select **■** (Edit) by pressing **■** (▲/▼), and then press **■** (▶).

Press **■** (MENU), and select **■** (Edit) by pressing **■** (▲/▼), and then press **■** (▶).

Press **■** (MENU), and select **■** (Edit) by pressing **■** (▲/▼), and then press **■** (▶).

Press **■** (MENU), and select **■** (Edit) by pressing **■** (▲/▼), and then press **■** (▶).

Press **■** (MENU), and select **■** (Edit) by pressing **■** (▲/▼), and then press **■** (▶).

Press **■** (MENU), and select **■** (Edit) by pressing **■** (▲/▼), and then press **■** (▶).

Press **■** (MENU), and select **■** (Edit) by pressing **■** (▲/▼), and then press **■** (▶).

Press **■** (MENU), and select **■** (Edit) by pressing **■** (▲/▼), and then press **■** (▶).

Press **■** (MENU), and select **■** (Edit) by pressing **■** (▲/▼), and then press **■** (▶).

Press **■** (MENU), and select **■** (Edit) by pressing **■** (▲/▼), and then press **■** (▶).

Press **■** (MENU), and select **■** (Edit) by pressing **■** (▲/▼), and then press **■** (▶).

Press **■** (MENU), and select **■** (Edit) by pressing **■** (▲/▼), and then press **■** (▶).

Press **■** (MENU), and select **■** (Edit) by pressing **■** (▲/▼), and then press **■** (▶).

Press **■** (MENU), and select **■** (Edit) by pressing **■** (▲/▼), and then press **■** (▶).

Press **■** (MENU), and select **■** (Edit) by pressing **■** (▲/▼), and then press **■** (▶).

Press **■** (MENU), and select **■** (Edit) by pressing **■** (▲/▼), and then press **■** (▶).

Press **■** (MENU), and select **■** (Edit) by pressing **■** (▲/▼), and then press **■** (▶).

Press **■** (MENU), and select **■** (Edit) by pressing **■** (▲/▼), and then press **■** (▶).

Press **■** (MENU), and select **■** (Edit) by pressing **■** (▲/▼), and then press **■** (▶).

Press **■** (MENU), and select **■** (Edit) by pressing **■** (▲/▼), and then press **■** (▶).

Press **■** (MENU), and select **■** (Edit) by pressing **■** (▲/▼), and then press **■** (▶).

Press **■** (MENU), and select **■** (Edit) by pressing **■** (▲/▼), and then press **■** (▶).

Press **■** (MENU), and select **■** (Edit) by pressing **■** (▲/▼), and then press **■** (▶).

Press **■** (MENU), and select **■** (Edit) by pressing **■** (▲/▼), and then press **■** (▶).

Press **■** (MENU), and select **■** (Edit) by pressing **■** (▲/▼), and then press **■** (▶).

Press **■** (MENU), and select **■** (Edit) by pressing **■** (▲/▼), and then press **■** (▶).

Press **■** (MENU), and select **■** (Edit) by pressing **■** (▲/▼), and then press **■** (▶).

Press **■** (MENU), and select **■** (Edit) by pressing **■** (▲/▼), and then press **■** (▶).

Press **■** (MENU), and select **■** (Edit) by pressing **■** (▲/▼), and then press **■** (▶).

Press **■** (MENU), and select **■** (Edit) by pressing **■** (▲/▼), and then press **■** (▶).

Press **■** (MENU), and select **■** (Edit) by pressing **■** (▲/▼), and then press **■** (▶).

Press **■** (MENU), and select **■** (Edit) by pressing **■** (▲/▼), and then press **■** (▶).

Press **■** (MENU), and select **■** (Edit) by pressing **■** (▲/▼), and then press **■** (▶).

Press **■** (MENU), and select **■** (Edit) by pressing **■** (▲/▼), and then press **■** (▶).

Press **■** (MENU), and select **■** (Edit) by pressing **■** (▲/▼), and then press **■** (▶).

Press **■** (MENU), and select **■** (Edit) by pressing **■** (▲/▼), and then press **■** (▶).

Press **■** (MENU), and select **■** (Edit) by pressing **■** (▲/▼), and then press **■** (▶).

Press **■** (MENU), and select **■** (Edit) by pressing **■** (▲/▼), and then press **■** (▶).

Press **■** (MENU), and select **■** (Edit) by pressing **■** (▲/▼), and then press **■** (▶).

Press **■** (MENU), and select **■** (Edit) by pressing **■** (▲/▼), and then press **■** (▶).

Press **■** (MENU), and select **■** (Edit) by pressing **■** (▲/▼), and then press **■** (▶).

Press **■** (MENU), and select **■** (Edit) by pressing **■** (▲/▼), and then press **■** (▶).

Press **■** (MENU), and select **■** (Edit) by pressing **■** (▲/▼), and then press **■** (▶).

Press **■** (MENU), and select **■** (Edit) by pressing **■** (▲/▼), and then press **■** (▶).

Press **■** (MENU), and select **■** (Edit) by pressing **■** (▲/▼), and then press **■** (▶).

Press **■** (MENU), and select **■** (Edit) by pressing **■** (▲/▼), and then press **■** (▶).

Press **■** (MENU), and select **■** (Edit) by pressing **■** (▲/▼), and then press **■** (▶).

Press **■** (MENU), and select **■** (Edit) by pressing **■** (▲/▼), and then press **■** (▶).

Press **■** (MENU), and select **■** (Edit) by pressing **■** (▲/▼), and then press **■** (▶).

Press **■** (MENU), and select **■** (Edit) by pressing **■** (▲/▼), and then press **■** (▶).

Press **■** (MENU), and select **■** (Edit) by pressing **■** (▲/▼), and then press **■** (▶).

Press **■** (MENU), and select **■** (Edit) by pressing **■** (▲/▼), and then press **■** (▶).

Press **■** (MENU), and select **■** (Edit) by pressing **■** (▲/▼), and then press **■** (▶).

Press **■** (MENU), and select **■** (Edit) by pressing **■** (▲/▼), and then press **■** (▶).

Press **■** (MENU), and select **■** (Edit) by pressing **■** (▲/▼), and then press **■** (▶).

Press **■** (MENU), and select **■** (Edit) by pressing **■** (▲/▼), and then press **■** (▶).

Press **■** (MENU), and select **■** (Edit) by pressing **■** (▲/▼), and then press **■** (▶).

Press **■** (MENU), and select **■** (Edit) by pressing **■** (▲/▼), and then press **■** (▶).

Press **■** (MENU), and select **■** (Edit) by pressing **■** (▲/▼), and then press **■** (▶).

Press **■** (MENU), and select **■** (Edit) by pressing **■** (▲/▼), and then press **■** (▶).

Press **■** (MENU), and select **■** (Edit) by pressing **■** (▲/▼), and then press **■** (▶).

Press **■** (MENU), and select **■** (Edit) by pressing **■** (▲/▼), and then press **■** (▶).

Press **■** (MENU), and select **■** (Edit) by pressing **■** (▲/▼), and then press **■** (▶).

Press **■** (MENU), and select **■** (Edit) by pressing **■** (▲/▼), and then press **■** (▶).

Press **■** (MENU), and select **■** (Edit) by pressing **■** (▲/▼), and then press **■** (▶).

Press **■** (MENU), and select **■** (Edit)