

Compact Component System

Operating Instructions



CMT-T1

WARNING

To prevent fire or shock hazard, do not expose the unit to rain or moisture.

To avoid electrical shock, do not open the cabinet. Refer servicing to qualified personnel only

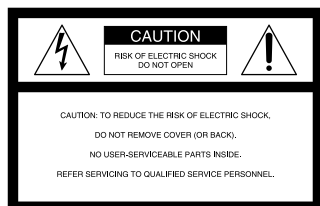

This symbol is intended to alert the user to the presence of uninsulated "dangerous voltage" within the product's enclosure that may be of sufficient magnitude to constitute a risk of electric shock to persons.



This symbol is intended to alert the user to the presence of important operating and maintenance (servicing) instructions in the literature accompanying the appliance.

**Owner's Record**

The model and serial numbers are located at the rear of the unit. Record the serial number in the space provided below. Refer to them whenever you call upon your Sony dealer regarding this product.

Model No. CMT-T1

Serial No. _____

INFORMATION

This equipment has been tested and found to comply with the limits for a Class B digital device, pursuant to Part 15 of the FCC Rules. These limits are designed to provide reasonable protection against harmful interference in a residential installation. This equipment generates, uses, and can radiate radio frequency energy and, if not installed and used in accordance with the instructions, may cause harmful interference to radio communications. However, there is no guarantee that interference will not occur in a particular installation. If this equipment does cause harmful interference to radio or television reception, which can be determined by turning the equipment off and on, the user is encouraged to try to correct the interference by one or more of the following measures:

- Reorient or relocate the receiving antenna.
- Increase the separation between the equipment and receiver.
- Connect the equipment into an outlet on a circuit different from that to which the receiver is connected.
- Consult the dealer or an experienced radio/TV technician for help.

CAUTION

You are cautioned that any change or modifications not expressly approved in this manual could void your authority to operate this equipment.

The use of optical instruments with this product will increase eye hazard.

Note to CATV system installer:

This reminder is provided to call CATV system installer's attention to Article 820-40 of the NEC that provides guidelines for proper grounding and, in particular, specifies that the cable ground shall be connected to the grounding system of the building, as close to the point of cable entry as practical.

Welcome!

Thank you for purchasing the Sony Compact Component System. This stereo system is packed with fun features. Here are just a few:

- The CD jacket-size front panel of each component that lets you stack or place the components as you like
- DBFB (Dynamic Bass Feedback) system that boosts low frequency range audio to provide deep, powerful bass through the full range bass reflex speakers
- A preset feature that lets you store and recall up to 20 FM stations, 10 AM stations.
- A timer that lets you set the CD player, tape player or radio to turn on and off whenever you want
- A remote that lets you control the music from your seat
- An optical output jack for digital recording

About the CMT-T1 system

The system is composed of:

- Tuner CD player : HCD-T1
- Active speaker system : SA-N1
- Stereo cassette deck : TC-TX1

Table of Contents

Chapter 1: Setting Up

- Connecting the Stereo 4
- Inserting the Batteries 6
- Setting the Clock 6

Chapter 2: the CD Player

- Playing a CD (normal play) 7
- Playing Tracks in Random Order (shuffle play) 8
- Playing Tracks in the Desired Order (program play) 8
- Playing Tracks Repeatedly (repeat play) 9

Chapter 3: the Radio

- Listening to the Radio 10
- Presetting Radio Stations 11
- Listening to the Preset Radio Stations 11

Chapter 4: the Tape Player

- Playing a Tape 12
- Recording a CD Automatically 12
- Recording a CD, etc., Manually 13
- Recording a CD in the Specified Track Order (program edit) 14

Chapter 5: Sound Adjustment

- Adjusting the Balance of the Speakers 15
- Reinforcing Bass (DBFB) 15
- Listening with the Surround Feature 16

Chapter 6: Additional Features

- Falling Asleep to Music 17
- Waking Up to Music 17
- Timer-Recording Radio Programs 18
- Connecting Optional Equipment 19

For Your Information

- Precautions 20
- Troubleshooting Guide 20
- Maintenance 21
- Specifications 21
- Index to Parts and Controls 22

Index 23

Chapter 1: Setting up

Connecting the Stereo

Inserting the batteries

Setting the Clock

EN

4

Connecting the Stereo

Use the illustrations below to connect your stereo.

STEP 1 Connecting the Flat Cord

Connect the tuner CD player and the stereo cassette deck with the flat cord (supplied) pushing in the connector until it clicks.

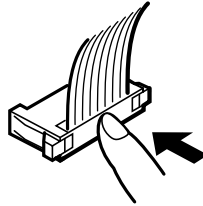

To disconnect the flat cord

Pull out the connector of the flat cord while pressing its sides. Do not pull the flat cord itself.

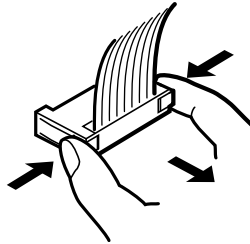

STEP 2 Connecting the Right Speaker

Connect the right speaker to the tuner CD player with the audio cord (supplied) and house current lead.

Connecting the audio cord

Connect firmly the white plug to the white (L) jack and the red plug to the red (R) jack.

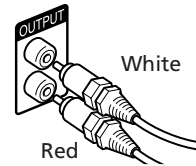

Connecting house current lead of the right speaker

Connect house current lead of the right speaker to AC OUTLET on the rear panel of the tuner CD player.

STEP 3 Connecting the Left Speaker

Connect the left speaker to the right speaker with the speaker cable (supplied). Be sure to keep the speaker cable away from the antennas.

Gray cord to ⊕ (red)

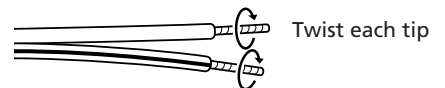

Black-lined cord to ⊖ (black)

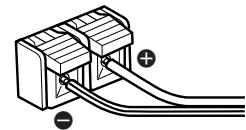

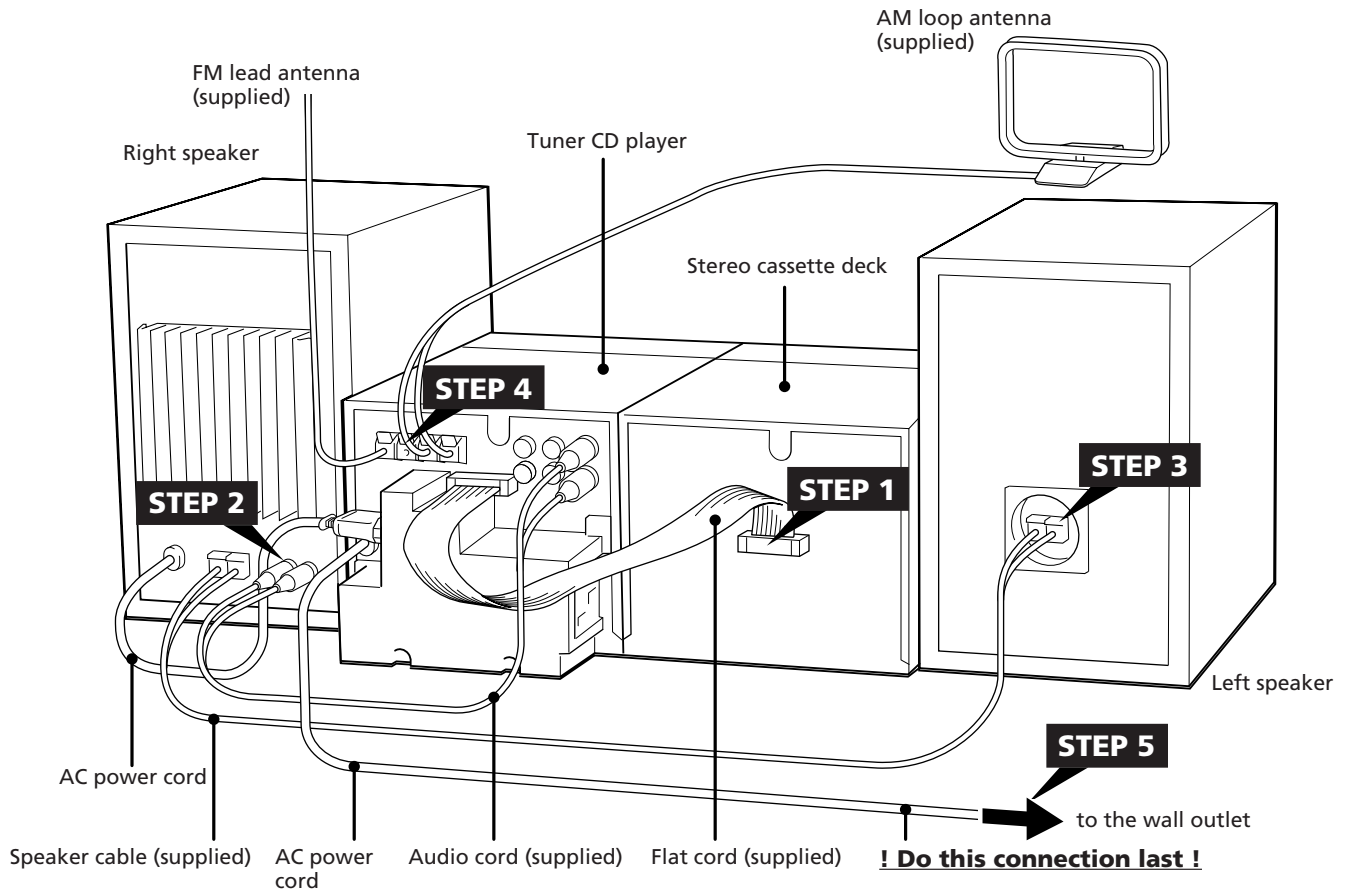

STEP 4 Connecting the Antennas

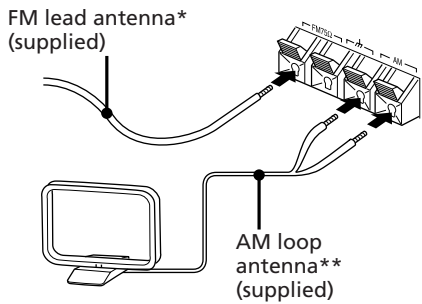

* Fix it to the place for optimum reception.
**Orient it toward the direction for optimum reception.

To improve the reception
Connect an external antenna (p.19).

To set up the AM loop antenna



STEP 5 Connecting the Power

Connect the AC power cord of the tuner CD player to the wall outlet after you have made all the above connections.

Note
• You can remove the front net from the speaker.

Inserting the batteries

Insert two size AA R6 batteries into the supplied remote.

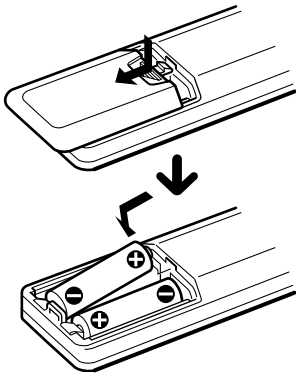

Battery life

You can expect the remote to operate for about six months using Sony SUM-3 (NS) batteries before the batteries run down. When the batteries no longer operate the remote, replace both batteries with new ones.

To avoid battery leakage

If you are not going to use the remote for a long time, remove the batteries to avoid damage caused by corrosion from battery leakage.

Setting the Clock

You need to set the clock before using the timer function.

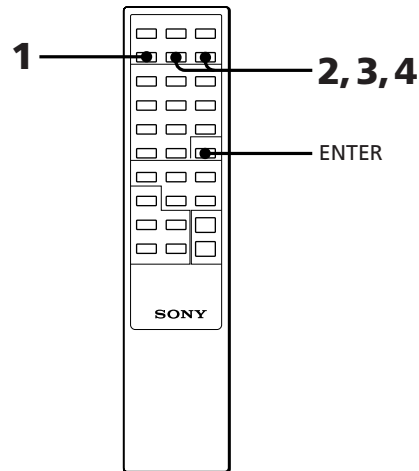

- 1 Press TIMER SET.
- 2 Press TIMER+ or – to display “CLOCK” and press ENTER.
The hour indication begins flashing.



- 3 Set the current hour by pressing TIMER+ or – and press ENTER.
The minute indication begins flashing.



- 4 Set the current minute by pressing TIMER+ or – and press ENTER.
The clock starts operating.

To correct the clock setting

Repeat steps 1 to 4.

About the time indication

- The built-in clock shows the time in the display when you press POWER to turn off the power.
- The upper dot of the “:” in the time display flashes for the 0 to 29 seconds of the minute and the lower dot flashes for the 30 to 59 seconds.

Chapter 2: the CD Player

Playing a CD (normal play)

Playing Tracks in Random Order (shuffle play)

Playing Tracks in the Desired Order (program play)

Playing Tracks Repeatedly (repeat play)

Playing a CD (normal play)

You can play CDs in four modes: normal, shuffle, program and repeat. The mode determines which tracks (songs) to play, in which order and whether or not they will repeat.

Also, you can play 12 cm and 8 cm CDs. When you play an 8-cm CD, place it without an adaptor on the inner circle of the disc tray.

Before you play the CD, decrease the sound level by pressing VOL -. This will prevent damage to the speakers.

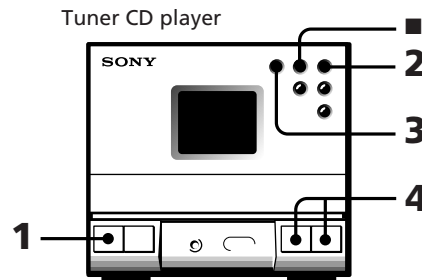

- 1 Press POWER.
- 2 Press \blacktriangle (open/close) and place a CD on the CD tray.

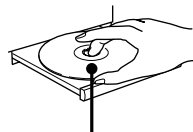

with the label side up

- 3 Press $\blacktriangleright\|\blacktriangleright$ (play) (or \blacktriangleright on the remote). The disc tray closes and the first track starts playing.



- 4 Press VOL + or - to adjust the sound level.

To	Press
Stop play	\blacksquare
Pause	$\blacktriangleright\ \blacktriangleright$ (or $\ \blacktriangleright^*$) To resume play, press here again.
Remove the CD	\blacktriangle

* Remote

One Touch Play feature

Press $\blacktriangleright\|\blacktriangleright$ (or \blacktriangleright on the remote) when the power is off or you are listening to another source.

As long as a CD is in the player, you will be able to listen to the CD without pressing any other buttons.

To find the beginning of a track – Automatic Music Sensor (AMS)

You can locate the beginning of a track while the track is playing or while it is in pause mode.

To locate the beginning of the current or preceding track, press $\blacktriangleleft\blacktriangleleft\blacktriangleleft$ (or \blacktriangleleft on the remote) until you find the desired track.

To locate the beginning of the succeeding track, press $\blacktriangleright\blacktriangleright\blacktriangleright$ (or \blacktriangleright on the remote) until you find the desired track.

To find a point in a track

You can find a particular point in a track while playing or pausing a CD. Use the buttons on the player to operate this feature. This operation is not possible with the remote.

To Search	Operation
Forward while listening	Hold down $\blacktriangleright\blacktriangleright\blacktriangleright$ and release it at the desired point.
Backwards while listening	Hold down $\blacktriangleleft\blacktriangleleft\blacktriangleleft$ and release it at the desired point.
Quickly without listening while checking the playing time in the display	Hold down $\blacktriangleright\blacktriangleright\blacktriangleright$ or $\blacktriangleleft\blacktriangleleft\blacktriangleleft$ during pause and release it at the desired point.

Note

If the CD reaches the end while you are searching quickly without listening, "OVER" appears in the display. Press $\blacktriangleleft\blacktriangleleft\blacktriangleleft$ (\blacktriangleleft on the remote) to go back.

To check the total number of tracks and total playing time

Press DISPLAY on the remote while the player is in stop mode. The indications appear for a few seconds.

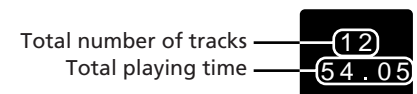

To check the remaining time

Press DISPLAY on the remote repeatedly while playing a CD. Each time you press DISPLAY, the display changes as follows.

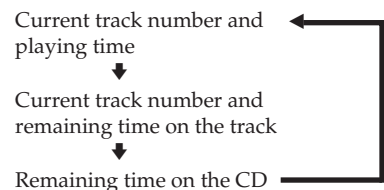

Playing Tracks in Random Order (shuffle play)

You can play all the tracks on the CD in random order. Use the buttons on the remote to do this operation.

Tuner CD Player

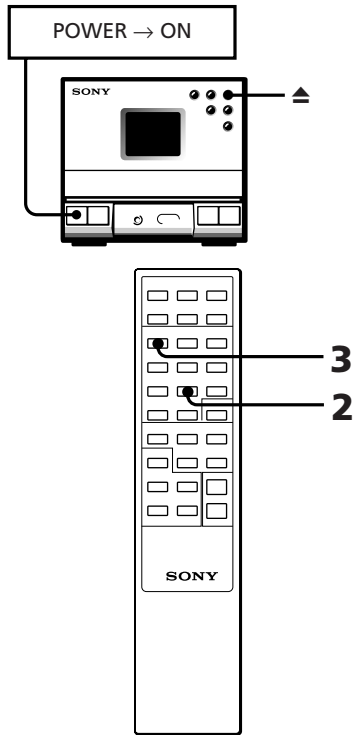

- 1 Press ▲ (open/close) and place a CD on the CD tray.
- 2 Press TUNING/PLAY MODE repeatedly until "SHUFFLE" appears in the display.
- 3 Press ►. "▶" appears and then all the tracks play in random order.

To cancel shuffle play

Press TUNING/PLAY MODE. "SHUFFLE" disappears, and tracks continue playing in their original order.

If you press TUNING/PLAY MODE during normal play

You can play all the tracks on the CD in random order.

To skip an undesired track

Press ►►. You cannot go back to the preceding track by pressing ◀◀.

Playing Tracks in the Desired Order (program play)

You can program up to 24 tracks to play in any order you choose. You can do this by designating the tracks in the order you want them to play.

Tuner CD Player

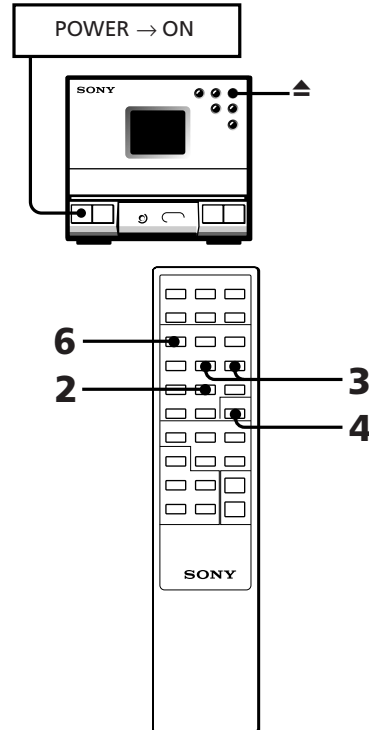

- 1 Press ▲ (open/close) and place a CD on the CD tray.
- 2 Press TUNING/PLAY MODE repeatedly until "PGM" appears in the display.
- 3 Press ◀◀ or ►► until the desired track number is displayed. The total playing time including the chosen track flashes in the display. (The program is not entered at this time.)

Track number

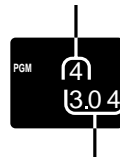

Total playing time

- 4 Press ENTER. The program number appears for about a second, and the total playing time lights up.
- 5 Repeat steps 3 and 4 to program the remaining tracks you want to play in the order you want them to play.

- 6 Press ►. All the tracks you chose play in the order you designated.

To cancel the program play

Press TUNING/PLAY MODE until "PGM" disappears.

To change the program

To	Operation
Add a track at the end of the program	During stop, do steps 3 – 5.
Erase the entire program	During stop, press ■ on the player.

After all the programmed tracks have been played

The program order remains in the CD player's memory. You can listen to the same program by just pressing ►.

Notes

- Once you open the CD tray, the program is erased.
- If the total program time has exceeded 100 minutes, the order of the program is displayed instead of the total playing time.
- If you try to program more than 24 tracks, "FULL" is displayed.

Playing Tracks Repeatedly (repeat play)

You can choose between two different repeat play modes. One repeats all the tracks in the current play mode; the other repeats a single track.

Use the buttons on the remote to do this operation.

Tuner CD Player

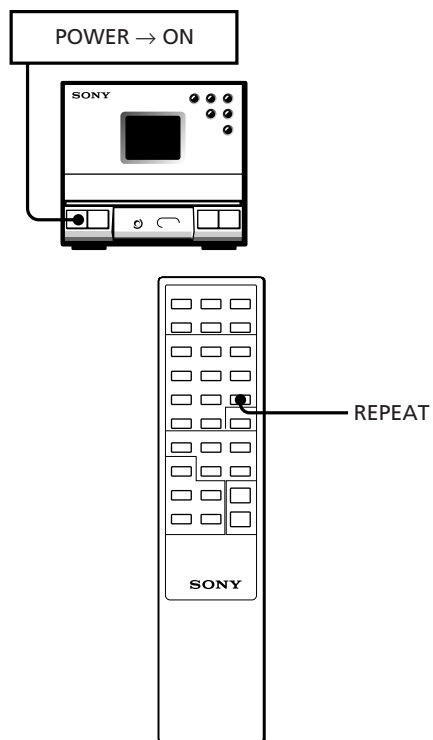

Repeating all the tracks (in any play mode)

Press REPEAT.

"REPEAT" appears in the display, and the tracks play repeatedly in the current play mode.

Repeating a single track (in normal play mode only)

While the desired track is being played, press REPEAT repeatedly until "REPEAT 1" appears in the display.

To cancel repeat play

Press REPEAT repeatedly until "REPEAT" or "REPEAT 1" disappears from the display.

Chapter 3: the Radio

- Listening to the Radio
- Presetting Radio Stations
- Listening to the Preset Radio Stations

EN
10

Listening to the Radio

You can have the tuner automatically scan and tune in the stations with clear signals. This feature saves you time in searching for stations with clear signals. However, you will have to manually tune in stations with weak signals that are skipped by automatic tuning.

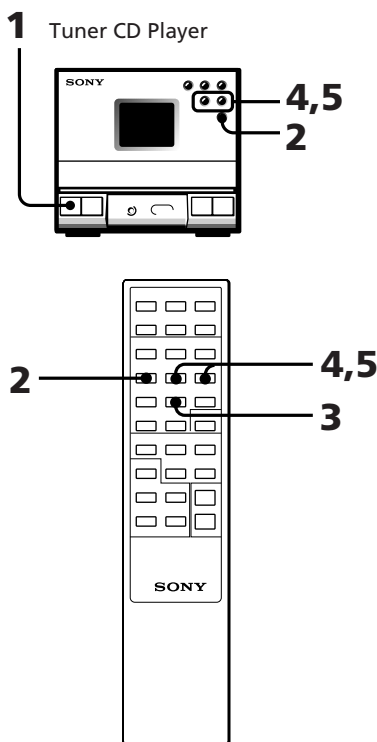

- 1 Press POWER.
- 2 Press BAND repeatedly until the band you want appears in the display. As you press BAND, the band changes as follows:
FM ↔ AM
- 3 Press TUNING/PLAY MODE until "AUTO" appears in the display.
- 4 Press TUNING +/- to tune in the desired station. To tune in a higher frequency station, press TUNING +, and to tune in a lower frequency station press TUNING -. The tuner starts scanning stations automatically, and stops when it finds a clear station. "TUNED" appears in the display. "STEREO" also appears if the FM station tuned in is broadcasting in stereo.

- 5 If you do not want to listen to the station selected, press TUNING +/- again to restart the scan.

When the desired station is not tuned in

Automatic tuning may skip a station with a weak signal. Tune in the station manually.

- 1 Press TUNING/PLAY MODE repeatedly until "MANUAL" appears in the display.
- 2 Keep pressing TUNING +/- until the desired station is tuned in.

To improve AM broadcast reception

Reorient the supplied AM loop antenna for AM.

To change the AM tuning interval

The AM tuning interval is preset to 10 kHz (9 kHz in some areas) in the factory. If you need to change the interval, do as follows:

- 1 Turn on the power.
- 2 Change the band to AM.
- 3 Turn off the power.
- 4 Turn the power back on while pressing TUNING+.

After changing the tuning interval, reset the preset AM radio stations.

When an FM program is not received clearly

Press STEREO/MONO until "MONO" appears in the display. There will be no stereo effect, but the reception will improve. Press STEREO/MONO again to restore the stereo effect.

One Touch Play feature

Press BAND when the power is off or you are listening to another source. You will be able to listen to the last received station without pressing any other buttons.

Presetting Radio Stations

You can store radio frequencies in the tuner's memory to tune in your favorite stations quickly. You can preset up to 20 FM stations and 10 AM stations. Use the buttons on the remote to do this operation.

Tuner CD Player

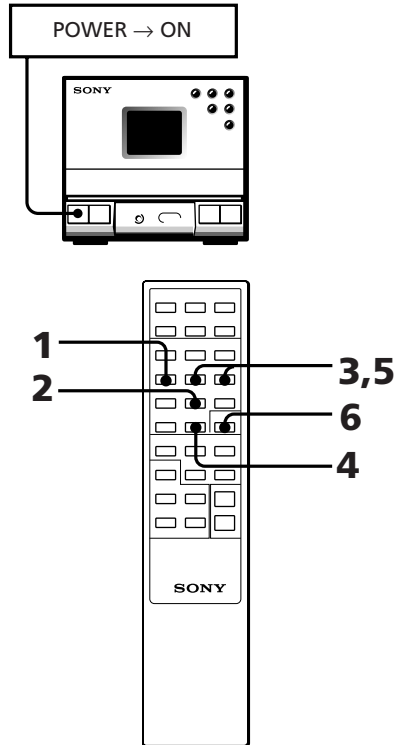

- 1** Press BAND repeatedly until the desired band appears in the display.
FM ↔ AM
- 2** Press TUNING/PLAY MODE repeatedly until "MANUAL" or "AUTO" appears in the display.
- 3** Press TUNING +/- to tune in the station you want to store.
- 4** Press MEMORY.
"MEMORY" and the preset channel number appear in the display.
- 5** Decide on a preset channel number for the radio station (1 to 20 for FM, 1 to 10 for AM). Press TUNING +/- to display the preset channel number you have decided on.
- 6** Press ENTER.
The station is stored at the preset channel number you have decided on.
- 7** Repeat steps 3 to 6 for each station you want to store.

To erase a stored station

Store a new station on the preset channel number of the station you want to erase. This will erase the old station and replace it with the new station.

Note

The preset stations will not be erased unless you store a new station to replace the old ones even if you disconnect the power source.

To change the frequency display to the preset channel display

During listening to a preset radio station, press DISPLAY on the remote. Each time you press DISPLAY, the frequency or the preset channel number appears in the display.

Listening to the Preset Radio Stations

Once you have preset the stations, you can quickly tune in your favorite stations.

Tuner CD Player

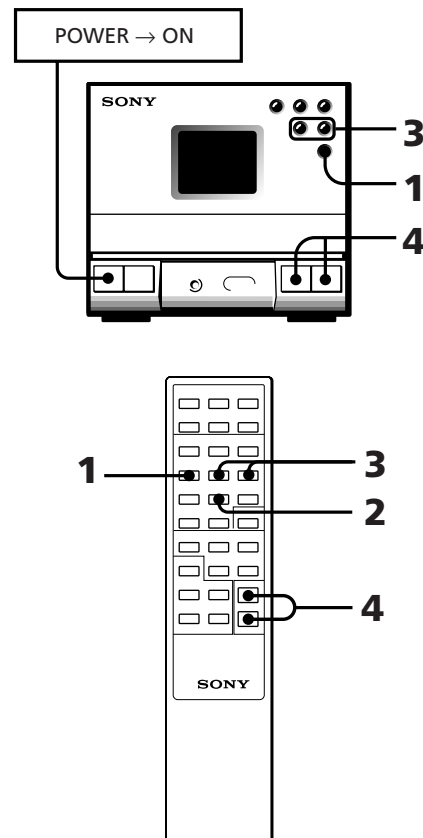

- 1** Press BAND repeatedly until the desired band appears in the display.
FM ↔ AM
- 2** Press TUNING/PLAY MODE repeatedly until "PRESET" appears in the display.
- 3** Press TUNING +/- to tune in a preset station.
The preset channel number appears, then the station frequency appears and the broadcast can be heard.
- 4** Press VOL +/- to adjust volume.

Chapter 4: the Tape Player

Playing a Tape

Recording a CD Automatically

Recording a CD, etc., Manually

Recording a CD in a Specified Track Order (program edit)

EN
12

Playing a Tape

You can use TYPE I (normal), TYPE II (CrO₂) and TYPE IV (metal) tapes. When you insert a tape, the deck detects the tape type automatically.

Tuner CD player

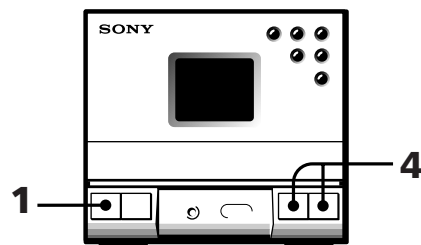

Stereo cassette deck

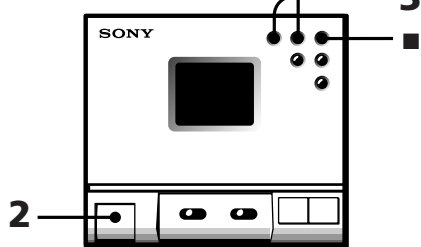

- 1 Press POWER.
- 2 Press ▲ EJECT to open the tape compartment and insert a recorded tape.

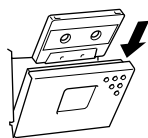

- 3 Press ► to play the front side. To play the reverse side, press ◀.
- 4 Press VOL +/- to adjust the volume.

To stop play

Press ■.

To	Operation
Pause	Press on the deck. To resume play, press here again.
Find the beginning of the current or succeeding track	During play, press ◀◀ or ▶▶ on the deck.
Fast forward or rewind	During stop, press ◀◀ or ▶▶ on the deck.
Play one side of the tape	Slide DIRECTION to ⇄.
Play both sides repeatedly*	Slide DIRECTION to ↻.

* The deck stops automatically after repeating the sequence five times.

When listening to a tape recorded with the Dolby* B-type noise reduction system

Slide the DOLBY NR switch to ON. Dolby noise reduction system reduces tape hiss noise in low-level high-frequency signals.

* Dolby noise reduction manufactured under license from Dolby Laboratories Licensing Corporation. "DOLBY" and double-D symbol  are trademarks of Dolby Laboratories Licensing Corporation.

One Touch Play feature

Press ► or ◀ when the power is off or you are listening to another source.

As long as a tape is in the deck, you will immediately be able to listen to the tape without pressing any other buttons. If a tape is not in the deck, only the power will be turned on.

Recording a CD Automatically

You can record a CD on a tape quickly by using the CD SYNC button. Use the buttons on the CD player and the cassette deck. Before recording, make sure the tabs on the cassette have not been removed.

Tuner CD player

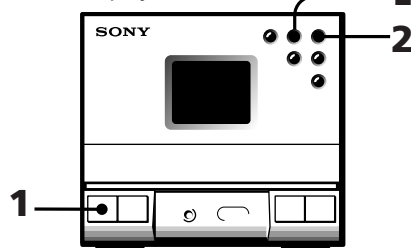

Stereo cassette deck

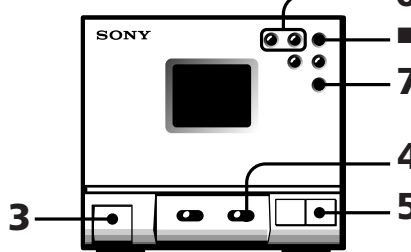

- 1 Press POWER.
- 2 Press ▲ and place a CD.
- 3 Press ▲ EJECT and insert a blank tape.

- 4 Slide DIRECTION to select dual or single-sided recording.

To record on	Slide DIRECTION to
One side	↔
Both sides*	↻

* Recording always stops at the end of the reverse side. Be sure to start from the front side.

- 5 Press CD SYNC.
The cassette deck stands by for recording, and the CD player stands by for playing.
- 6 Press ▶ or ◀ to select the tape side to start recording on.
To start from the front side, press ▶.
To start from the reverse side, press ◀.
(Recording will be made only on the reverse side.)
- 7 Press II.
Recording starts. After about 10 seconds, the CD starts playing.

To stop recording

Press ■ on the deck or the CD player.

To activate DOLBY NR

When you want to reduce the hiss noise in low-level high-frequency signals, slide the DOLBY NR switch to ON after step 4.

About CD SYNC (synchronized) recording

With this feature, the cassette deck records a CD synchronizing with the length of the tracks on the CD, so you do not have to worry about the tape direction or remaining time while recording. This stereo system uses the Fade Synchronized recording feature. With this feature, the deck slowly fades out a recording so that a track is not abruptly cut off at the end of the tape. If the tape reaches the end of its front side while recording a track, the deck re-records it automatically after rewinding the tape to the beginning of the track. This time, the track is recorded with a fadeout at the end of the tape. (Recording ends at this point if it is a single-sided recording.)

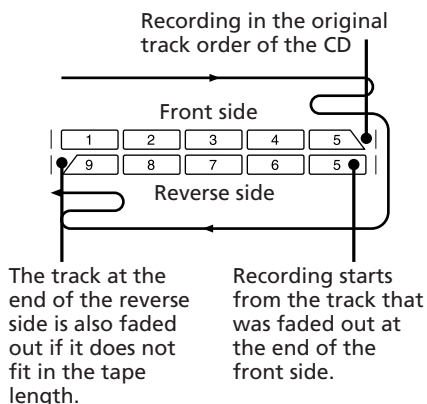

When the track order has been programmed and the total length of the tracks to be recorded is shorter than the length of one side of the tape, the unit automatically operates as follows:

When the CD player is paused, the deck continues recording silence until it reaches the end of the front side; then it reverses the tape and starts recording.

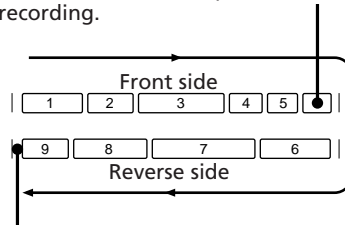

Once all of the selected tracks have been recorded, the deck records about four seconds of silence and then stops.

Recording a CD, etc., Manually

You can record a CD as you like, for instance, record just the songs you want, or you can record from any point on the tape.

Tuner CD player

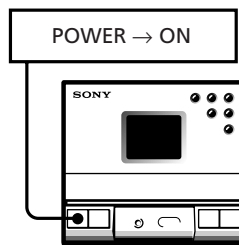

Stereo cassette deck

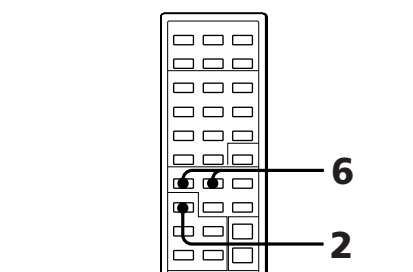
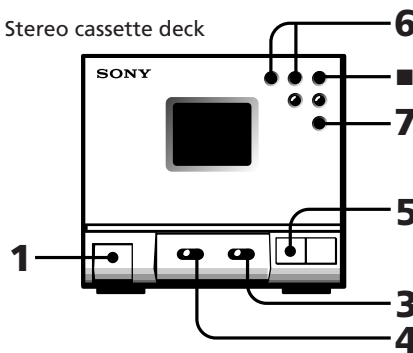

- 1 Press ▲ EJECT and insert a blank tape.

- 2 Press FUNCTION repeatedly until the source you want to record appears in the display.

Source	Indication
CD	CD
Radio	TUNER
MD, etc.	PC (or MD)*

- 3 Slide DIRECTION to select dual or single-sided recording.
To record on one side, set to ↔.
To record on both sides, set to ↻.
- 4 When you want to reduce the hiss noise in low-level high-frequency signals, slide DOLBY NR to ON.
- 5 Press ● REC on the deck.
The deck stands by for recording, and the ● REC button lamp and the II button lamp on the deck light up. Either the ▶ or ◀ button lamp lights up, and the other flashes and goes out. If the ▶ or ◀ button lamp does not light up or flash, the corresponding tab on the cassette has been removed. You cannot record on this side.

- 6 Press ▶ or ◀ to select the tape side you want to start recording on.
To start recording on the front side, press ▶.
To start recording on the reverse side, press ◀.
- 7 Press II on the deck.
Recording starts.
When you set the DIRECTION switch to ↻, recording stops at the end of the reverse side.

- 8 Start playing the sound source.

To stop recording

Press ■ on the deck.

*To change indication "PC" to "MD".

You can change source indication "PC" to "MD".

- 1 Press FUNCTION to indicate "PC".
2 Press FUNCTION while pressing ▶▶▶▶/ TUNING +.

Note

If you press FUNCTION while recording, the sound source will be switched to another.

Recording a CD in a Specified Track Order (program edit)

You can adjust the total recording time to the tape length while making a program.

Tuner CD player

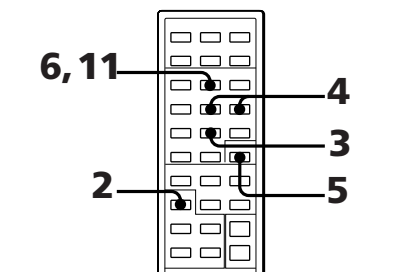
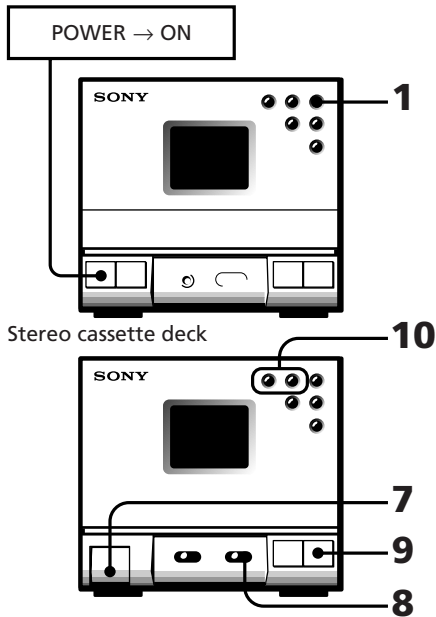

- 1 Press **▲** on the CD player and place a CD.
- 2 Press **FUNCTION** repeatedly until "CD" appears in the display.
- 3 Press **TUNING/PLAY MODE** repeatedly until "PGM" appears in the display.
- 4 Press **◀** or **▶** to choose a track.
- 5 Press **ENTER**. Repeat steps 4 and 5 to program the remaining tracks you want to record on side A in the order you want them to be recorded.
- 6 Press **||** on the remote to pause recording at the end of side A. The total recording time "0.00" is displayed. Repeat steps 4 and 5 to program the remaining tracks you want to record on side B in the order you want them to be recorded.

- 7 Press **▲** EJECT on the deck and insert a blank tape.
- 8 Slide **DIRECTION** to select dual or single-sided recording. To record on one side, set to **↔**. To record on both sides*, set to **↔↔**.
* Recording always stops at the end of the reverse side. Be sure to start from the front side.
- 9 Press **CD SYNC**. The deck stands by for recording, and the CD player stands by for playing.
- 10 Press **▶** or **◀** to select the tape side you want to start recording on. To start recording on the front side, press **▶**. To start recording on the reverse side, press **◀**.
- 11 Press **||** to release recording pause. Recording starts. After about 10 seconds, the CD starts playing. When you program to record on side B, the CD will pause after completing the recording on side A. The deck continues recording silence until it reaches the end of side A, then it reverses the tape and starts recording on side B. Once all of the selected tracks have been recorded, the deck records about 4 seconds of silence and then stops.

To cancel program edit

Press **TUNING/PLAY MODE** until "PGM" disappears.

Notes

- If the last portion of the track is recorded on the leader at the end of the tape, recording may not be made completely.
- When programming for side B after pausing at the end of side A, make sure the tracks programmed for side A do not exceed the length of a single side. Otherwise recording cannot be made correctly.

To start recording partway through a tape

Play or record on the tape for more than a few seconds, then press **CD SYNC**. As soon as you start recording, CD starts playing. When you press **CD SYNC** after pressing **▲** EJECT to insert a tape, CD play will start 10 seconds after recording starts. This will happen when recording on any part of the tape because the stereo system is designed to prevent recording on the leader at the beginning of the tape.

Chapter 5: Sound Adjustment

Adjusting the Balance of the Speakers

Reinforcing Bass (DBFB)

Listening with Surround Feature

Adjusting the Balance of the Speakers

You can adjust the balance of the sound from the speakers to correct the stereo imaging when the speaker position is not symmetrical.

Use the buttons on the remote to do this operation.

Tuner CD Player

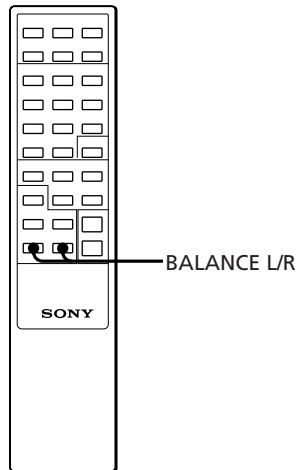
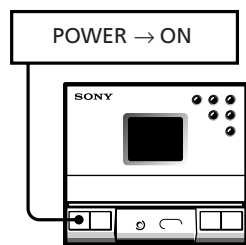

To increase the relative strength of the right speaker, press BALANCE R.

Each time you press BALANCE R, the display changes as follows:

10 LEFT → 9 LEFT → → 1 LEFT → CENTER → 1 RIGHT → 2 RIGHT → → 10 RIGHT

To increase the relative strength of the left speaker, press BALANCE L.

Each time you press BALANCE L, the display changes in reverse order to the above.

To listen through the headphones

Connect the headphones to the PHONES jack. No sound will come from the speakers.

Reinforcing Bass (DBFB)

DBFB (Dynamic Bass Feedback) feature intensifies low frequency sound for richer bass reproduction.

You can select one of the two levels of DBFB: "DBFB1" or "DBFB2". "DBFB2" is more effective than "DBFB1".

Tuner CD Player

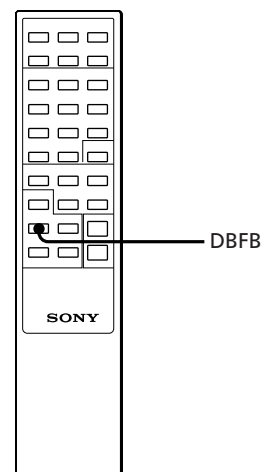
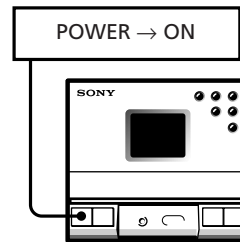

Press DBFB repeatedly until "DBFB1" or "DBFB2" appears in the display.

Each time you press DBFB, the display changes as follows:

DBFB1 → DBFB2 → OFF

Note

When the Surround and DBFB features are set to OFF, you can enjoy almost the same sound as the CD source (Source Direct feature).

Listening with the Surround Feature

With this feature, you can create the atmosphere of a movie theater or concert hall. Select one of the two levels of the Surround feature: "SURR1" and "SURR2". "SURR2" is more effective than "SURR1".

Tuner CD Player

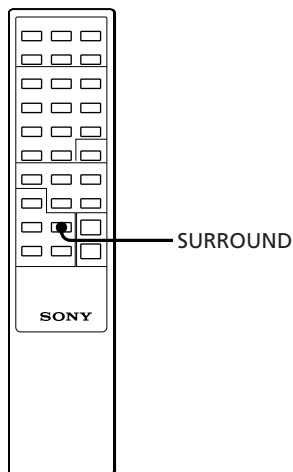
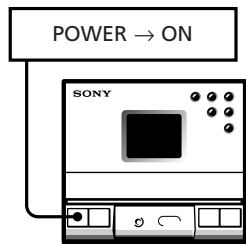

EN
16

Press SURROUND repeatedly until "SURR1" or "SURR2" appears in the display.

Each time you press SURROUND, the display changes as follows:



Note

When the Surround and DBFB features are set to OFF, you can enjoy almost the same sound as the CD source (Source Direct feature).

Chapter 6: Additional Features

Falling Asleep to Music

Waking Up to Music

Timer-Recording Radio
Programs

Connecting Optional
Equipment

Falling Asleep to Music

You can set the stereo system to turn off automatically so you can go to sleep to music.

Before setting sleep timer, make sure the clock has been set correctly.

Tuner CD Player

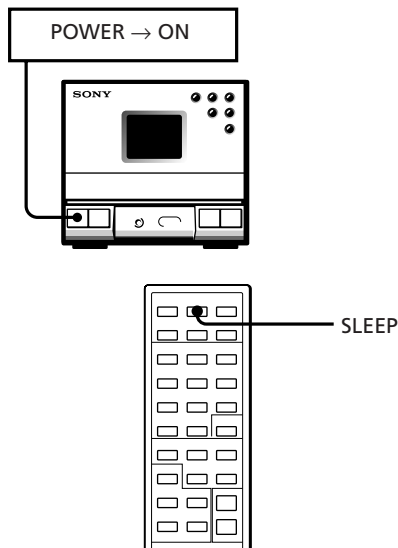

1 Play your favorite sound source (a tape, the tuner or CD).

2 Press SLEEP while the source is playing to choose how long you want the music to play. "SLEEP" and minutes indication appear in the display. Each time you press SLEEP, the indication decreases by 10 minutes from 90 to 10. The power will turn off after the length of time you chose.

90 → 80 → 70 → → 20 → 10 → OFF

To cancel the sleep timer

Press SLEEP repeatedly until "SLEEP OFF" appears in the display.

To check the remaining time before the sleep timer turns off the system

Press SLEEP once.

The remaining time appears in the display for several seconds.

To change the preset time while the sleep timer is on

Press SLEEP several times until the desired length of time indication appears.

Note

While the sleep timer is activated, the daily and recording timer functions do not work.

Waking Up to Music

You can wake up to music at the preset time. You only need to set the timer once. The preset timer activates at the same time every day. Before setting the wake up timer, make sure the clock has been set correctly.

To wake up to the sound of the radio, be sure to preset the station you want to listen to beforehand. (See "Presetting Radio Stations".)

Tuner CD Player

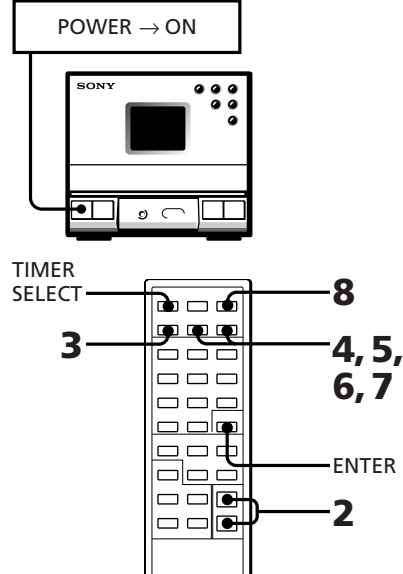

1 Prepare the sound source.

Source	Preparation
CD	Insert a CD. If you want to play it from a desired track, do the necessary procedures for programed CD play (p.8).
Radio	Tune in the desired preset station.
Tape	Insert a tape with the side you want to play facing towards you, and press ► to start playing from the front side.

2 Press VOL +/- to adjust the volume.

3 Press TIMER SET.

4 Press TIMER +/- to display "DAILY", and press ENTER. The hour indication flashes in the display.



continue to next page →

→continued

- 5** Set the time you want the music to come on.
Press **TIMER +/-** to set the hour, and press **ENTER**.
The minute indication flashes.
Set the minute in the same way and press **ENTER**.
The hour indication for the turn-off time appears.



- 6** Set the time you want the music to go off.
Press **TIMER +/-** to set the hour, and press **ENTER**.
The minute indication flashes.
Set the minute in the same way and press **ENTER**.
The source indication flashes.



- 7** Press **TIMER +/-** to select the source, and press **ENTER**.

Source	Indication
CD	CD
Radio	TUNER
Tape	TAPE
MD, etc.	PC (or MD)*

The preset items appear in the display sequentially.

*see page 13

- 8** Press **SYSTEM POWER** to turn off the system.
At the preset time, the power will go on and the music will play. At the turn-off time, the power will go off again.

To cancel the timer

Press **TIMER SELECT** repeatedly until "OFF" appears in the display instead of "DAILY".

To set the timer with the same items

Press **TIMER SELECT** to display "DAILY", and press **SYSTEM POWER** to turn off the system.
Once you set the timer, you do not have to set the same items again.

To check the timer settings

Press **TIMER SELECT** until "DAILY" disappears and appears in the display again.
The preset items appear sequentially.

To change timer settings

Repeat steps 1 to 8.

Timer-Recording Radio Programs

You can set the timer to record the radio. This timer works only once for each setting. Preset the station beforehand. (See "Presetting Radio Stations".) Make sure the clock is set correctly.

Note

You cannot control with this player the power on/off and recording start/stop of the recorder connected to the MD OUT jacks on the rear. Complete the preparation for timer recording on the recorder.

Tuner CD player

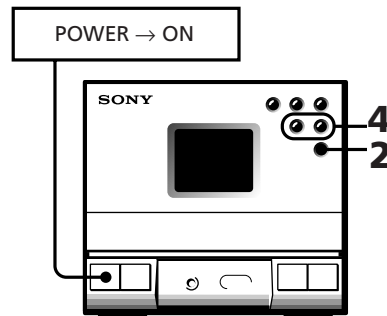

Stereo cassette deck

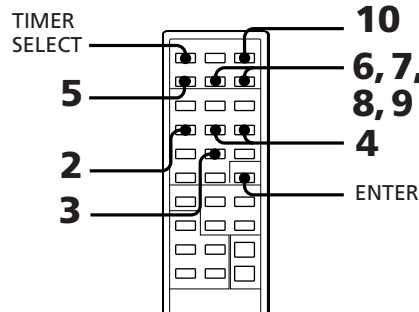
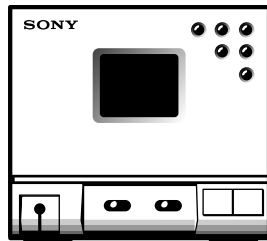

- 1** Insert a blank tape with the side you want to record facing towards you, and press **▶** to start recording from the front side.
(Prepare the recorder connected to the MD OUT jacks on the rear for timer recording.)

- 2** Press **BAND** repeatedly until the band you want appears in the display.
3 Press **TUNING/PLAY MODE** until "PRESET" appears in the display.
4 Press **TUNING +/-** to tune in the preset station.
5 Press **TIMER SET**.
6 Press **TIMER +/-** to display "REC", and press **ENTER**.
The hour indication flashes.



- 7** Set the time you want to start recording. Press **TIMER +/-** to set the hour, and press **ENTER**.
The minute indication flashes.
Set the minute in the same way, and press **ENTER**.
The hour indication for the turn-off time flashes.



- 8** Set the time you want to stop recording. Press **TIMER +/-** to set the hour, and press **ENTER**.
The minute indication flashes.
Set the minute in the same way and press **ENTER**.
"TO TAPE" or "TO MD" flashes.



- 9** Press **TIMER +/-** to select what you want to record on, and press **ENTER**.
To record on a tape, display "TO TAPE".
To record on an MD, etc., display "TO MD".
The preset items appear in the display sequentially.

- 10** Press **SYSTEM POWER** to turn off the system.
At the preset time, the power will go on and recording starts. At the turn-off time, the power will go off again.
At the preset time, the sound level is automatically set to the minimum and will be the same level after the turn off time.

To cancel the timer

Press **TIMER SELECT** repeatedly until "OFF" appears in the display instead of "REC".

To set the timer with the same items

Press **TIMER SELECT** to display "REC", and press **POWER** to turn off the system. Once you set the timer, you do not have to set the same items again.

To check the timer settings

Press **TIMER SELECT** until "REC" disappears and appears in the display again. The preset items appear sequentially.

To change timer settings

Repeat steps 1 to 10.

Connecting Optional Equipment

Connecting an MD, DAT deck, etc.

To make a digital recording with an MD, DAT deck, etc.

Connect the **DIGITAL (OPTICAL) OUTPUT** jack on the rear panel of the tuner CD player to a recorder, deck, etc. that has an optical connector.

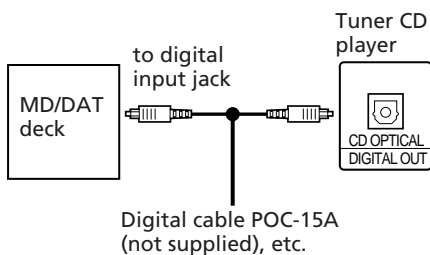

To make an analog recording with an MD, DAT, VCR deck, etc.

Connect the **PC/MD IN/OUT** jacks (phono jacks) on the rear panel of the stereo to an MD, DAT, VCR deck, etc. with the Sony RK-C315 connecting cord (not supplied).

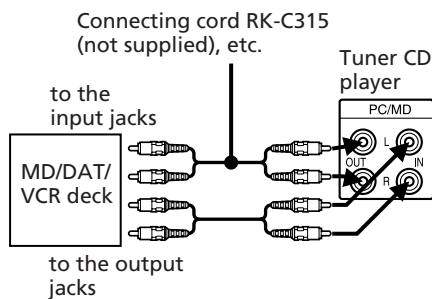

To hear the VCR sound through the connected speakers, connect the **PC/MD IN** jacks on the rear panel of the stereo to the output jacks on the VCR. In this case, connect the plugs to jacks of the same colours.

For details, see the instruction manual for each equipment.

To listen to the sound of the connected equipment

Press **FUNCTION** repeatedly until "PC" (or MD) appears in the display.

Connecting an External Antenna

To improve the FM reception

Connect an external antenna when the signal reception is too weak with the supplied FM lead antenna. Connect an external FM antenna to the FM 75 Ω terminal, using a 75-ohm coaxial cable.

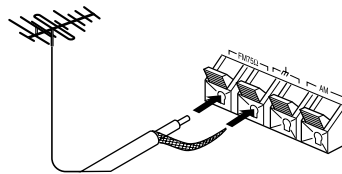

To improve the AM reception

Connect an external antenna if the signal reception is too weak after reorienting the supplied AM loop antenna. Do not disconnect the AM loop antenna. Connect a 6- to 15-meter insulated wire (not supplied) to the AM terminal and extend the other end horizontally at a higher place. Connect the \perp terminal to the earth.

Important

Earth the external antenna against lightning. To avoid a gas explosion, do not connect the earth wire to a gas pipe.

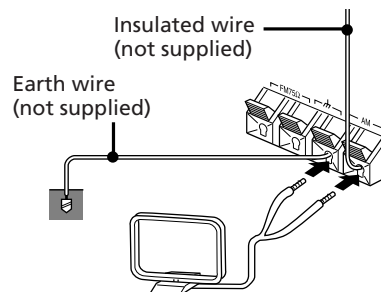

Precautions

Troubleshooting Guide

Maintenance

Specifications

Index to Parts and Controls

Index

Precautions

If you have any questions or problems concerning your stereo system, please consult your nearest Sony dealer.

On safety

- The use of optical instruments with this product will increase eye hazard.
- The unit is not disconnected from the AC power as long as it is connected to the wall outlet, even if the unit itself has been turned off.
- Unplug the system from the AC power if it is not to be used for an extended period of time. To disconnect the AC power cord, pull it out by the plug. Never pull the cord itself.
- Should any solid object or liquid fall into a component, unplug the stereo system and have the component checked by qualified personnel before operating it any further.

On installation

Place the stereo system in a location with adequate ventilation to prevent heat build-up in the stereo system.

On condensation in the CD player component

If the system is brought directly from a cold to a warm location, or is placed in a very damp room, moisture may condense on the lens inside the CD player. Should this occur, the CD player will not operate. Remove the CD and leave the system turned on for about an hour until the moisture evaporates.

To save a tape permanently

To prevent a tape from being accidentally recorded over, break off the cassette tab from side A or B as illustrated. If you later want to reuse the tape for recording, cover the broken tab with adhesive tape.

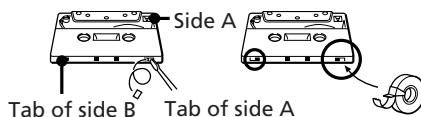

When you are using a TYPE II (CrO₂) or TYPE IV (METAL) cassette, be careful not to cover the detector slots which allow the tape player to automatically detect the type of tape.

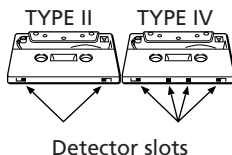

In case colour irregularity is observed on nearby TV screen

With this magnetically shielded type of speaker system, the speakers can be installed near a TV set. However, colour irregularity may still be observed on the TV screen depending on the type of your TV set.

If colour irregularity is observed...

Turn off the TV set once, then turn it on after 15 to 30 minutes.

If colour irregularity is observed again...

Place the speakers farther away from the TV set.

Troubleshooting Guide

If you run into any problem using the stereo, use the following check list after first checking the following two points:

- AC power cord lead is connected firmly.
- The speakers are connected correctly and firmly.

Should any problem persist after you have made the checks below, consult your nearest Sony dealer.

General

There is no sound.

- Press POWER to turn on the stereo.
- Adjust the volume.
- The headphones are connected. Disconnect them.

The left and right sound are reversed.

- Check the speaker connection and speaker placement.

There is severe hum or noise.

- TV or VCR is too close to the stereo system. Move the stereo system away from the TV or VCR.

"AM 0:00" flashes in the display.

- Mains interruption occurred. Set the clock and timer settings again.

CD Player

The CD tray does not close.

- The CD is not placed correctly.

The CD will not play.

- The CD is dirty.
- The CD is inserted label side down.
- The player is in pause mode.
- Moisture condensation has built-up. Leave the system turned on for about an hour until the moisture evaporates.

Play does not start from the first track.

- The CD player is in program or shuffle mode. Press TUNING/PLAY MODE repeatedly until the play mode indication disappears.

Cassette deck

The tape does not record.

- No tape in the tape compartment.
- The tab has been removed from the cassette.
- The tape has reeled to the end.

The tape does not record nor does it play back, or there is a decrease in sound level.

- The heads are dirty. Clean them.
- Magnetic deposits have built-up on the record/playback head*.

There is excessive wow or flutter, or the sound drops out.

- The capstans or pinch rollers are contaminated*.

The tape does not erase completely.

- Magnetic deposits have built-up on the record/playback head*.

Noise increases or the high frequencies are erased.

- Magnetic deposits have built-up on the record/playback head*.

CD Synchronized recording does not start.

- When you set the tape direction to , recording does not start if the tab of either side is removed from the cassette.

*See "Maintenance".

Tuner

"TUNED" flashes in the display.

- Adjust the antenna.

"STEREO" flashes in the display.

- Adjust the antenna.

Severe hum or noise.

- Adjust the antenna.
- The signal strength is too weak. Connect the external antenna.
- Connect the earth wire.

A stereo FM program cannot be received in stereo.

- When "MONO" appears in the display, press STEREO/MONO on the remote so that "MONO" disappears.
- Adjust the antenna.

Timer

The timer does not function.

- Set the clock correctly.
- AC power has been cut off. While the timer functions, press the POWER switch to turn off the system.
- Make sure "DAILY" or "REC" appears in the display.

Remote

The remote does not function.

- The batteries have run down. Replace both batteries.
- There is an obstacle between the remote and the system. Remove the obstacle.

Maintenance

To clean the tape heads and tape path

Contaminated tape heads cause poor recording or sound drop-out in playback. We recommend cleaning after every 10 hours of operation.

Open the tape compartment and wipe the heads, the pinch rollers and the capstans with a cleaning swab slightly moistened with cleaning fluid or alcohol. Wipe the parts shown below:

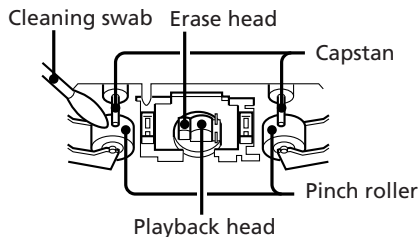

Insert a tape when the areas cleaned are completely dry.

To demagnetize the tape heads

After 20 to 30 hours of use, enough residual magnetism will have built up on the heads to begin to cause loss of high frequencies and hiss. At this time, demagnetize the heads and all metal parts in the tape path with a commercially available tape head demagnetizer. Refer to the instructions of the demagnetizer.

To clean the cabinet

Use a soft cloth slightly moistened with mild detergent solution.

To clean the CD

When a CD is dirty, clean it with a cleaning cloth. Wipe the CD from the center out.

Notes on CD

- Do not use solvents such as benzene, thinner, commercially available cleaners, or anti-static spray intended for vinyl LPs.
- If there is a scratch, dirt or fingerprints on the CD, it may cause a tracking error.

Specifications

Tuner CD player (HCD-T1)

Tuner section

Tuning range

FM: 87.5 – 108 MHz
AM: 531 – 1,710 kHz
(at 9 kHz interval)
530 – 1,710 kHz
(at 10 kHz interval)

Intermediate frequency

FM: 10.7 MHz
AM: 450 kHz

Antenna terminals

FM: 75 ohm unbalanced
AM: External antenna terminal

Timer Quarts lock system

Timer setting

One-minute step

Sleep timer

10-minute step, max. 90 minutes

CD player section

System Compact disc digital audio system

Laser Semiconductor laser
($\lambda = 780$ nm)

Laser output power

Less than 44.6 μ W*

* This output is the value measured at a distance of 200 mm from the objective lens surface on the optical pick-up block with 7 mm aperture.

Frequency response

2 Hz – 20 kHz ± 0.5 dB

Signal to noise ratio

More than 90 dB

Harmonic distortion

Less than 0.03%

Preamplifier section

Frequency response

15 Hz – 50 kHz $_{-3}^{+0}$ dB

Inputs

PC/MD IN:
Stereo phone jack, sensitivity
450 mV, impedance 47 kilohms

continue to next page →

→continued

Outputs DIGITAL OUT (CD OPTICAL OUT) jack:
Digital connector, -18 dBm, wavelength 660 nm
OUTPUT jack:
Stereo phone jack, 1 V, 1 kohm
PC/MD OUT jack:
Stereo phone jack, 250 mV, 1 kohm
PHONES (headphones) jack:
Stereo mini jack, accepts headphones of 8 ohms or more.

General

Power requirements
120 V AC, 60 Hz
Power consumption
25 W

Dimensions
Approx. 142 × 125 × 252 mm (w/h/d) (5⁵/₈ × 5 × 10 inches) incl. projecting parts and controls

Mass Approx. 3 kg (6 lb 10 oz)

Active speaker system (SA-N1)

Speaker system
Full range, bass reflex
Speaker units
10 cm dia., cone type

Rated impedance
4 ohms

Power requirements
120 V AC, 60 Hz

AUDIO POWER SPECIFICATIONS
POWER OUTPUT AND TOTAL HARMONIC DISTORTION:
With 4 ohm loads both channels driven, from 60-20,000 Hz; rated 10 watts per channel minimum RMS power, with no more than 0.9% total harmonic distortion from 10 watts to rated output.

Power consumption
27 W

Dimensions
Right: Approx. 125 × 200 × 215 mm (w/h/d) (5 × 7⁷/₈ × 8¹/₂ inches) incl. projecting parts and controls

Left: Approx. 125 × 200 × 200 mm (w/h/d) (5 × 7⁷/₈ × 7⁷/₈ inches) incl. projecting parts and controls

Mass Right: Approx. 2.9 kg (6 lb 7 oz)
Left: Approx. 1.7 kg (3 lb 12 oz)

Stereo cassette deck (TC-TX1)

Recording system
4-track 2-channel stereo
Frequency response
(DOLBY NR OFF)
50 - 15,000 Hz (±3 dB), using Sony TYPE IV cassette
50 - 14,000 Hz (±3 dB), using Sony TYPE II cassette
50 - 13,000 Hz (±3 dB), using Sony TYPE I cassette

Wow and flutter
±0.2% W.PEAK (DIN)
Dimensions
Approx. 142 × 125 × 205 mm (w/h/d) (5⁵/₈ × 5 × 8¹/₈ inches) incl. projecting parts and controls
Mass Approx. 2 kg (4 lb 7 oz)

Supplied accessories

- AM loop antenna (1)
- Sony RM-ST1 Remote (1)
- Sony SUM-3 (NS) batteries (2)
- FM lead antenna (1)
- Speaker cable (1)
- Audio cord (1)

Design and specifications are subject to change without notice.

Stereo cassette deck

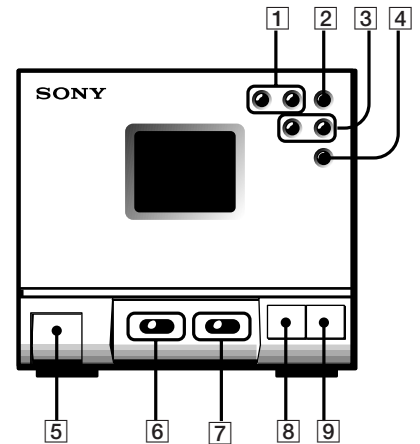

- 1 ► (front side play) and ◀ (reverse side play) buttons (12, 17)
- 2 ■ (stop) button (12)
- 3 AMS / ►► (fast rightward) and ◀◀ (fast leftward) buttons (12)
- 4 || (pause) button (12)
- 5 ▲ EJECT button (12, 18)
- 6 DOLBY NR OFF / ON switch (12)
- 7 DIRECTION ⇄ / ↻ switch (12)
- 8 ● REC button (13)
- 9 CD SYNC button (12)

Index to Parts and Controls

Refer to the pages indicated in parentheses for how to use the controls. Controls with an asterisk have indicators on themselves.

Front Panel

Tuner CD player

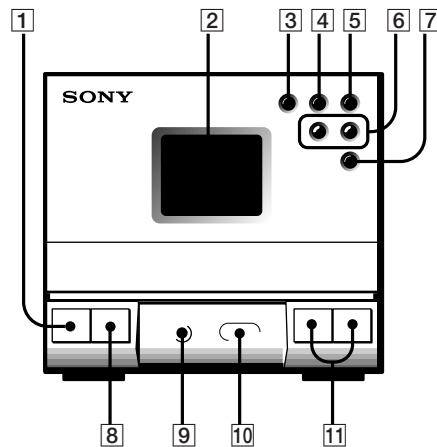

- 1 POWER switch (7)
- 2 Display window (6, 7, 17)
- 3 ►|| (play / pause) button (7)
- 4 ■ (stop) button (7, 13)
- 5 ▲ (open/close) button (7)
- 6 ◀◀◀ and ►►► (AMS / search) / TUNING + and - buttons (7, 10, 14)
- 7 BAND button (10)
- 8 FUNCTION button (13, 19)
- 9 PHONES jack (15)
- 10 Remote sensor
- 11 VOL + and - buttons (7, 11, 12)

Rear Panel

Tuner CD player

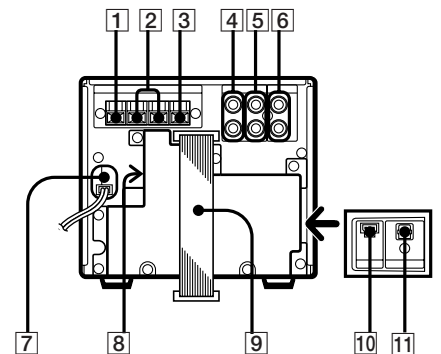

- 1 FM 75 Ω terminal (5, 19)
- 2 ⏚ (earth) terminal (5, 19)
- 3 AM terminal (5, 19)
- 4 PC/MD OUT jacks (19)
- 5 PC/MD IN jacks (19)
- 6 OUTPUT jacks (4)
- 7 AC power cord (5)
- 8 AC OUTLET connector (4)
- 9 SYSTEM CONTROL cable (4)
- 10 AU BUS (audio bus) connector (5)
- 11 DIGITAL OUT (CD OPTICAL OUT) jack (19)

Display Window

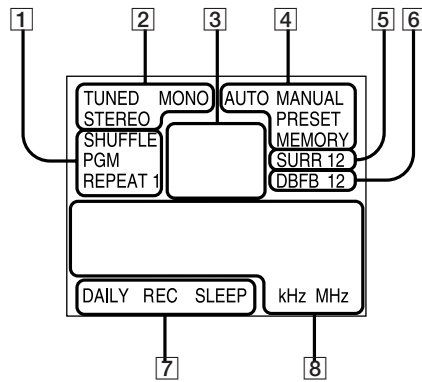

- 1 CD play mode indications (8, 9)
- 2 Tuner indications (10)
- 3 Track number/band indication (7, 10)
- 4 AUTO / MANUAL / PRESET / MEMORY indications (10, 11)
- 5 SURR (surround) indication (16)
- 6 DBFB indication (15)
- 7 DAILY / REC / SLEEP timer indications (17, 18)
- 8 Function / Time / frequency indication (6, 7, 10)

Remote (RM-ST1)

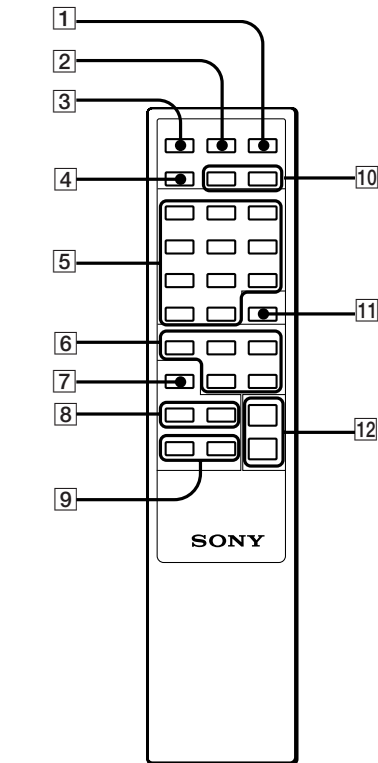

- 1 SYSTEM POWER switch (18)
- 2 SLEEP button (17)
- 3 TIMER SELECT button (17, 18)
- 4 TIMER SET button (17, 18)

- 5 CD and tuner operating buttons
 - ▶ (play) button (7)
 - ⏸ (pause) button (7)
 - (stop) button (7)
 - BAND button (10, 18)
 - TUNING + and - / ◀◀ and ▶▶ (AMS) buttons (7, 10)
 - STEREO / MONO button (10)
 - TUNING / PLAY MODE button (8, 10)
 - REPEAT button (9)
 - DISPLAY button (7)
 - MEMORY button (11)
- 6 Tape operating buttons
 - ◀ (reverse side play) and ▶ (front side play) buttons (12)
 - (stop) button (12)
 - ◀◀ (fast leftward) and ▶▶ (fast rightward) buttons (12)
- 7 FUNCTION button (13, 19)
- 8 Sound adjustment buttons
 - DBFB button (15)
 - SURROUND button (16)
- 9 BALANCE L and R buttons (15)
- 10 TIMER + and - buttons (6, 17, 18)
- 11 ENTER button (6, 18)
- 12 VOL + and - buttons (7, 11)

Index

- Antennas 5, 10, 19
- AMS 7, 12
- CD synchro-recording 12
- Clock setting 6
- Connecting
 - optional equipment 19
 - the system 4
- DBFB 15
- Inserting batteries 6
- Playing
 - a CD (normal play) 7
 - a tape 12
 - tracks in random order (shuffle play) 8
 - track in the desired order (program play) 8
 - tracks repeatedly (repeat play) 9
- Radio stations
 - presetting 11
 - tuning in 10
- Recording
 - a CD 12, 13, 14
 - a CD automatically 12
 - a CD manually 13
 - a radio program 13, 18
- Recording CDs
 - specifying track order 14
- Sound adjusting 15
- Timer
 - falling asleep to music 17
 - timer recording 18
 - waking up to music 17
- Tuner 10

