

# FM/AM Compact Disc Compact Player

## Operating Instructions

### About area code

The area code of the Discman you purchased is shown on upper left of the bar code label on the package.  
For accessories supplied with your Discman, check the area code of your model and refer to "Supplied accessories" toward the end of this manual.



D-T405

Sony Corporation ©1997 Printed in Malaysia

### Welcome!

Thank you for purchasing the Sony FM/AM Compact Disc Compact Player. Before operating your Discman, please read this manual and retain it for future reference.

### Owner's Record

The model and the serial numbers are located at the bottom. Record the serial number in the space provided below. Refer to them whenever you call upon your Sony dealer regarding this product.

Model No. D-T405 Serial No. \_\_\_\_\_

### WARNING

**To prevent fire or shock hazard, do not expose the unit to rain or moisture.**

**To avoid electrical shock, do not open the cabinet. Refer servicing to qualified personnel only.**

### CAUTION

The use of optical instruments with this product will increase eye hazard.

### INFORMATION

#### For the customers in the USA

This equipment has been tested and found to comply with the limits for a Class B digital device, pursuant to Part 15 of the FCC Rules. These limits are designed to provide reasonable protection against harmful interference in a residential installation. This equipment generates, uses, and can radiate radio frequency energy and, if not installed and used in accordance with the instructions, may cause harmful interference to radio communications. However, there is no guarantee that interference will not occur in a particular installation. If this equipment does cause harmful interference to radio or television reception, which can be determined by turning the equipment off and on, the user is encouraged to try to correct the interference by one or more of the following measures:

- Reorient or relocate the receiving antenna.
- Increase the separation between the equipment and receiver.
- Connect the equipment into an outlet on a circuit different from that to which the receiver is connected.
- Consult the dealer or an experienced radio/TV technician for help.

You are cautioned that any changes or modifications not expressly approved in this manual could void your authority to operate this equipment.

#### For the customers in Australia

The supply cord of the AC power adaptor cannot be replaced; if the cord is damaged, the AC power adaptor should be discarded.

#### For the customers not in Poland

The mark on the unit is valid only for products marketed in Poland.

#### For the customers not in Europe

The CE mark on the unit is valid only for products marketed in the European Union.

#### For the customers not in Russia

The mark on the unit and package is valid only for products marketed in Russia.

# Playing a CD right away!

If you want to play a CD right now, choose to use your Discman on house current. Other choices are the following three: rechargeable battery, dry batteries (see "Power Sources" on the reverse side) and car battery.

## 1 Connect

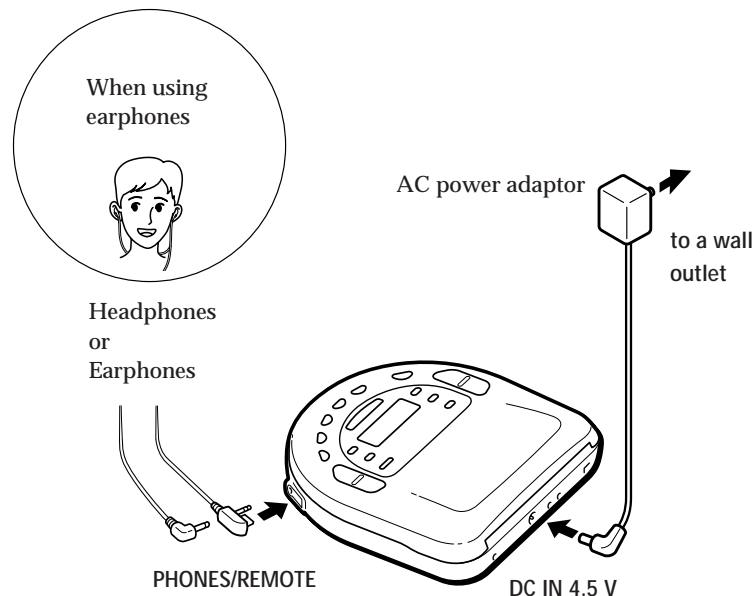

*For the models supplied with the AC plug adaptor*  
If the AC power adaptor does not fit the wall outlet, use the AC plug adaptor.

*For the models supplied with the remote control*

- Connect the microplug of the earphones to the remote control, not to the PHONES/REMOTE jack of the Discman.
- Connect the earphones to the remote control firmly. A loose connection may cause noise during playback.

*For the customers in the USA*  
U2 model supplied with headphones does not come supplied with a remote control.

## 2 Place a CD

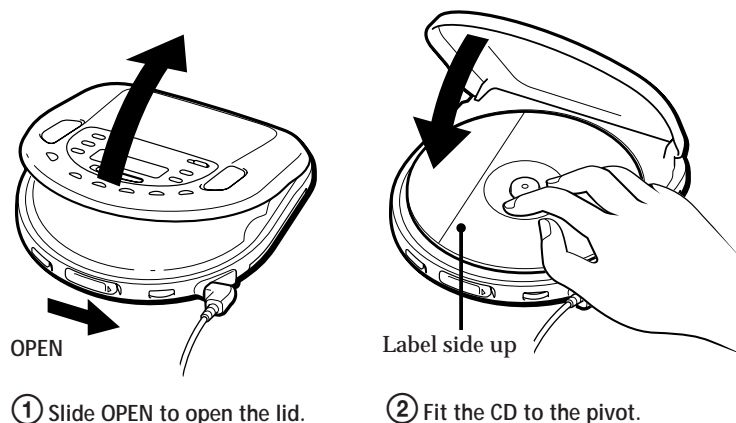

## 3 Play

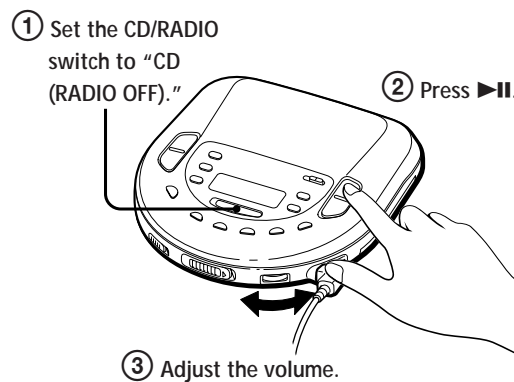

To stop play, press .

### Setting of the CD/RADIO switch

When listening to the CD



When listening to the radio (See "Radio operations" on the reverse side.)



To	Press
Pause (main unit only)	▶
Resume play after pause (main unit only)	▶
Find the beginning of the current track (AMS*)	◀◀ (◀◀ side of ▶ on the remote control) once**
Find the beginning of previous tracks (AMS)	◀◀ (◀◀ side of ▶) repeatedly**
Find the beginning of the next track (AMS)	▶▶ (▶▶ side of ▶) once**
Find the beginning of succeeding tracks (AMS)	▶▶ (▶▶ side of ▶) repeatedly**
Go forward quickly	Hold down ▶▶▶ (▶▶▶ side of ▶)**
Go backwards quickly	Hold down ◀◀◀ (◀◀◀ side of ▶)**

\*AMS = Automatic Music Sensor  
 \*\*These operations are possible during both play and pause.

**To remove the CD**  
 Remove the CD while pressing the pivot.

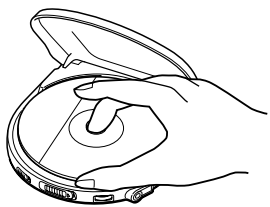

**Notes on controlling the volume with the remote control**  
 Set the VOL (volume) control on the remote control to MAX. Then adjust the volume on the Discman to the level that you want to be the maximum volume of the remote control.

**Notes on display**

- When you press ▶|| or ▶ (when RESUME is set to OFF), the total number of tracks in the CD and the total playing time appear for about 2 seconds.
- During play, the track number and the elapsed playing time of the current track appear.
- During pause, the elapsed playing time flashes in the display.
- Between tracks, the time to the beginning of the next track will appear with the "-" indication.

**Notes on handling CDs**

- To keep the CD clean, handle it by its edge. Do not touch the surface.
- Do not stick paper or tape onto the CD.
- Do not expose the CD to direct sunlight or heat sources such as hot air ducts. Do not leave the CD in a car parked under direct sunlight.

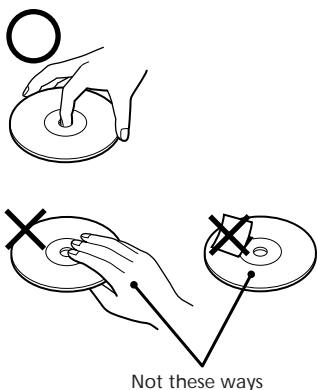

## ▶ Other CD Operations

### Playing tracks repeatedly (Repeat Play)

You can play tracks repeatedly in normal, INTRO PGM, shuffle or RMS (Random Music Sensor) play modes. Repeat all the tracks or only one track.

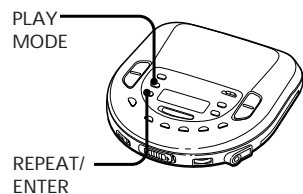

**To repeat all the tracks**  
 Press REPEAT/ENTER during play. The "↺" indication appears.

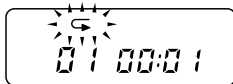

To cancel repeat play, press REPEAT/ENTER again.

**To repeat a single track**  
 1 Press REPEAT/ENTER while the track you want to repeat is playing. The "↺" indication appears.

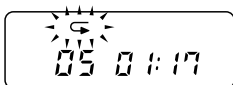

2 Press PLAY MODE repeatedly until "1" appears.

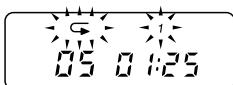

To repeat another track, press ◀◀ or ▶▶.

To cancel repeat play, press REPEAT/ENTER again.

### Playing only the tracks you want (INTRO PGM Play)

You can choose and play your favorite tracks by scanning through the beginning of each track in a CD.

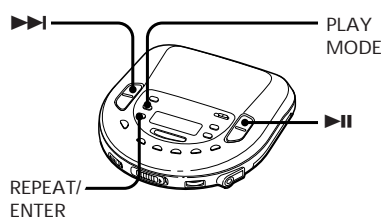

1 During play, press PLAY MODE repeatedly until "INTRO PGM" flashes.

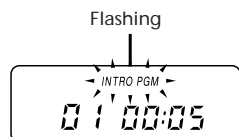

2 Press ▶|| to start scanning. The Discman plays about the first 15 seconds of each track and "INTRO PGM" flashes faster.

3 Press REPEAT/ENTER while the track you want is playing. To skip the track, press ▶▶ or just wait for the next track.

After you have gone through the CD, "INTRO PGM" stops flashing and the tracks you have chosen play automatically.

To finish programming before going through the whole CD, press ▶||. The selected tracks will be played.

To cancel INTRO PGM play, press PLAY MODE repeatedly until the play mode indication disappears from the display.

### Playing tracks in random order (Shuffle Play)

You can play the tracks in a CD in random order.

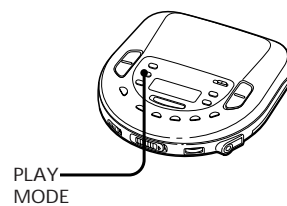

During play, press PLAY MODE repeatedly until "SHUF" appears. The tracks play in random order.

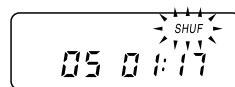

To cancel shuffle play, press PLAY MODE repeatedly until the play mode indication disappears from the display.

**Note**  
 • During shuffle play, you cannot return to previous tracks by pressing ◀◀.

### Playing tracks in the order you want (RMS play)

You can program up to 22 tracks to play in any order you choose.

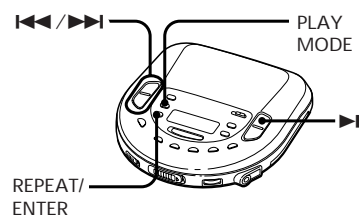

1 During play, press PLAY MODE repeatedly until "RMS" flashes.

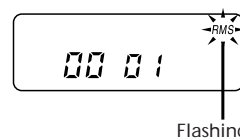

2 Press ◀◀ or ▶▶ to choose a track. The track number and the playing order appear.

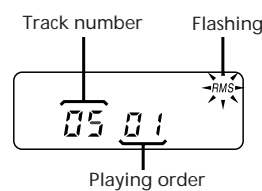

3 Press REPEAT/ENTER to program the track.

4 Repeat steps 2 and 3 to program the remaining tracks.

5 Press ▶||. "RMS" stops flashing and the tracks you have chosen play in the order you specified.

To cancel RMS play, press PLAY MODE until "RMS" disappears.

#### To check the program

During programming:  
 Press REPEAT/ENTER before step 5.  
 During RMS play:  
 Press PLAY MODE repeatedly until "RMS" flashes, then press REPEAT/ENTER. Each time you press REPEAT/ENTER, the track number and the playing order appear in the order you specified.

**Note**  
 • If you program another track after the 22nd track, the first track programmed is cleared and the new track is programmed instead.

## Using other functions

**To enjoy more powerful bass sound**  
 You can enjoy a powerful bass-boosted sound.

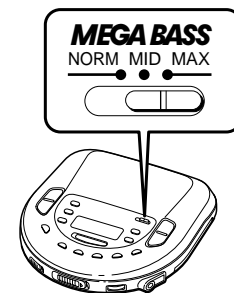

Set MEGA BASS to the desired position.

**Note**  
 • If the sound is distorted when emphasizing bass, turn down the volume.

### To prevent sound from skipping (ESP)

The ESP (Electronic Shock Protection) function prevents the sound from skipping by using a buffer memory that stores music data for about 10 seconds. Use this function when listening in a car or during a walk.

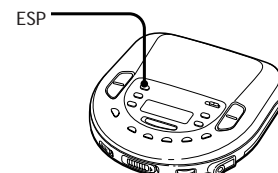

Press ESP. The ESP indication appears.

To release the ESP function, press ESP again.

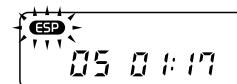

**Notes**

- Playing may stop when the Discman gets a strong shock even with the ESP function on.
- You may hear a noise or sound skip when:
  - listening to a dirty or scratched CD,
  - listening to an audio test CD or,
  - the Discman receives continuous shock during play.
- When you use an optical digital connecting cord, the ESP function will be disabled.

### To lock the buttons

You can lock your Discman against any accidental operations. You can still operate the unit with the earphones with remote control.

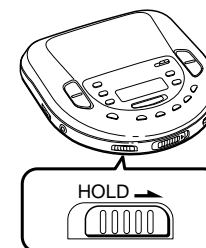

Slide HOLD in the direction of the arrow. When you press any button, "Hold" appears in the display and you cannot operate the unit.

To unlock, slide HOLD back.

### To protect your hearing (AVLS)

The AVLS (Automatic Volume Limiter System) function keeps down the maximum volume to protect your ears.

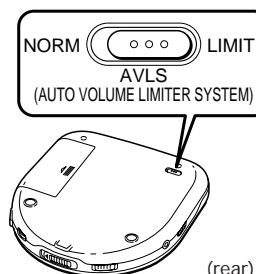

Set AVLS to LIMIT. The AVLS indication appears.



**Note**  
 • If the sound is distorted when you listen to the bass-boosted sound with the AVLS function, turn down the volume.

### To resume playing from the point you stopped the CD (Resume Play)

Normally, every time you stop and play, playing starts from the beginning of the CD. The resume play function, however, let you listen to from the point at which you last turned off the Discman.

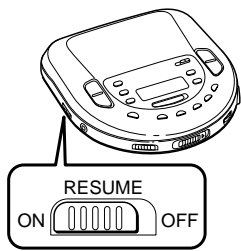

Set RESUME to ON.

To cancel resume play, set RESUME to OFF.

#### Notes

- Even if RESUME is set to ON, playing starts from the beginning when you open the lid.
- The resume point may be inaccurate by about 30 seconds.

### To turn off the beep

You can turn off the beep that sounds as you operate your Discman. (You cannot turn off the beep that sounds during the radio operation.)

Disconnect the power source (AC power adaptor, rechargeable battery or alkaline batteries). While you press and hold down ■, connect the power source again. To make the beep sound again, disconnect the power source, and then connect it without pressing ■.

## Connecting to other stereo equipment

You can listen to the CD through other stereo equipment or record a CD on a cassette tape or a MiniDisc. Refer to the instruction manual of the other equipment for details. Before making connections, turn off each piece of equipment.

### Using the connecting cord

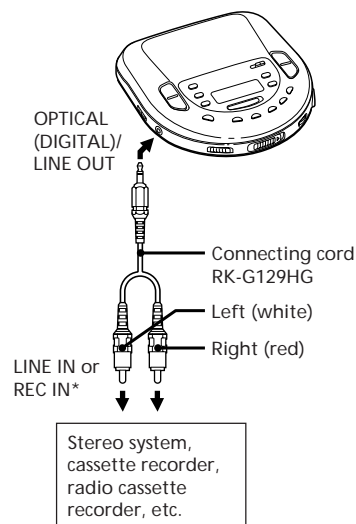

### Using the optical digital connecting cord

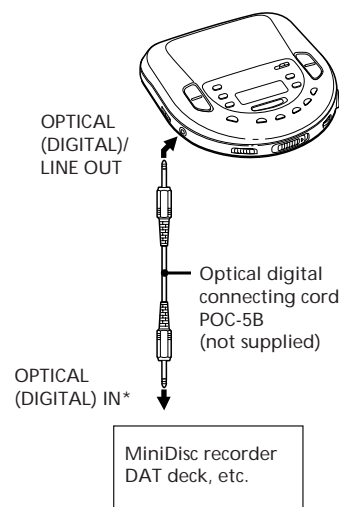

\*If the OPTICAL (DIGITAL) IN jack is square-shaped, use the POC-5AB optical digital connecting cord instead.

#### Notes on connecting to other stereo equipment

- Before you play the CD, turn down the volume of the connected equipment so as not to damage the connected speakers.
- The beep sound is not output from the OPTICAL (DIGITAL)/LINE OUT jack.
- When you connect other equipment to the OPTICAL (DIGITAL)/LINE OUT jack, you cannot adjust the volume by this unit.
- When you record a CD on a cassette tape using a tape recorder that has the blank search function, release the ESP function. If the ESP function is on, the blank search function does not work.

### Recording with optical digital connection

Record a CD on a MiniDisc, DAT, etc., according to the following procedure.

- 1 Press ►|| on the Discman to start play.
- 2 Press ►|| again to pause.
- 3 Press ◀◀/▶▶ to select the track you want to record.
- 4 Press ● (record) on the MiniDisc recorder, DAT recorder, etc.
- 5 Press ►|| on the Discman to release pause.

#### Notes

- Connect the optical digital connecting cord while the Discman is in stop mode. If you make connection just after stopping the Discman, optical signals may not be output.
- If you record without pausing the Discman, some CD may have problem with recording the first track number correctly.
- When you use digital equipment with your Discman, use the AC power adaptor. If you use a rechargeable battery or alkaline batteries, the optical digital signal will not be output from the Discman. (Unexpected phenomena may occur, for instance, you cannot record a CD on connected equipment.)
- MEGA BASS can be output from the PHONES/REMOTE jack, but not from the OPTICAL (DIGITAL)/LINE OUT jack.
- When you use an optical digital connecting cord, the ESP function will be disabled.

Continue to the reverse side →

## Playing a CD in a car

You can use your Discman in a car as illustrated below.

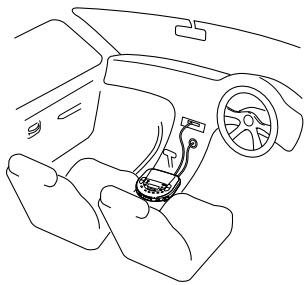

To connect your Discman to a car cassette deck, you need the following accessories:

- Car connecting pack CPA-9
  - Car battery cord DCC-E245
- or,
- Mount kit CPM-300PC (Mount plate + Car connecting pack + Car battery cord)

- or,
- Car battery cord with car connecting pack DCC-E26CP

Refer to the instruction manual of each accessory for details.

**When you use the CPM-300PC mount kit/CPM-300P mount plate**  
Attach the car mount adaptor supplied to the CPM-300PC/300P before installing the Discman.

### Notes

- Do not put the Discman on the dashboard.
- Do not leave the Discman in a car parked under sunlight.
- Use a Sony car connecting pack for reducing noise.

### Switched ignition function

With this feature, your Discman stops automatically when you turn off the engine of the car. (This function is not possible with some cars depending on the model).

## Using the remote control

### For the customers supplied with the remote control

You can use the remote control as the wired remote control.

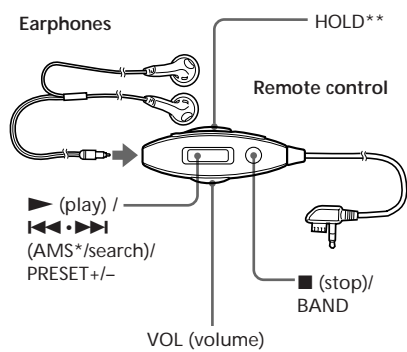

\* Automatic Music Sensor

\*\*When you are not using the remote control, slide HOLD in the direction of the arrow. To unlock, slide HOLD back.

### Note

- Use only the supplied remote control. You cannot operate this unit with the remote control supplied with other models.

## Radio operations

### Listening to the radio

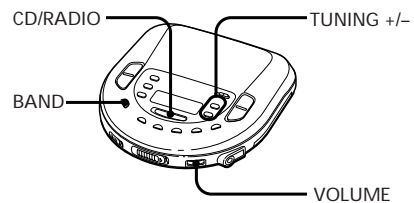

1 Set the CD/RADIO switch to "RADIO."

2 Press BAND until the band you want appears. Each time you press the button, the display changes: FM1 → FM2 → FM3 → FM4 → FM5 → AM.

3 Press TUNING +/- to tune in the station you want and adjust the volume.

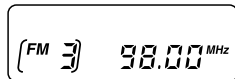

### To turn off the radio

Set the CD/RADIO switch to "CD (RADIO OFF)."

### Notes

- When you do not listen to the radio, set the CD/RADIO switch to "CD (RADIO OFF)" to save the battery power.
- You cannot turn on/off the radio nor tune in the station using the remote control. Use the remote control when listening to the preset radio stations.

### To tune in the station quickly

Hold down TUNING +/- in step 3 until the frequency digits begin to change in the display. The Discman automatically scans the radio frequencies and stops when it finds a clear station.

### To improve broadcast reception

For FM, extend the headphones/earphones cord.



For AM, reorient the Discman itself.



### Note

- Keep the headphones/earphones connected to the PHONES/REMOTE jack of the player even when listening to the FM program through the speakers connected to the LINE OUT jack of the player. The headphones/earphones cord works as the FM antenna.

### When listening to the radio on dry batteries or rechargeable battery

If you connect the external power source plug to the DC IN 4.5 V jack of your Discman, the radio station will change to the initial one (default). Tune in the station again to continue listening to it.

## Presetting radio stations

You can store radio stations into the Discman's memory. You can preset up to 30 stations, 5 for each band (FM1, FM2, FM3, FM4, FM5 and AM) in any order. Once you've preset the stations, press one of the 1 - 5 buttons to tune in your favorite stations.

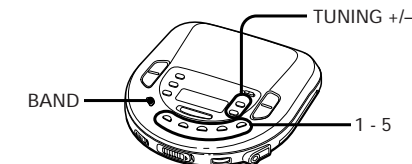

1 Tune in the station you want.

2 Hold down one of the 1 - 5 buttons that you want to preset the new station on for more than 2 seconds. When the station is preset successfully, the beep sounds and the indications "PRESET" and appear in the display. The new station replaces the old one.

FM:

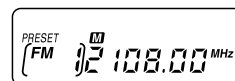

AM:

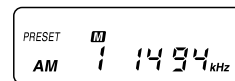

## Playing preset radio stations



1 Press BAND (BAND on the remote control) to select the band.

2 Press the number button (PRESET +/- on the remote control) to tune in a stored station.

## Power Sources

### Using rechargeable battery

Charge the rechargeable battery before using it for the first time.

You can use either BP-DM10 or BP-DM20 rechargeable battery for this unit. You can use them in the same way, but their charging time and battery life are different. Check the model number of your rechargeable battery, and use it.

1 Set the CD/RADIO switch to "CD (RADIO OFF)."

2 Open the lid of the battery compartment.

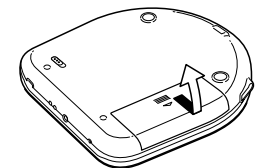

(rear)

3 Insert the rechargeable battery so that the word "SONY" is facing the same direction as illustrated inside the lid, and close the lid.

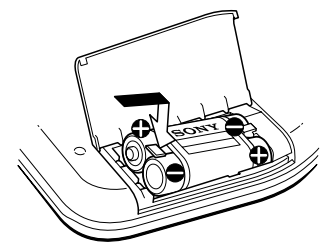

4 Connect the AC power adaptor. The indications "CHG" and light up. Charge for about 2 hours (for BP-DM10) or 3 hours (for BP-DM20).

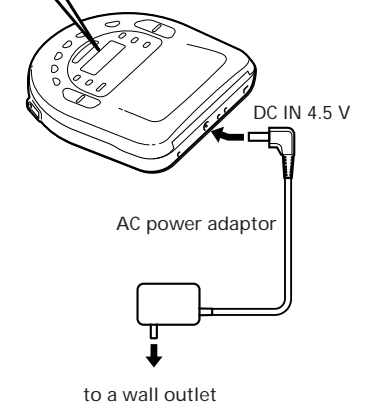
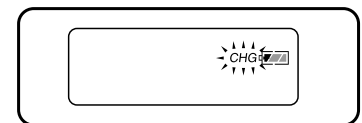

5 When fully charged, "CHG" and disappear. Disconnect the AC power adaptor.

### When to charge the battery

When the battery becomes weak, indication appears in the display. If the battery is used up, "Lo bātt" appears in the display. Charge the rechargeable battery. To keep the original battery capacity for a long time, recharge the battery when the battery is used up (discharged).

### Notes

- Charging time varies depending on how the rechargeable battery is used.
- If the battery is new or has not been used for a long time, it may not be charged completely until you charge and discharge it several times.
- If the battery life becomes shorter by about half, replace it with Sony BP-DM10 or BP-DM20 rechargeable battery. Do not use any other rechargeable battery (R6 type rechargeable battery, etc.).

## Using dry batteries

- 1 Open the lid of the battery compartment.

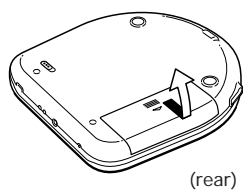

- 2 Insert two LR6 (size AA) alkaline batteries by matching the ⊕ and ⊖ to the diagram inside the battery compartment and close the lid.

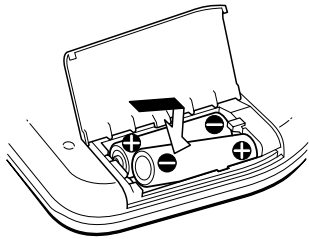

### When to replace the dry batteries

When the batteries become weak, indication appears in the display. If the batteries are used up, "Lo bā++" appears in the display. Replace all the batteries with new ones.

### Notes

- Do not charge the dry batteries.
- Do not mix new batteries with old ones.
- Do not use different types of batteries together.
- Do not use manganese batteries for this unit.
- When the batteries are not to be used for a long time, remove them.

## Using the battery case

You can use the unit for longer time by using the battery case, in addition to the rechargeable battery or batteries in the battery compartment of the unit. Batteries in the battery case and the rechargeable battery or batteries in the battery compartment are consumed together.

- 1 Hook the battery case onto the Discman and fasten the screw.

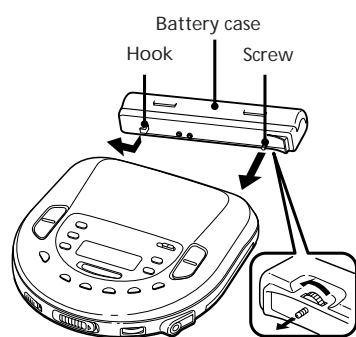

- 2 Open the lid of the battery case.

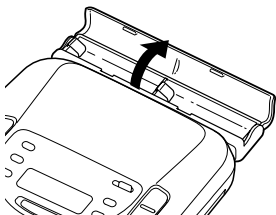

- 3 Insert two LR6 (size AA) alkaline batteries by matching the ⊕ and ⊖ to the diagram inside the battery case and close the lid.

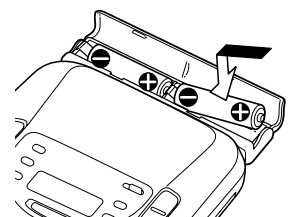

### Battery life (approx. hours)

When using	ESP function		Radio on
	off	on	
BP-DM20 (charged for about 3 hours*)	8	7	13
Two alkaline batteries	15	9.5	25
BP-DM10 (charged for about 2 hours*)	3.5	3	6.5
BP-DM20 + Battery case (two alkaline batteries)	24	20	38
Two alkaline batteries + Battery case (two alkaline batteries)	33	22	60
BP-DM10 + Battery case (two alkaline batteries)	20	15	32

(When the unit is used on a flat and stable place)

\*Charging time varies depending on how the rechargeable battery is used.

## Additional Information

### Precautions

#### On safety

- Should any solid objects or liquid fall into the unit, unplug it and have it checked by qualified personnel before operating it any further.
- Do not put any foreign objects in the DC IN 4.5 V (external power input) jack.

#### On power sources

- When you are not using the unit for a long time, disconnect all power sources from the unit.
- The nameplate indicating operating voltage, power consumption, etc. is located at the bottom of the AC power adaptor (for EA3 only.)

#### On the AC power adaptor

- Use only the supplied AC power adaptor. If your unit is not supplied with it, use AC-E45HG AC power adaptor. Do not use any other AC power adaptor.

Polarity of the plug



- To unplug the AC power adaptor from the wall outlet, grasp the adaptor itself, do not pull its cord.

#### On dry and rechargeable batteries

- Do not throw the batteries into fire.
- Do not carry the rechargeable battery with coins or other metallic objects. It can generate heat if the positive and negative terminals of the battery are accidentally contacted by a metallic object.

#### On the unit

- Keep the lens on the unit clean and do not touch it. If you do so, the lens may be damaged and the unit will not operate properly.
- Do not put any heavy object on top of the unit. The unit and the CD may be damaged.
- Do not leave the unit in a location near heat sources, or in a place subject to direct sunlight, excessive dust or sand, moisture, rain, mechanical shock, unlevelled surface, or in a car with its windows closed.
- If the unit causes interference to the radio or television reception, turn off the unit or move it away from the radio or television.
- Do not wrap the unit in a cloth or blanket during use as it may cause malfunction or serious accidents.

#### On headphones/earphones

##### Road safety

Do not use headphones/earphones while driving, cycling, or operating any motorized vehicle. It may create a traffic hazard and is illegal in some areas. It can also be potentially dangerous to play your headsets at high volume while walking, especially at pedestrian crossings. You should exercise extreme caution or discontinue use in potentially hazardous situations.

##### Preventing hearing damage

Avoid using headphones/earphones at high volume. Hearing experts advise against continuous, loud and extended play. If you experience a ringing in your ears, reduce volume or discontinue use.

##### Caring for others

Keep the volume at a moderate level. This will allow you to hear outside sounds and to be considerate to the people around you.

## Maintenance

### To clean the lens

Clean the lens with a lens cleaning kit KK-DM1.

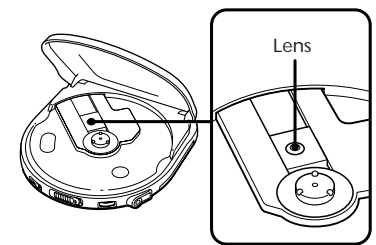

### To clean the casing

Use a soft cloth slightly moistened in water or a mild detergent solution. Do not use alcohol, benzene or thinner.

## Troubleshooting

Should any problem persist after you have made these checks, consult your nearest Sony dealer.

### The CD does not play or "no d1 5C" appears in the display though a CD is placed in the unit.

- The CD is dirty or defective.
- Insert the CD with the label side up.
- Moisture condensation has occurred. Leave the unit aside for several hours until the moisture evaporates.
- The lens is dirty.
- Close the lid of the unit and the battery compartment firmly.
- Make sure the batteries are inserted correctly.
- Connect the AC power adaptor to a wall outlet securely.

### When you press ►II, "00" appears in the display for a moment, and disappears. The CD does not play.

- Rechargeable battery or dry batteries are used up. Charge the rechargeable battery or replace dry batteries with new ones.

### No sound, or noise is heard.

- Connect the plugs firmly.
- Plugs are dirty. Clean the plugs with a dry soft cloth periodically.

### "Hi dc 1 n" appears in the display.

- Use only the supplied AC power adaptor or recommended AC power adaptor AC-E45HG (not supplied).

### "Hol d" appears in the display when you press a button.

- The buttons are locked. Slide HOLD back.

### "Lo bā++" appears in the display when you press a button.

- The rechargeable battery is used up completely. Connect the AC power adaptor and charge the battery.
- The dry batteries are used up. Replace them with new ones.

### The battery life is short.

- Manganese batteries are used. Use alkaline batteries.
- Replace the batteries with new ones.

### The volume is limited to a certain level even if you attempt to turn it up.

- AVLS selector is set to LIMIT. Set it to NORM.

### During recording with optical digital connection, the truck number cannot be recorded correctly.

- Record the truck number again using the MiniDisc recorder, DAT recorder, etc.
- Record again according to the procedure shown in the section "Connecting to other stereo equipment."

### When listening to the radio, the audio is weak or has poor quality.

- Replace the batteries with new ones.
- Move the unit away from the TV.

## Specifications

### CD player section

#### System

Compact disc digital audio system

#### Laser diode properties

Material: GaAlAs

Wavelength:  $\lambda = 780$  nm

Emission duration: Continuous

Laser output: Less than 44.6  $\mu$ W (measured at 200 mm away from the objective lens surface)

#### Error correction

Sony Super Strategy Cross Interleave Reed Solomon Code

#### D-A conversion

1-bit quartz time-axis control

#### Frequency response

20 - 20,000 Hz  $\pm 1$  dB (measured by EIAJ CP-307)

#### Output (at 4.5 V input level)

Headphones (stereo minijack)

15 mW + 15 mW at 16 ohms

Line output (stereo minijack)

Output level 0.7 V rms at 50 kilohms

Recommended load impedance over 10 kilohms

Optical digital output (optical output connector)

Output level: -21 - -15 dBm

Wavelength: 630 - 690 nm at peak level

### Radio section

#### Frequency range

FM: 87.5 - 108.0 MHz

AM 531 - 1,602 kHz

#### Antenna

FM: Headphones cord antenna

AM: Built-in ferrite bar antenna

### General

For the area code of the model you purchased, check the upper left side of the bar code on the package.

#### Power requirements

- Sony BP-DM10 Rechargeable battery: 2.4 V DC, Ni-Cd, 650 mAh
- Sony BP-DM20 Rechargeable battery: 2.4 V DC, Ni-MH, 1,200 mAh
- Two LR6 (size AA) batteries: 3 V DC
- AC power adaptor (DC IN 4.5 V jack):  
U2/CA2/E92 model: 120 V, 60 Hz  
CED/CEF/E13/CN2 model: 220 - 230 V, 50/60 Hz  
CEK model: 230 - 240 V, 50 Hz  
EA3 model: 110 - 240 V, 50/60 Hz  
AU2 model: 240 V, 50 Hz  
JE.W/E33 model: 100 - 240 V, 50/60 Hz
- Sony CPM-300P mount plate for use on car battery: 4.5 V DC

#### Dimensions (w/h/d) (without projecting parts and controls)

Approx. 132 × 34.0 × 135.6 mm  
(5  $\frac{1}{4}$  × 1  $\frac{3}{8}$  × 5  $\frac{3}{8}$  in.)

#### Mass (without rechargeable battery)

Approx. 280 g (9.9 oz)

#### Operating temperature

5°C - 35°C (41°F - 95°F)

### Supplied accessories

For the area code of the model you purchased, check the upper left side of the bar code on the package.

- AC power adaptor (1)
  - Headphones (1)<sup>a)</sup>
  - Earphones with remote control (1)<sup>b)</sup>
  - Rechargeable battery (1)
  - Battery case (1)<sup>c)</sup>
  - Connecting cord (Phono plug × 2 ↔ stereo miniplug) (1)<sup>d)</sup>
  - Carrying case (1)
- a) Supplied with U2 model  
b) Not supplied with U2 model  
c) Not supplied with U2, CA2 and E92 models  
d) Not supplied with JE.W, CED, CEK and CEF models

Design and specifications are subject to change without notice.

### Recommended accessories

Mount plate CPM-300P  
Mount kit CPM-450PC\*  
Mount kit CPM-300PC  
Car connecting pack CPA-9  
Car battery cord with car connecting pack DCC-E26CP  
Car battery cord DCC-E245  
Active speaker system SRS-A21, SRS-A41, SRS-A71  
Rechargeable battery BP-DM10, BP-DM20  
Connecting cord RK-G129HG  
Optical digital connecting cord POC-5B, POC-10B, POC-15B, POC-5AB, POC-10AB, POC-15AB  
AC power adaptor AC-E45HG  
Stereo headphones MDR-35, MDR-E848  
\*Sold in Japan only

Your dealer may not handle some of the above listed accessories. Please ask the dealer for detailed information about the accessories in your country.