

# *Mini Hi-Fi Component System*

---

## Operating Instructions

### Owner's Record

The model and serial numbers are located on the rear panel. Record the serial number in the space provided below. Refer to them whenever you call upon your Sony dealer regarding this product.

Model No.

Serial No.



## *DHC-MD313*

## WARNING

To prevent fire or shock hazard, do not expose the unit to rain or moisture.

To avoid electrical shock, do not open the cabinet. Refer servicing to qualified personnel only.

Do not install the appliance in a confined space, such as a bookcase or built-in cabinet.

US and foreign patents licensed from Dolby Laboratories Licensing Corporation.

The laser component in this product is capable of emitting radiation exceeding the limit for Class 1.

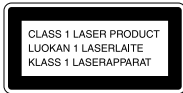

This appliance is classified as a CLASS 1 LASER product. The CLASS 1 LASER PRODUCT MARKING is located on the rear exterior.

This caution label is located inside the unit.



## NOTICE FOR THE CUSTOMERS IN CANADA

### CAUTION:

TO PREVENT ELECTRIC SHOCK, DO NOT USE THIS POLARIZED AC PLUG WITH AN EXTENSION CORD, RECEPTACLE OR OTHER OUTLET UNLESS THE BLADES CAN BE FULLY INSERTED TO PREVENT BLADE EXPOSURE.

---

# Table of Contents

---

## Getting Started

|   |   |
|---|---|
| Step 1: Hooking up the system .....                             | 4 |
| Step 2: Setting the time .....                                  | 6 |
| Step 3: Presetting radio stations .....                         | 7 |
| Connecting optional A/V components<br>and outdoor aerials ..... | 9 |

## Basic Operations

|                                |    |
|--------------------------------|----|
| Playing a CD .....             | 11 |
| Recording a CD on an MD .....  | 12 |
| Playing an MD .....            | 14 |
| Listening to the radio .....   | 15 |
| Recording from the radio ..... | 17 |

---

## The CD Player

|  |    |
|--|----|
| Playing the CD tracks repeatedly .....         | 18 |
| Playing the CD tracks in random<br>order ..... | 19 |
| Programming CD tracks .....                    | 19 |
| Using the CD display .....                     | 21 |
| Looping part of a CD track .....               | 21 |
| Labelling a CD .....                           | 22 |

---

## The MD Deck

|  |    |
|--|----|
| <b>- Playback</b>  |    |
| Playing the MD tracks repeatedly .....                             | 24 |
| Playing the MD tracks<br>in random order .....                     | 24 |
| Programming the MD tracks .....                                    | 25 |
| Using the MD display .....   | 26 |
| <b>- Recording</b>   |    |
| Before you start recording .....                                   | 28 |
| Recording the favorite CD tracks<br>on an MD .....                 | 29 |
| Recording on an MD manually .....                                  | 30 |
| Starting recording with 6 seconds of<br>prestored audio data ..... | 31 |
| Marking track numbers .....  | 33 |

|   |    |
|---|----|
| Making a space between tracks 3<br>seconds long ..... | 34 |
| <b>- Editing</b>                                      |    |
| Before you start editing.....                         | 36 |
| Labelling an MD .....                                 | 37 |
| Erasing recordings .....                              | 38 |
| Moving recorded tracks .....                          | 40 |
| Dividing recorded tracks .....                        | 41 |
| Combining recorded tracks .....                       | 42 |
| Undoing the last edit .....                           | 43 |

---

## Sound Adjustment

|  |    |
|--|----|
| Adjusting the sound .....              | 44 |
| Selecting the Preset Equalizer menu .. | 45 |

---

## Other Features

|  |    |
|--|----|
| Labelling the preset stations .....                              | 45 |
| Using the Radio Data System (RDS)<br>(European model only) ..... | 47 |
| Falling asleep to music .....                                    | 47 |
| Waking up to music .....   | 48 |
| Timer recording radio programmes ..                              | 49 |

---

## Additional Information

|                                 |            |
|---------------------------------|------------|
| Precautions .....               | 51         |
| System limitations of MDs ..... | 52         |
| Self-diagnosis Display .....    | 53         |
| Troubleshooting .....           | 53         |
| Specifications .....            | 56         |
| Index .....                     | Back cover |

## Step 1: Hooking up the system

Perform the following procedure **1** to **4** to hook up your system using the supplied cords and accessories. To complete the setup, do steps 2 and 3 also.

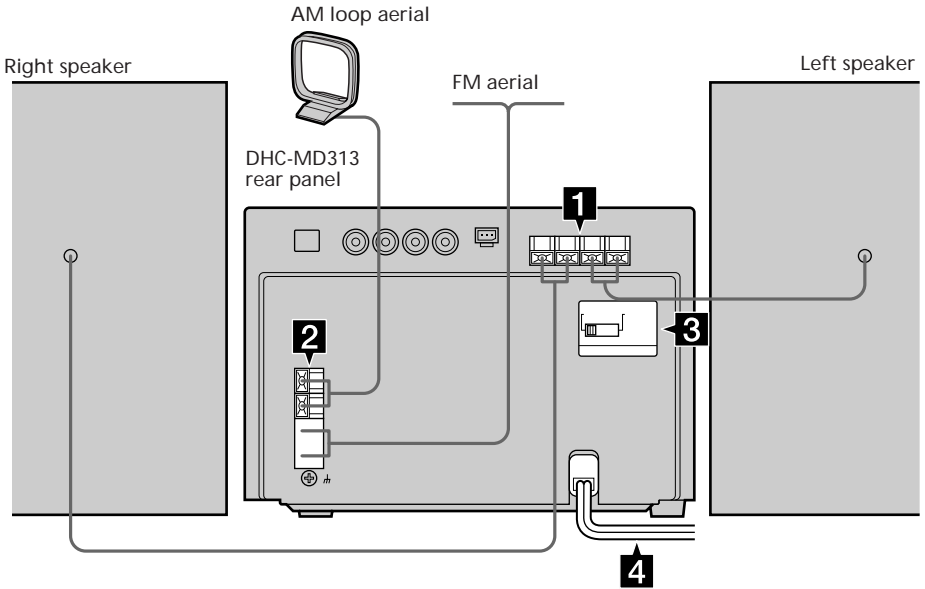

### 1 Connect the speakers.

Connect the speaker cords to SPEAKER terminals of the same colour. Keep the speaker cords away from the aerials to prevent noise.

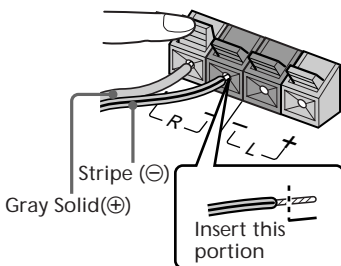

### 2 Connect the FM/AM aerials.

Set up the AM loop aerial, then connect it.

#### European model

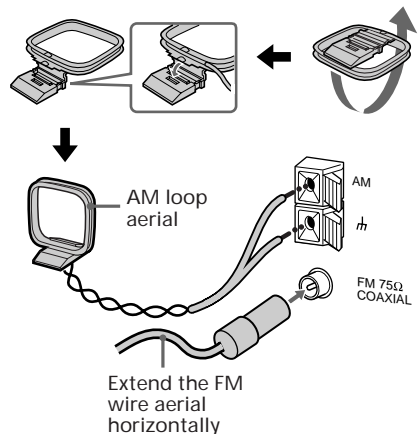

## Other models

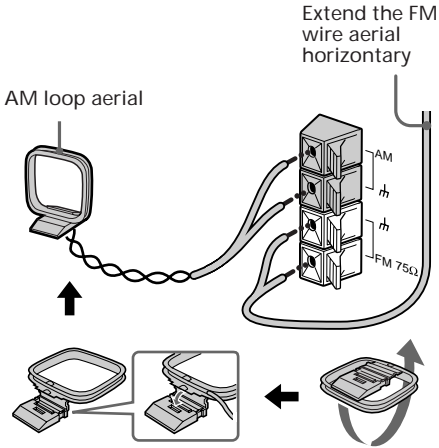

- 3 Set **VOLTAGE SELECTOR** to the position of your local power line voltage (except for North American and European model).

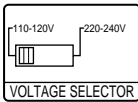

- 4 Connect the mains lead to a wall outlet.

If the plug of the mains lead does not fit your wall outlet, detach the supplied adaptor from the plug (except for North American and European model).

## Inserting two R6 (size AA) batteries into the remote

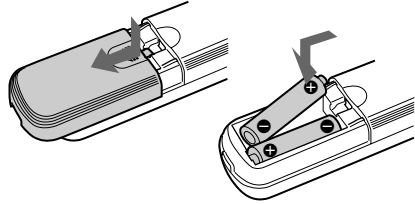

### Tip

With normal use, the batteries should last for about six months. When the remote no longer operates the system, replace both batteries with new ones.

### Notes on the batteries

- If you do not use the remote for a long period of time, remove the batteries to avoid possible damage from battery leakage.
- Be sure to insert the batteries in correct direction.
- Do not mix new batteries with old ones.
- Do not use different types of batteries together.
- Do not use the battery that is leaking.
- If the battery leaks, clean the battery compartment and replace all the batteries with new ones.

## Step 2: Setting the time

You can set the time, when you turn off the system power. You must set the time before you can use the timer functions.

The clock is on a 24-hour system for the European model, and a 12-hour system for other models.

The European model is used for illustration purpose.

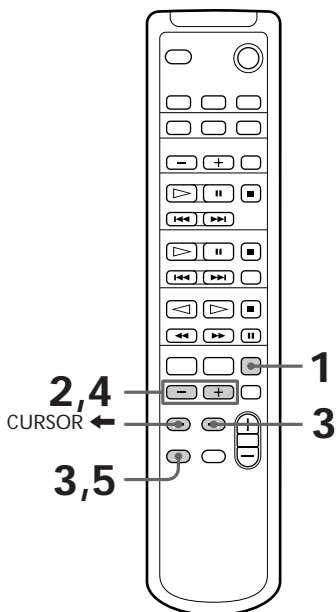

**1** Press CLOCK/TIMER SET.  
The clock appears and the hour indication flashes.

**2** Press +/- to set the hour.



**3** Press ENTER/YES or CURSOR →.  
The minute indication flashes.

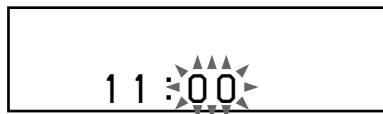

**4** Press +/- to set the minute.

**5** Press ENTER/YES.  
The clock starts.

### If you have made a mistake

Press CURSOR ← or → repeatedly so that the incorrect item flashes, then set it again.

### To change the preset time

When you turn off the system power, you can change the preset time.

- 1 Press CLOCK/TIMER SET.
- 2 Press +/- repeatedly until "CLOCK SET?" appears.
- 3 Press ENTER/YES.
- 4 Repeat steps 2 through 5.

### Tips

- The built-in clock shows the time in the display while the power is off.
- The upper dot flashes for the first half of a minute (0 to 29 seconds), and the lower dot flashes for the last half of a minute (30 to 59 seconds).

# Step 3: Presetting radio stations

You can preset the following number of stations:

- North American model : 20 for FM and 10 for AM
- European model: 20 for FM, 10 for MW, and 10 for LW
- Other models: 20 for FM, 10 for MW, and 10 for SW

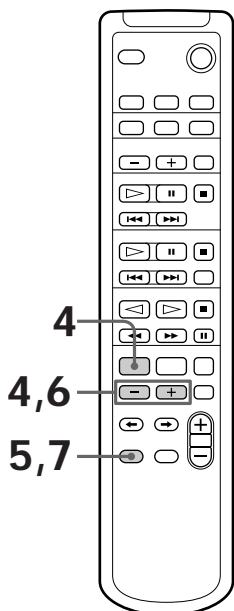
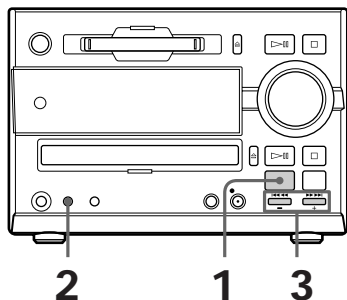

## Step 1: To tune in the desired preset the station

- 1 Press TUNER/BAND repeatedly until the band you want appears in the display.  
When press TUNER/BAND turns the power on.  
Each time you press the button, the band changes as follows:  
North American model:  
FM → AM  
European model:  
FM → MW → LW  
Other models:  
FM → MW → SW

- 2 Press TUNING MODE repeatedly until "AUTO" appears.



- 3 Press TUNING +/-.  
The frequency indication changes and scanning stops when the system tunes in a station. "TUNED" and "STEREO" (for a stereo programme) appear. When you want to stop scanning, press TUNER/BAND.

## Step 2: To preset the station

- 4 Press EDIT then +/- on the remote repeatedly until "Frq-Memory?" appears.



### Step 3: Presetting radio stations (continued)

---

**5** Press ENTER/YES on the remote.

---

**6** Press +/- on the remote to select the preset number you want.

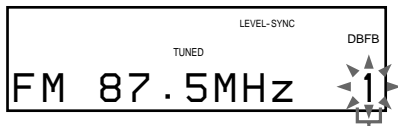

The preset number

---

**7** Press ENTER/YES on the remote.  
The station is stored.

---

**8** Repeat steps 1 through 7 to preset other stations.

---

#### To tune in a station with a weak signal

Press TUNING MODE repeatedly until "MANUAL" appears in step 2, then press TUNING +/- to tune in the station and continue from step 4.

#### To change the preset number

Start again from step 1.

#### To change the AM/MW tuning interval (except for European model)

The AM/MW tuning interval is factory-set to 9 kHz (10 kHz in some areas). To change the AM/MW tuning interval, tune in any AM/MW station first, then turn off the power. While holding down the FUNCTION button, turn the power back on. When you change the interval, all the AM/MW preset stations are erased. To reset the interval, repeat the same procedure.

#### Tips

- The preset stations are retained for a day even if you disconnect the mains lead or if a power failure occurs.
- You can create titles for the preset stations (see page 45).
- To improve broadcast reception, reorient the supplied aerials or connect the optional external aerial.
- When an FM programme has static noise, press STEREO/ MONO until "MONO" appears. There will be no stereo effect, but the reception will improve. Press the button again to restore the stereo effect.



# Connecting optional A/V components and outdoor aerials

To enhance your system, you can connect optional components. Refer to the instructions of each component.

## Connecting audio components

Connect the plugs from the optional component to jacks of the same colour on the rear panel of this unit.

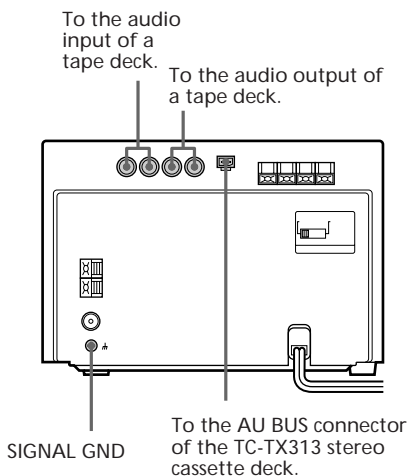

### Tip

When you connect the TC-TX313 stereo cassette deck to the DHC-MD313, be sure to use the AU BUS terminals.

## To listen to analogue components (except for the optional tape deck TC-TX313)

If the sound from a connected component is distorted, reduce the input level.

- 1 Press FUNCTION repeatedly until "TAPE" appears.
- 2 Turn off the system by pressing POWER.
- 3 While holding FUNCTION down, press POWER again.  
"Attenuate ON" appears and "ATT" flashes in the display.



To reset to the original level, repeat steps 1, 2, and 3.

**Connecting optional A/V components and outdoor aerials (continued)**

**Connecting outdoor aerials**

Connect an outdoor aerial to improve reception.

**FM aerial**

Connect an optional FM outdoor aerial or you can use a TV aerial instead.

**European model**

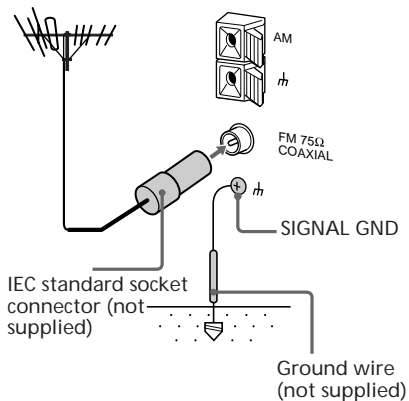

**Other models**

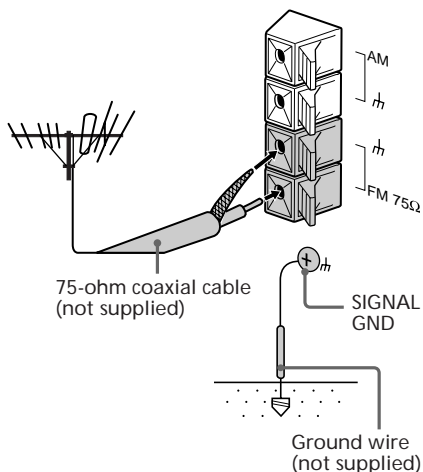

**AM aerial**

Connect a 6 to 15 meter (20 to 50 feet) insulated wire to the AM antenna terminal. Leave the supplied AM loop antenna connected.

**European model**

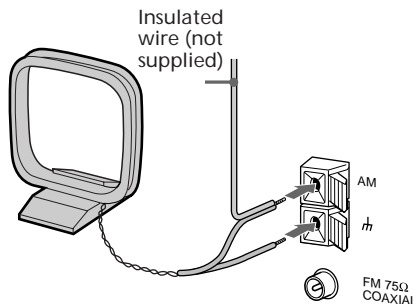

**Other models**

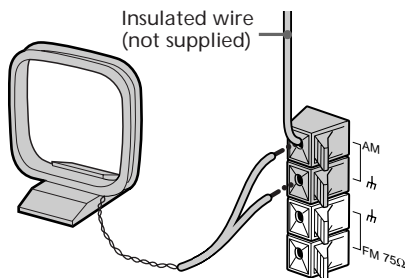

**Important**

If you connect an outdoor antenna, connect a ground wire to the h terminal with the screw clamp. To prevent a gas explosion, do not connect the ground wire to a gas pipe.

# Playing a CD

To turn on the system, press POWER.

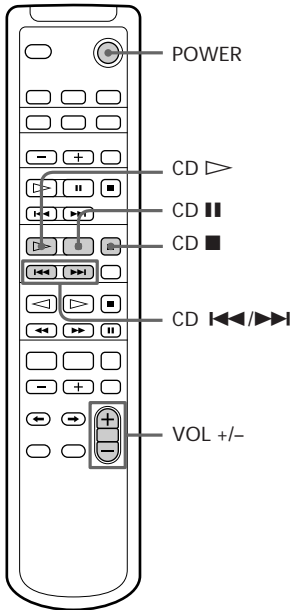
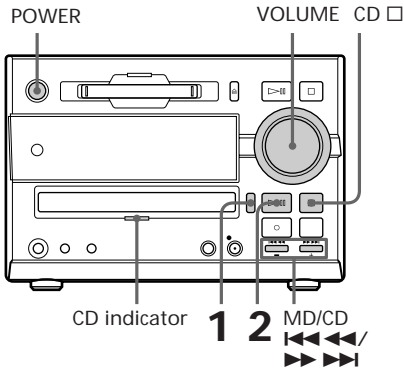

- 1 Press CD  $\square$  and place a CD on the disc tray.

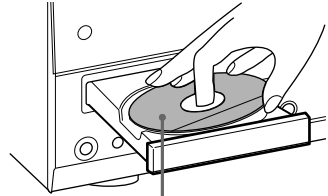

With the label side up.

The disc tray closes when you press the CD  $\square$  button again.

- 2 Press CD  $\triangleright \square$  (or CD  $\triangleright$  on the remote).

The disc tray closes and play starts. The  $\triangleright$  indicator on the CD  $\triangleright \square$  button is lit green.

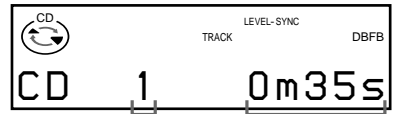

The track number      The playing time

| To                      | Do this   |
|-------------------------|---|
| Stop play               | Press CD $\square$ (or CD $\blacksquare$ on the remote).  |
| Pause                   | Press CD $\triangleright \square$ (or CD $\parallel$ on the remote). The $\parallel$ indicator on the CD $\triangleright \square$ button is lit orange. Press again to resume play. |
| Select a track          | Press MD/CD $\lllll$ (or CD $\lll$ on the remote) or MD/CD $\rrrrr$ (or CD $\rrr$ on the remote) repeatedly until you find the desired track.                                       |
| Find a point in a track | Press and hold MD/CD $\lllll$ or $\rrrrr$ , during play and release it at the desired point. "OVER" appears when the CD ends.   |
| Remove or exchange CD   | Press CD $\square$ .  |
| Adjust the volume       | Turn VOLUME (or press VOL +/- on the remote).   |

continued

## Playing a CD (continued)

### Tips

- You can start playing from the desired track in step 2.
  - 1 Press MD/CD ◀◀◀◀ or ▶▶▶▶ repeatedly until you find the desired track.
  - 2 Press CD ▷▶▶.
- Pressing CD ▷▶▶ (or CD ▷ on the remote) when the power is off automatically turns the power on and starts CD play if there is a CD on the disc tray (One Touch Play).
- If there is a CD on the disc tray, turn the power on. The CD indicator is lit red.
- You can switch from another source to the CD player and start playing a CD by pressing CD ▷▶▶ (or CD ▷ on the remote) (Automatic Source Selection).
- If there is no CD in the player, "CD NO DISC" appears in the display.

### Notes

- Do not use a CD with tape, seal or paste, on it as this may damage of the CD player.
- Do not push the disc tray closed, as this may damage the unit. Press CD ≡, to close the disc tray.

## Recording a CD on an MD

### — CD-MD Synchro Recording

You can make a digital recording of a CD on an MD, marking track numbers in the same sequence as the original CD. If you use a recorded MD, the MD deck automatically locates the end of the recorded portion and starts recording from there. You can also record a programme of favorite tracks (see page 29).

To turn on the system, press POWER.

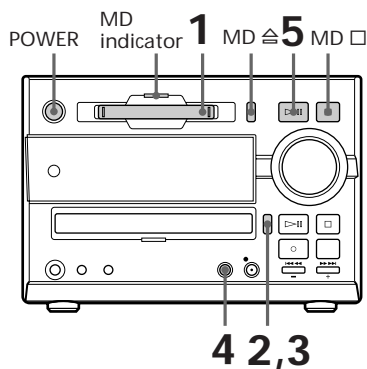

### 1 Insert a recordable MD.

With the arrow pointing toward the deck.

With the label side up and the shutter slide rightward.

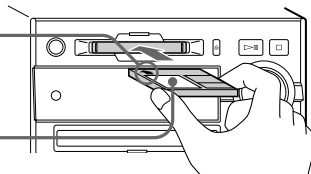

- Press CD  and place a CD on the disc tray.  
The disc tray opens.

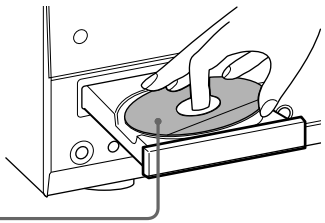



With the label side up.

- Press CD  to close the disc tray.

- Press CD-MD SYNC.  
The MD deck stands by for recording and the CD pauses at the beginning.



- Press MD  .  
Recording starts. When the recording is completed the CD player stops and the MD deck pauses automatically. Press MD , the MD deck stops.

### To stop recording

Press MD .

### Before inserting an MD

When the power is on, make sure the MD indicator is off. If the MD indicator is lit red, another MD is already inserted. Press MD  and remove the MD.

### Tip

The MD is labeled with the disc title of the CD automatically (see page 22) when using a new recordable MD or an MD whose tracks have been completely erased (see page 39) (Disc Memo Copy function).

### While "TOC" is lit or is flashing

To ensure complete recording, do not move the deck or disconnect the mains lead. The deck updates the Table of Contents (TOC) while "TOC" is flashing.

### If the MD ends during recording

The CD and the MD stops automatically.

### Notes

- The MD recording is complete only after all the recording information is entered to TOC at which point TOC stops flashing and goes out. Be careful disconnect the mains lead or move the deck before this point. Before disconnecting the mains lead, do the following:
  - Remove the MD.
  - Press POWER, to turn off the system.
- If the MD is record protected, "MD Protected" appears in the display and the MD cannot be recorded on.  
Press MD  and remove the MD, slide the record protection tab to the closed position (see page 28), reinsert the MD and try again.

# Playing an MD

To turn on the system, press POWER. You can play an MD just like a CD.

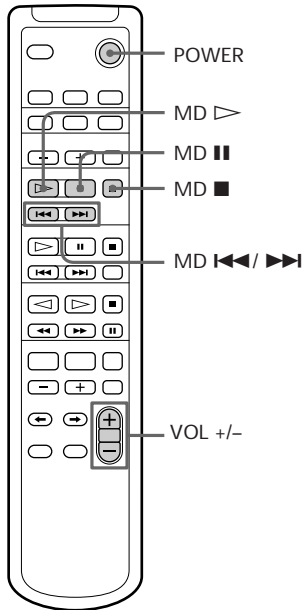
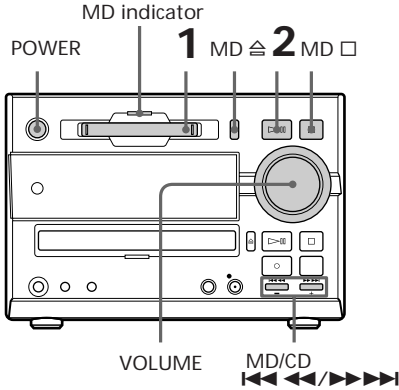

## 1 Insert an MD.

With the arrow pointing toward the deck.

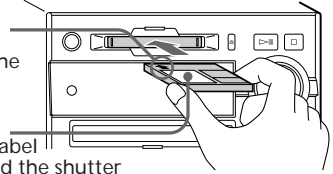

With the label side up and the shutter slide rightward.

## 2 Press MD > || (or MD > on the remote).

Play starts. The > indicator on the MD > || button is lit green.

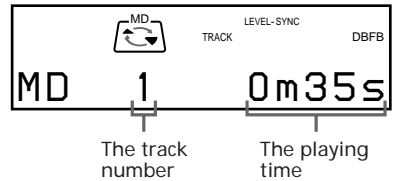









| To                      | Do this   |
|-------------------------|---|
| Stop play               | Press MD □ (or MD ■ on the remote).   |
| Pause                   | Press MD >    (or MD    on the remote). The    indicator on the MD >    button is lit orange. Press again to resume play.         |
| Select a track          | Press MD/CD <<<< (or MD <<<< on the remote) or MD/CD >>>> (or MD >>>> on the remote) repeatedly until you find the desired track. |
| Find a point in a track | Press MD/CD <<<< or >>>> during play and release it at the desired point.   |
| Remove the MD           | Press MD ≡.   |
| Adjust the volume       | Turn VOLUME (or press VOL +/- on the remote).   |

## Before inserting an MD

When the power is on, make sure the MD lamp is off. If the MD indicator is lit red, another MD is already inserted. Press MD  and remove the MD.

### Tips

- You can start playing from the desired track.
  - 1 Press MD/CD  (or MD  on the remote) or MD/CD  (or MD  on the remote) repeatedly until the desired track appears in the display.
  - 2 Press MD .
- Pressing MD  (or MD  on the remote) when the power is off automatically turns the power on and starts MD play if there is an MD in the player (One Touch Play).
- You can switch from another source to the MD deck and start playing an MD by pressing MD  (or MD  on the remote) (Automatic Source Selection).

## Listening to the radio

Preset radio stations in the tuner's memory first. To turn on the system, press POWER.

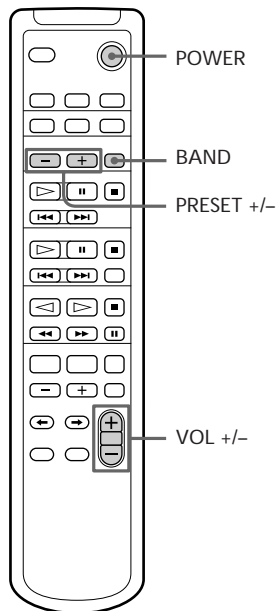
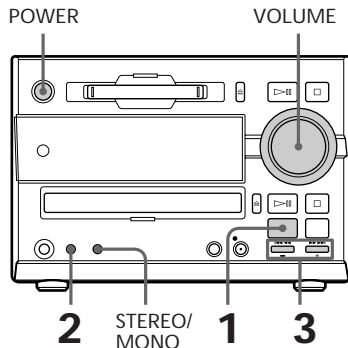

continued

## Listening to the radio (continued)

- 1 Press TUNER/BAND (or BAND on the remote) repeatedly until the band you want appears.

Each time you press the button, the band changes as follows:

North American model:

FM → AM

European model:

FM → MW → LW

Other models:

FM → MW → SW

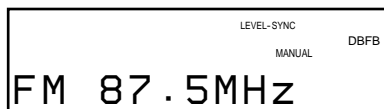

- 2 Press TUNING MODE repeatedly until "PRESET" appears.

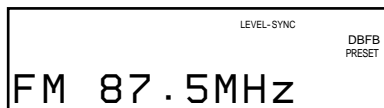

- 3 Press TUNING + or - (or PRESET + or - on the remote) to select the desired station's preset number.



Frequency or the station name\* or RDS station name\*\*

The preset number

\* If you label a preset station, it appears in the display.

\*\* European model only.

| To                 | Do this                                       |
|--------------------|---|
| Turn off the radio | Press POWER to turn off the system.           |
| Adjust the volume  | Turn VOLUME (or press VOL +/- on the remote). |

### To listen to non-preset radio stations

- Press TUNING MODE repeatedly until "MANUAL" appears in step 2, then press TUNING + or - to tune in the desired station. (Manual Tuning).
- Press TUNING MODE repeatedly until "AUTO" appears in step 2, then press TUNING + or -. The frequency indication changes and scanning stops when the system tunes in a station (Automatic Tuning).

### To cancel the Automatic Tuning

Press TUNER/BAND.

#### Tips

- Pressing TUNER/BAND (or BAND on the remote) when the power is off automatically turns the power on and tunes in the last received station (One Touch Play).
- You can switch from another source to the tuner by pressing TUNER/BAND (or BAND on the remote) (Automatic Source Selection).
- To improve broadcast reception, reorient the supplied aerials or connect the optional external aerial.
- When an FM programme has static noise, press STEREO/ MONO until "MONO" appears. There will be no stereo effect, but the reception will improve. Press the button again to restore the stereo effect.



# Recording from the radio

You can record a radio programme on an MD. If you use an MD with tracks already recorded on it, the MD deck automatically locates the end of the recorded section of the MD and starts the new recording from there. To record after erasing all tracks on an MD, see page 39.

To turn on the system, press POWER.

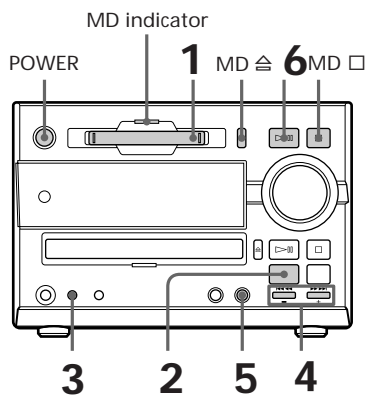

## 1 Insert a recordable MD.

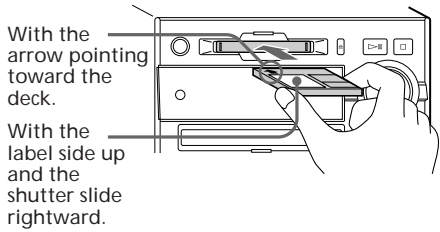

## 2 Press TUNER/BAND (or BAND on the remote) repeatedly until the band you want appears.

## 3 Press TUNING MODE repeatedly until "PRESET" appears.

## 4 Press TUNING + or - (or PRESET + or - on the remote) to select the desired station's preset number.

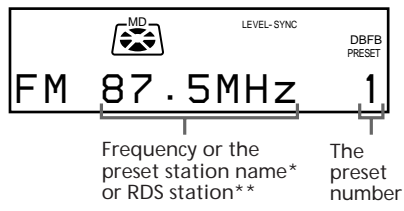

\* The titles you entered appear sequentially (see "Labelling the preset station" page 45).  
\*\* European model only.

## 5 Press ● REC. The MD stands by for recording and REC button is lit red.

## 6 Press MD ▷◁ (or MD ▷ or MD ◁ on the remote). Recording starts.

### To stop recording

Press MD ◻.

### To record non-preset radio stations

To record non-preset stations, press TUNING MODE repeatedly until "MANUAL" appears in step 3, then press TUNING + or - to tune in the desired station.

### Tip

If noise is heard while recording an AM radio station, reorient the AM loop aerial to reduce the noise.

continued

## Recording from the radio (continued)

### While "TOC" is lit or is flashing

To ensure complete recording, do not move the deck or disconnect the mains lead. The deck updates the Table of Contents (TOC) while "TOC" is flashing.

### Notes

- The MD recording is complete only after all the recording information is entered to TOC at which point TOC stops flashing and goes out. Be careful disconnect the mains lead or move the deck before this point. Before disconnecting the mains lead, do the following:
  - Remove the MD.
  - Press POWER, to turn off the system.
- If the MD is record protected, "MD Protected" appears in the display. Press MD  and remove the MD, slide the record protection tab to the closed position (see page 28), insert the MD and try again.

## Playing the CD tracks repeatedly

### -- Repeat Play

You can repeat a CD in normal play, Shuffle Play and Programme Play.

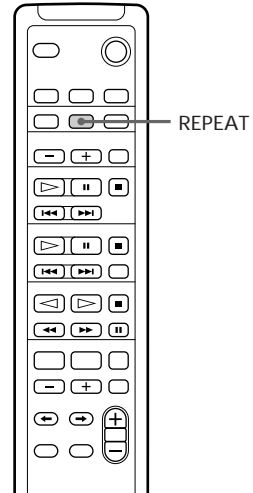

Press REPEAT during play until "REPEAT" or "REPEAT 1" appears.

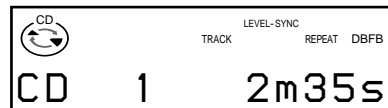

REPEAT: For all the tracks on the current CD.  
REPEAT 1 : For a single track only.

\* You cannot repeat only one track during Shuffle Play and Programme Play.

### To cancel Repeat Play

Press REPEAT until "REPEAT" or "REPEAT 1" disappears.

# Playing the CD tracks in random order

## -- Shuffle Play

You can play all the tracks on a CD in random order.

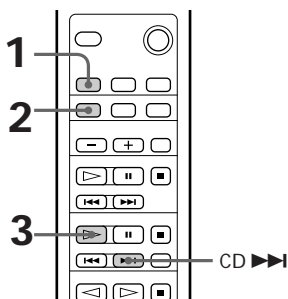

**1** Press FUNCTION repeatedly until "CD" appears, then place a CD on the disc tray.

**2** Press PLAY MODE repeatedly until "SHUFFLE" appears.

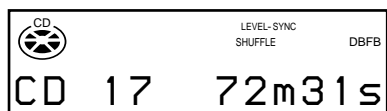

**3** Press CD ▷. Shuffle Play starts. "CD" appears, and all the tracks play in random order.

### To cancel Shuffle Play

Press PLAY MODE repeatedly until "SHUFFLE", "PGM" disappears.

### Tips

- You can start Shuffle Play during normal play by displaying "SHUFFLE."
- To skip a track press CD ►►.

# Programming the CD tracks

## -- Programme Play

You can make a programme of up to 24 tracks from all the CDs in the order you want them to be played. You can make a Synchro Recording of the programme on the MD (see pages 29).

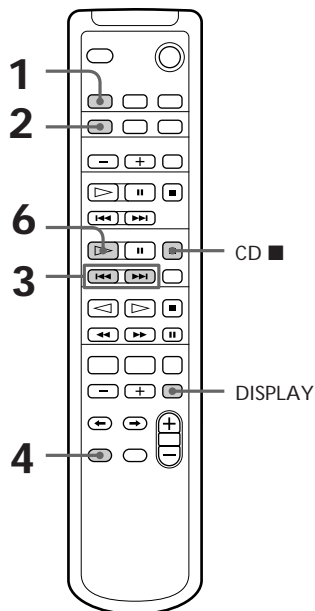

**1** Press FUNCTION repeatedly until "CD" appears in the display, then place a CD on the disc tray.

**2** Press PLAY MODE repeatedly until "PGM" appears.

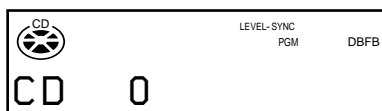

## Programming the CD tracks (continued)

- 3** Press CD ►► or ◀◀ until the desired track appears in the display.

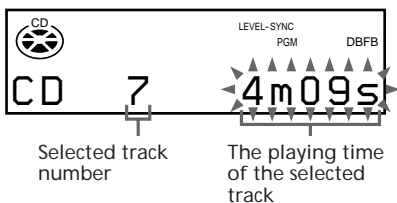

- 4** Press ENTER/YES.  
The track is programmed.  
The number of the last programmed track appears, followed by the total playing time of the programme. "Step" appears, followed by the total number of programmed steps.

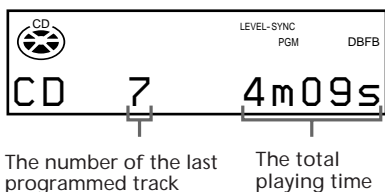

- 5** To programme additional tracks, repeat steps 3 and 4.

- 6** Press CD ▷.  
All the tracks play in the order you selected.

## To check the total number of programmed tracks

Press DISPLAY in stop mode. The total number of programmed tracks appears, followed by the number of the last programmed track and the total playing time of the programme.

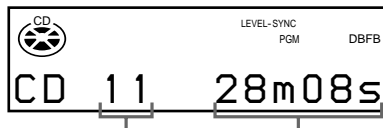

The number of the last programmed track

The total playing time of the programmed tracks

## To check the programmed track number

Press CD ►► repeatedly during the Programme Play.

### Additional tasks

| To  | Do this   |
|---|---|
| Cancel Programme Play                       | Press CD ■, then press PLAY MODE repeatedly until "PGM" or "SHUFFLE" disappear. |
| Add a track to the programme (in stop mode) | Do steps 1 to 5.  |
| Erase the entire programme                  | Press CD ■, the Programme Play in stop mode.                                    |

### Tip

The programme you made remains after Programme Play finishes. To play the same programme again, press CD ▷.

# Using the CD display

You can check the remaining time of the current track or that of the CD.

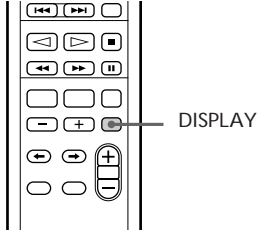

Press DISPLAY repeatedly during play. Each time you press the button, the display changes as follows:

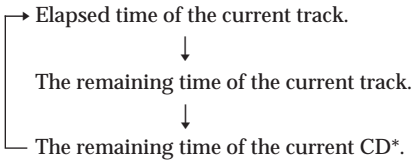

\* The remaining time of the programme is displayed during Programme Play.

## To check the total playing time and number of tracks on the CD

The total playing time and number of the tracks are displayed during normal or shuffle play in stop mode.

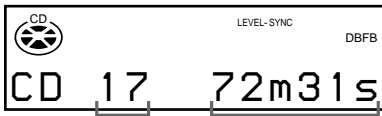

The total number of the tracks

The total playing time

# Looping part of a CD track

## — Loop

With the loop function (NORMAL, RHYTHM), you can repeat part of a CD track during play. This lets you manipulate recordings. You can choose from five loop lengths ranging from 0.25 (“NORMAL 1” or “RHYTHM 1”) to 1 second (“NORMAL 5” or “RHYTHM 5”).

## The difference between NORMAL and RHYTHM

### Original

Hey, Come on everybody! ...

### NORMAL

The track pauses while the loop plays, then resumes play from the same point when you release the button.

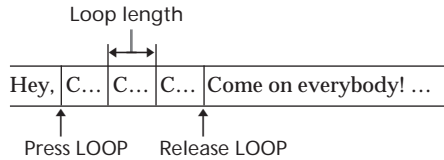

### RHYTHM

The track continues unheard while the loop plays, then resumes play from where you release the button.

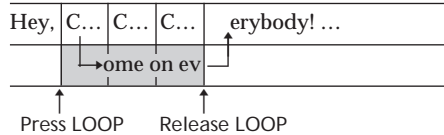

■ : Unheard portion overlapped by the loop.

## Looping part of a CD track (continued)

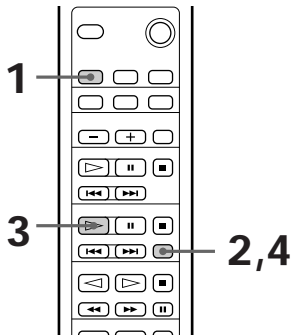

**1** Press FUNCTION repeatedly until “CD” appears and place a CD on the disc tray.

**2** Press LOOP repeatedly during pause or stop mode to select “NORMAL 1 - 5” or “RHYTHM 1 - 5.”

Each time you press the button, the display changes as follows:

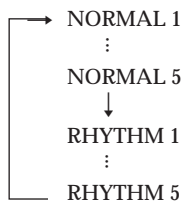

**3** Press CD ▷.

**4** Press and hold LOOP at the point you want to start the Loop function, and release the button at the point you want to resume normal play.

## Labelling a CD

### -- Disc Memo Function

You can label up to 20 CDs with titles of up to 12 symbols and characters. Whenever you load a labelled CD, the title (disc name) appears in the display. If you label a CD and make a CD -MD Synchro Recording on a new MD, the title is automatically recorded on the MD.

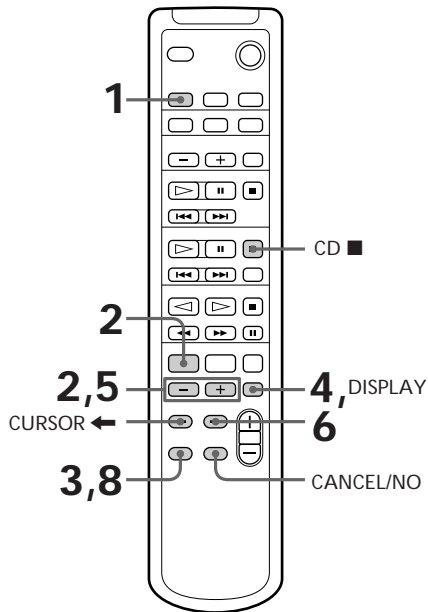

**1** Press FUNCTION repeatedly until “CD” appears, then place a CD on the disc tray.

Make sure the CD is stopped and the total number of tracks and the playing time appear in the display.

If “SHUFFLE” or “PGM” appears in the display, press PLAY MODE repeatedly until it disappears.

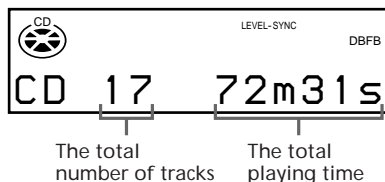

- 
- 2** Press EDIT and press +/- repeatedly until “Name in ?” appears.



- 
- 3** Press ENTER/YES.  
The cursor flashes.

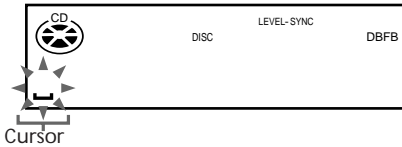

- 
- 4** Press CHARACTER repeatedly until the type of character you want appears.

Each time you press the button, the display changes as follows:

A (Upper case) → a (Lower case) → 0 (Numbers) → ! (Symbols)\* →  $\square$  (Space) → A...

\* You can use the following symbols.

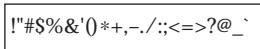

- 
- 5** Press +/- repeatedly until the desired character appears.  
To enter a blank space, skip this step.

- 
- 6** Press CURSOR →.  
The character you selected in step 5 stops flashing and the cursor shifts to the right.

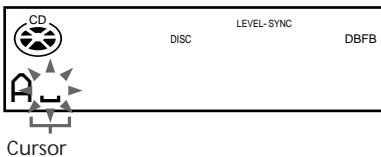

- 
- 7** Repeat steps 4 through 6 to complete the entire title.

If you enter an incorrect character, press CURSOR ← or → until the character you want to change flashes, then repeat steps 4 through 6.

To erase a character, press CANCEL/NO while the character is flashing. You cannot insert characters between previously inserted characters.

- 
- 8** Press ENTER/YES to complete the labelling procedure.

Start over from step 1 and the titles entered appear sequentially.

---

### To cancel labelling

Press EDIT.

### Note

Turn on the system POWER at least once a month, otherwise the titles are erased from the memory.

### To check the titles

Press DISPLAY while playback is stopped.

Each time you press the button, the display changes as follows:

The disc title



The total number of tracks and the total playing time

### To erase a disc title

1 Press EDIT then press +/- repeatedly until “Name Erase ?” appears.

2 Press ENTER/YES.

The disc title flashes.

“No Name” appears if there is no disc title is stored.

3 Press +/- repeatedly until the disc title you want to erase disappears.

4 Press ENTER/YES again.

“Complete” appears and the disc title is erased.

### To cancel erasing

Press CANCEL/NO.

## Playing the MD tracks repeatedly

### — Repeat Play

You can repeat a single track or all the tracks on a disc.

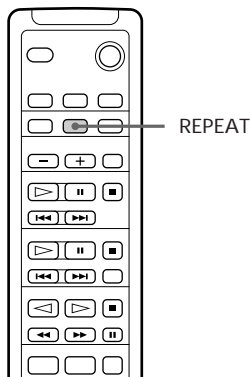

Press REPEAT during play until “REPEAT” or “REPEAT 1” appears.

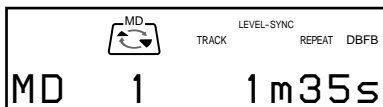

REPEAT: For all the tracks on the current MD.

REPEAT 1\*: For a single track only.

\* You cannot repeat a single track during Shuffle Play and Programme Play.

### To cancel Repeat Play

Press REPEAT until “REPEAT” or “REPEAT 1” disappears.

## Playing the MD tracks in random order

### — Shuffle Play

You can play the tracks in random order.

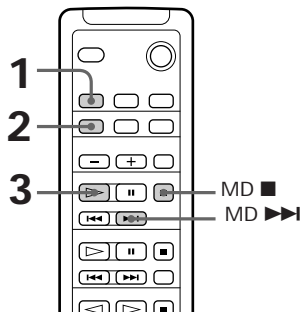

**1** Press FUNCTION repeatedly until “MD” appears, then insert an MD.

**2** Press PLAY MODE repeatedly until “SHUFFLE” appears, in stop mode.

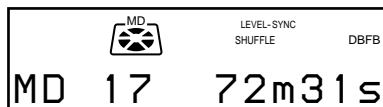

**3** Press MD ▷. Shuffle Play starts. “f” appears, and all the tracks play in random order.

### To cancel Shuffle Play

Press MD ■ to stop the Shuffle Play, then press PLAY MODE repeatedly until “SHUFFLE” disappears.

### Tip

To skip tracks, press MD ▷▷.



# Programming the MD tracks

## — Programme Play

You can make a programme of up to 25 tracks in the order you want them to be played.

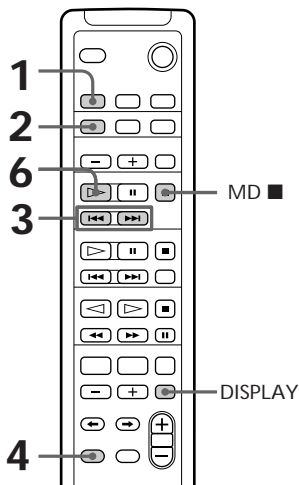

**1** Press FUNCTION repeatedly until “MD” appears, then insert an MD.

**2** Press PLAY MODE repeatedly until “PGM” appears, in stop mode.

**3** Press MD ►► or ◀◀ repeatedly until the desired track number appears in the display.

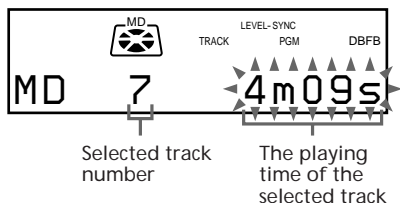

**4** Press ENTER/YES.

The track is programmed. The order number of the programmed track appears, followed by the total playing time of the programme. “Step” appears, followed by the total number of programmed tracks.

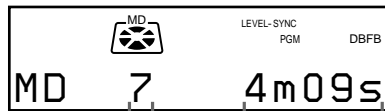

The number of the last programmed track

The total playing time

**5** To programme additional tracks, repeat steps 3 and 4.

**6** Press MD ►.

All the tracks play in the order you selected.

### To check the total number of programmed tracks

Press DISPLAY in stop mode.

The last programmed track number and the total number of programmed tracks appears.

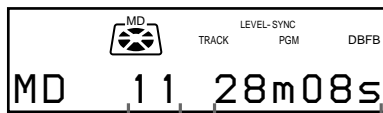

The last number of the programmed tracks

The total playing time of the programmed tracks

### To check the programmed track number

Press MD ►► repeatedly during the Programme Play.

## Programming the MD tracks (continued)

### Additional tasks

| To  | Do this  |
|---|--|
| Cancel Programme Play                       | Press MD ■ to stop the Programme Play, then press PLAY MODE repeatedly until "PGM" or "SHUFFLE" disappear. |
| Add a track to the programme (in stop mode) | Do step 1 and 4.   |
| Erase the programme                         | Press MD ■, the Programme Play in stop mode.   |

### Tip

The programme you made remains after Programme Play finishes. To play the same programme again, press MD ▷.

## Using the MD display

You can check the remaining time and total playing time of an MD.

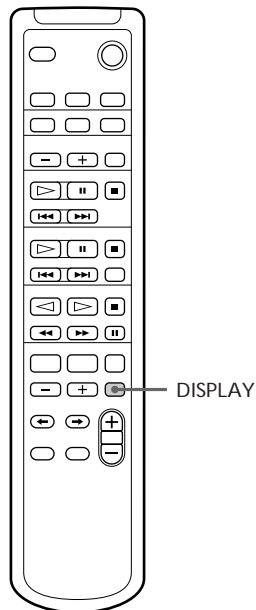

## Checking the remaining time of a track

Press DISPLAY during play. Each time you press the button, the display changes as follows:

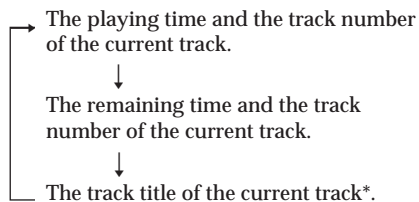

\* "No Name" appears if no track title is stored. To label a disc, see page 37.

# Checking the remaining time of a disc

---

Press DISPLAY in stop mode.

Each time you press the button, the display changes as follows:

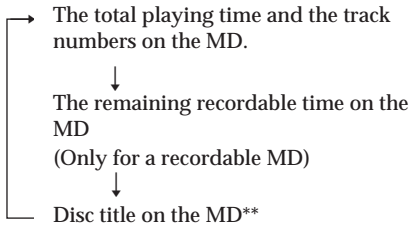

\*\* "No Name" appears if no disc title is stored.  
To label a disc, see page 37.

---

## Before you start recording

MDs (Mini Disc) let you digitally record and play music with high quality sound comparable with the sound of CDs. Another feature of MDs is track marking. The track marking feature lets you quickly locate a specific point or easily edit the recorded tracks. However, depending on the source you record, the recording method varies. Also, the way the track numbers are recorded differs depending on the source.

### When the source you record from is:

#### • This system's CD player

- The digital signal from the CD is recorded as it is (digital recording)\*.
- Track numbers are automatically marked as on the original CD.

#### • This unit's tuner and other analogue components (e.g., the optional tape deck TC-TX313)

- The analogue signal is converted to a digital signal and recorded (analogue recording).\*\*
- A track number is marked at the beginning of a recording, but when you turn on the Level Sync function (see page 33), track numbers are automatically marked in sync with the level of the input signal.

\* For details on the limitations for digital recording, see page 52.

\*\*This signal is converted because these systems do not use digital signals.

### Note on MD track numbers

On an MD, the track number (track sequence), track start and end point information, etc., are recorded in the TOC\* area independent of the sound information. You can edit recorded tracks quickly by modifying the TOC information.

\* TOC: Table Of Contents.

## After recording

- ➔ Press MD  $\text{⏏}$  to remove the MD or press POWER to turn off the system power.

The MD recording is complete only after the recording information is entered to TOC, and "TOC" is lit or is flashing.

### Note

The MD recording is complete only after all the recording information is entered to TOC at which point TOC stops flashing and goes out. Be careful disconnect the mains lead or move the deck before this point. Before disconnecting the mains lead, do the following:

- Remove the MD.
- Press POWER, to turn off the system.

### Protecting a recorded MD

- To protect a recorded MD, slide the tab on the side of the MD to open the slot.

In this position, the MD cannot be recorded on.

To record on the MD, slide the tab to close the slot.

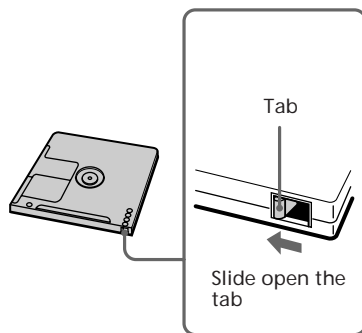

- If the MD is record protected, "MD Protected" appears in the display and the MD cannot be recorded on. Slide the tab to closed position reinsert the MD and try again.

# Recording the favorite CD tracks on an MD

You can select your favorite CD tracks with the Programme Play feature, then record the programme on an MD using the CD Synchro Recording feature.

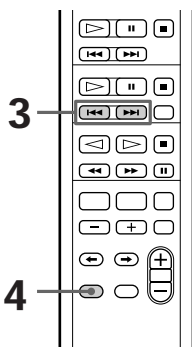
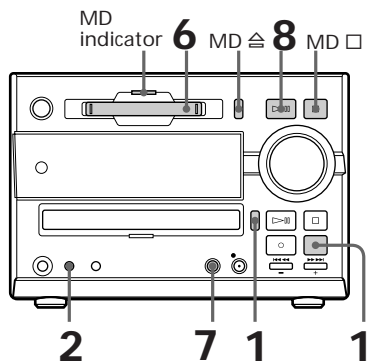

## Step 1: Selecting the tracks

- 1 Press **FUNCTION** repeatedly until "CD" appears, then place a CD on the disc tray.
- 2 Press **PLAY MODE** repeatedly until "PGM" appears.

- 3 Press **CD**  $\triangleright\triangleright$  or  $\triangleleft\triangleleft$  repeatedly until the desired track number appears.

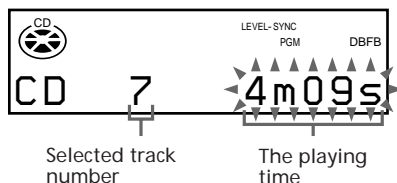

- 4 Press **ENTER/YES**.  
The track is programmed. The number of the programmed track appears, followed by the total playing time of the programme. "Step" appears, followed by the total number of programmed tracks.

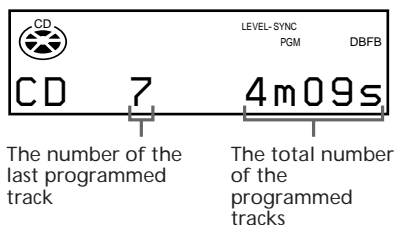

- 5 To program additional tracks, repeat steps 3 and 4.

## Step 2: Recording on an MD

- 6 Insert a recordable MD.  
If the MD indicator is lit red, another MD is already inserted, press **MD**  $\triangle$  and remove the MD.
- 7 Press **CD-MD SYNC**.  
The MD deck stands by for recording and the CD is in pause for playback. If you use an MD with tracks already recorded on it, the MD deck automatically locates the end of the recorded portion and starts the new recording from there.

## Recording the favorite CD tracks on an MD (continued)

### 8 Press MD ▷◻.

Recording starts from the last recorded portion of the MD. The CD player stops and the MD deck pauses automatically when the recording is completed. If there is no remaining recording time on the MD, the MD deck stops.

### To stop recording

Press MD ◻.

If the MD ends while recording, the MD and the CD automatically stops.

### Tip

The MD is labeled with the disc title of the CD (see page 22) when using a new recordable MD or an MD whose tracks have been completely erased (see page 39) (Disc Memo Copy function).

### While "TOC" is lit or is flashing

To ensure complete recording, do not move the deck or pull out the mains lead. The deck updates the Table of Contents (TOC) while "TOC" is flashing.

### Notes

- The MD recording is complete only after all the recording information is entered to TOC at which point TOC stops flashing and goes out. Be careful disconnect the mains lead or move the deck before this point. Before disconnecting the mains lead, do the following:
  - Remove the MD.
  - Press POWER, to turn off the system.
- If the MD is record protected, "MD Protected" appears in the display and the MD cannot be recorded on. Press MD ≡ and remove the MD, slide the record protection tab to the closed position (see page 28), reinsert the MD and try again.

## Recording on an MD manually

The system automatically locates the end of any recorded portion of an MD and starts recording from that point.

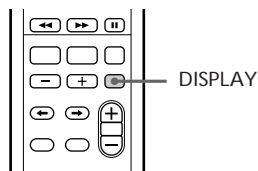
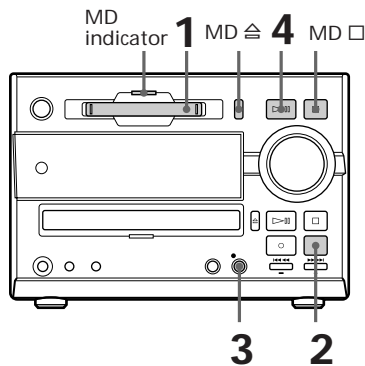

- 1** Insert a recordable MD.  
If the MD indicator is lit red, another MD is already inserted, press MD ≡ and remove the MD.
- 2** Press FUNCTION to select the source (e. g., CD) you want to record.
  - CD : Recording from the CD.
  - TUNER : Recording from the radio.
  - TAPE : Recording from other components.
- 3** Press ● REC.  
The MD deck is now ready for recording.
- 4** Press MD ▷◻.  
Recording starts.

**5** Start playing the source you want to record.

When recording from this system's CD player, the track numbers are automatically marked. Press ● REC while recording to the mark track numbers. (see "Marking track numbers" page 33).

### To stop recording

Press MD □.

### If "Level Over" appears in the level meter

A high-level signal was input during recording in the tape function. When the sound distorted reduce the recording level (see page 54), then re-record.

### While "TOC" is lit or is flashing

To ensure complete recording, do not move the deck or pull out the mains lead. The deck updates the Table of Contents (TOC) while "TOC" is flashing.

### Tip

You can change the recording time and the remaining time in the display while recording by pressing DISPLAY on the remote.

### Notes

- The MD recording is complete only after all the recording information is entered to TOC at which point TOC stops flashing and goes out. Be careful disconnect the mains lead and move the deck before this point. Before disconnecting the mains lead, do the following:
  - Remove the MD.
  - Press POWER, to turn off the system.
- If you pause recording during CD recording, a track number is recorded at that point. Also, note that the tracks are recorded as a single track with a single track number when a single track of the same CD is recorded repeatedly.

## Starting recording with 6 seconds of prestored audio data

### — Time Machine Recording

When recording from an FM or satellite broadcast, the first few seconds of material are often lost due to the time it takes you to ascertain the contents and press the record button. To prevent the loss of this material, the Time Machine Recording feature constantly stores 6 seconds of the most recent audio data in a buffer memory. When you start recording the sound source, the recording actually starts with the 6 seconds of audio data stored in the buffer memory in advance, as shown in the illustration below:

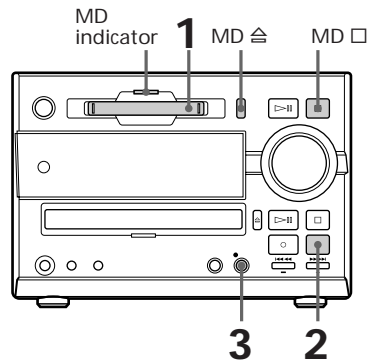
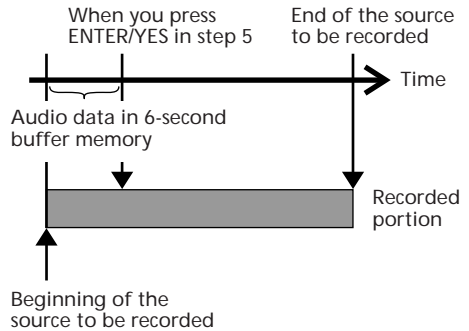

## Starting recording with 6 seconds of prestored audio data (continued)

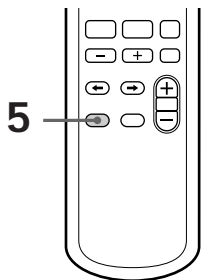

- 1** Insert a recordable MD.
- 2** Press FUNCTION repeatedly to select the source (e.g., TUNER) you want to record.
- 3** Press ● REC.  
The deck stands by for recording.
- 4** Start playing the source you want to record.
- 5** Press ENTER/YES on the remote at the point you want to start recording.  
Recording of the source starts with the 6 seconds of audio data stored in the buffer memory.  
If you use an MD with tracks already recorded on it, the MD deck automatically locates the end of the recorded portion and starts the new recording from there.

## To stop Time Machine Recording

Press MD □.

## While "TOC" is lit or is flashing

To ensure complete recording, do not move the deck or pull out the mains lead. The deck updates the Table of Contents (TOC) while "TOC" is flashing.

## Notes

- The MD recording is complete only after all the recording information is entered to TOC at which point TOC stops flashing and goes out. Be careful disconnect the mains lead or move the deck before this point. Before disconnecting the mains lead, do the following:
  - Remove the MD.
  - Press POWER, to turn off the system.
- The MD deck starts storing audio data when the deck is in recording pause in step 3 and you start playing the source. If you press ENTER/YES on the remote within 6 seconds of this point then Time Machine Recording starts with less than 6 seconds of audio data.



# Marking track numbers

When you record from this system's CD (digital recording), the track numbers are automatically marked. In addition, you can mark track numbers:

- At any point while recording.
- Automatically while analog recording.

## Marking track numbers at a specific point while recording

### -- Level-Synchro Recording

The "LEVEL-SYNC" is factory set to ON. If "LEVEL-SYNC" disappears, do step 1 through 5 to turn ON. Track numbers are automatically marked when the input signal is under a certain level for more than two seconds and then exceed the previous level.

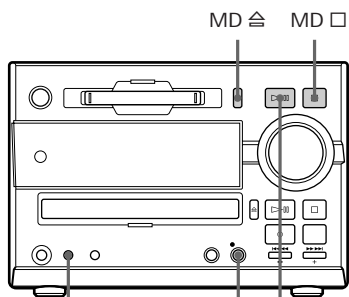

2 1 6

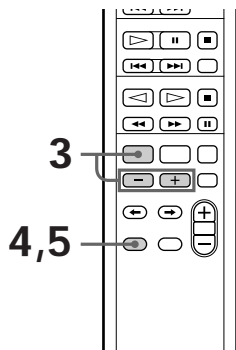

- 1 Press ● REC. The MD stands by for recording.
- 2 Press PLAY MODE until "PGM" or "SHUFFLE" disappears.
- 3 Press EDIT then press +/- repeatedly until "LevelSync ?" appears.
- 4 Press ENTER/YES. "LevelSync ON ?" appears.
- 5 Press ENTER/YES again. "LEVEL-SYNC" lights up.
- 6 Press MD ▷◁. Recording starts.

### To stop recording

Press MD □.

### To cancel automatic track marking

- 1 Press EDIT during recording.
- 2 Press +/- repeatedly until "LevelSync ?" appears.
- 3 Press ENTER/YES. "LevelSync OFF ?" appears.
- 4 Press ENTER/YES again. "LEVEL-SYNC" disappears.

When "LEVEL-SYNC" disappears, a track number is marked only at the beginning of each recording.

### Notes

- You may not mark track numbers automatically if the sound source to be recorded is noisy (e.g., tapes or radio programmes).
- The MD recording is complete only after all the recording information is entered to TOC at which point TOC stops flashing and goes out. Be careful disconnect the mains lead or move the deck before this point. Before disconnecting the mains lead, do the following:
  - Remove the MD.
  - Press POWER, to turn off the system.

## Marking track numbers (continued)

### Marking track numbers at a specific point while recording

You can mark track numbers at any time while recording, regardless of the type of sound source.

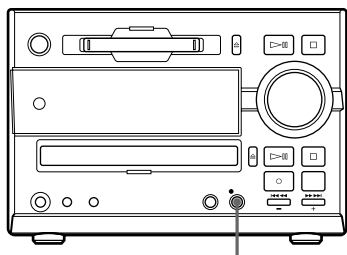

● REC

Press ● REC while recording at the point you want to add a track mark. The tracks following the added one are renumbered.

---

## Making a space between tracks 3 seconds long

— *Smart Space, Auto Cut*

The Smart Space and Auto Cut functions let you make a blank space between tracks three seconds long automatically while making a digital recording.

### Smart Space

If there is extended silence of 4 to 29 seconds while digital recording, the MD deck replaces the silence with a blank of about 3 seconds and continues recording.

### Auto Cut

If there is no sound input for 30 seconds while digital recording, the MD deck replaces the silence of 30 seconds with a blank of about 3 seconds and changes to recording pause.

### Notes

- The Smart Space and Auto Cut functions are factory set to on.
- If you turn the power off or disconnect the mains lead, the MD deck will recall the last setting (on or off) of the Smart Space and Auto Cut functions the next time you turn the power on.
- The MD recording is complete only after all the recording information is entered to TOC at which point TOC stops flashing and goes out. Be careful disconnect the mains lead or move the deck before this point. Before disconnecting the mains lead, do the following:
  - Remove the MD.
  - Press POWER, to turn off the system.

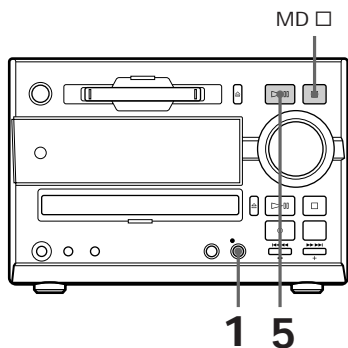

### To stop recording

Press MD □.

### To turn off the Smart Space and Auto Cut functions

- 1 Press EDIT during recording pause.
- 2 Press +/- repeatedly until "S. Space ?" appears.
- 3 Press ENTER/YES.  
"S. Space OFF ?" appears.
- 4 Press ENTER/YES again.

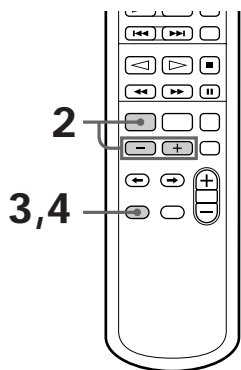

---

**1** Press ● REC, recording pause.

---

**2** Press EDIT repeatedly until  
"S. Space ?" appears.

---

**3** Press ENTER/YES.  
"S. Space ON ?" appears.

---

**4** Press ENTER/YES again.

---

**5** Press MD ▷ □□.  
Recording starts.

---

# Before you start editing

You can edit the recorded tracks on an MD. By using the editing functions, you can create a new sequence to the recorded MD.

## Editing functions

- **Name – Labeling MDs**  
Use this function to label discs and tracks. You can use upper case, numbers and symbols for the titles.
- **Erase – Erasing recordings**  
Use this Function to erase a single track one by one or all tracks at once.
- **Move – Changing the order of tracks**  
Use this Function to change the track numbering.
- **Divide – Marking track numbers on recorded radio programmes**  
Use this function to add track numbers. This lets you locate your favorite phrases quickly.
- **Combine – Combining recorded tracks**  
By using this function, the blank space between two tracks is erased and those two tracks are combined to one track. You can combine the tracks which are not numerically consecutive, i.e. the track 1 and track 4, etc.
- **Undo – Cancelling the last edit**  
Use this function to cancel the last edit and restore the contents of the MD to the condition before the edit.

## Before editing

To edit the MD, the MD deck requires the following conditions:

- The MD is writable.
  - The MD deck is in the Continuous mode.
- Before editing, check the conditions by following the procedure below.

- 
- 1 Check the tab of the MD to be edited.

If the MD is record protected, “MD Protected” appears in the display and the MD cannot be edited.

If the MD is protected against erasure, slide the tab to close the slot.

- 
- 2 Press PLAY MODE repeatedly until “PGM” or “SHUFFLE” disappear. You can edit the MD only in continuous mode. You cannot edit the MD in Shuffle or Programme mode.
- 

## After editing

- 
- ➔ Press MD  to remove the MD or press POWER to turn off the system power.
- The MD editing is complete only after the editing information is entered to TOC, and “TOC” is lit or is flashing.
- 

### Note

The MD editing is complete only after all the editing information is entered to TOC at which point TOC stops flashing and goes out. Be careful disconnect the mains lead or move the deck before this point. Before disconnecting the mains lead, do the following:

- Remove the MD.
- Press POWER, to turn off the system.

# Labelling an MD

## -- Name Function

If you have a labeled CD on a new MD, the title is automatically recorded on the MD (Disc Memo Copy function). You can also create titles (names) for your recorded MDs and tracks. You can use up to 1,700 characters for a disc.

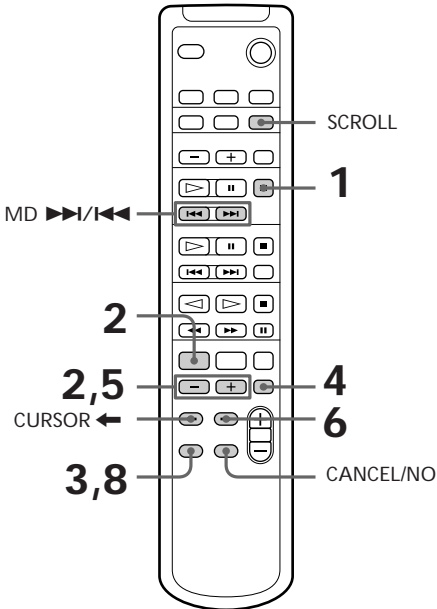

**1** To level a disc, press MD ■ to stop playing the disc.  
To level a track, press MD ►► or ◀◀ until the desired track number appears.

**2** Press EDIT then press +/- repeatedly until "Name in ?" appears.

**3** Press ENTER/YES.  
The cursor starts flashing.

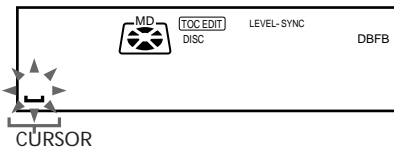

**4** Press CHARACTER repeatedly until the type of character you want appears.

Each time you press the button, the display changes as follows:

A (Upper case) → a (Lower case) → 0 (Numbers) → ! (Symbols)\* → ␣ (Space) → A...

\* You can use the following symbols.

!"#\$%&'()\*+,-./:;<=>?@\_`

**5** Press +/- repeatedly until the character you want appears.  
To enter a blank space, skip this step.

**6** Press CURSOR →.  
The character you selected in step 5 stops flashing and the cursor shifts to the right.

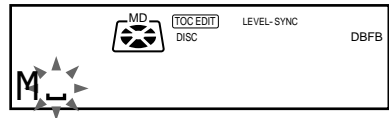

**7** Repeat steps 4 through 6 to complete the entire title.  
If you enter an incorrect character, press CURSOR ← or → until the character you want to change flashes, then repeat steps 4 through 6.  
To erase a character, press CANCEL/NO while the character is flashing. You cannot insert characters between previously inserted characters.

**8** Press ENTER/YES to complete the labelling procedure.  
The titles you labelled appears sequentially, then the display returns to the original.

### To cancel labelling

Press EDIT.

## Labelling an MD (continued)

### Note

- You can label a track title while playing, but you must complete labelling before the track ends.
- If the MD is record protected, “MD Protected” appears in the display and the MD cannot be recorded on.  
Press MD  and remove the MD, slide the record protection tab to the closed position (see page 28), insert the MD and try again.



### To check the titles (with the remote only)

To check the disc titles, press SCROLL while play is stopped. To check the track titles, press SCROLL while playing. The titles scroll across the display. To stop scrolling, press SCROLL. Press the button again to resume scrolling.

### To erase all titles

- 1 Press EDIT then press +/- repeatedly until “Name Erase ?” appears.
- 2 Press ENTER/YES. “Name Erase ??” appears. To cancel erasing at this time, press MD .
- 3 Press ENTER/YES again.  
All the track titles are erased.

### To erase a track title

- 1 Press MD  or  until the desired track title appears.
- 2 Press EDIT then press +/- repeatedly until “Name Erase ?” appears.
- 3 Press ENTER/YES.  
“Complete” appears.  
The track title you selected in step 1 is erased.

## Erasing recordings

### -- Erase Function

The MD deck lets you erase unwanted tracks quickly and easily. You can restore the contents to the condition before erasing (unerase) by using the Undo function.

Note, however, check carefully the portion to be erased, as you cannot undo an edit after performing any additional edits.

The three options for erasing recordings are:

- Erasing a single track.
- Erasing all tracks.
- Erasing a portion of a track.

### To erase a single track

You can erase a track simply by selecting its track number. When you erase a track, the total number of tracks on the MD decreases by one and all the tracks following the erased one are renumbered.

Eg.: Erasing track B.

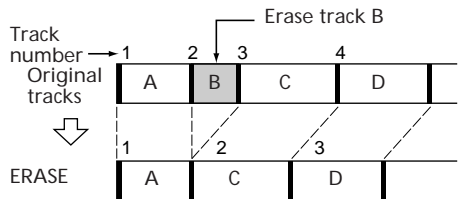

When erasing multiple tracks, you should proceed in order from high to low track number to prevent the renumbering of tracks that have not been erased yet.

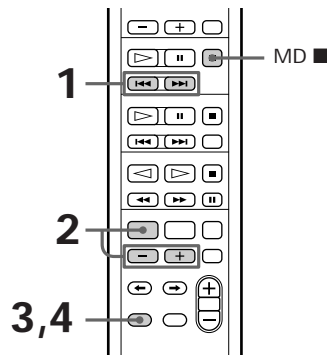

- 1 Press MD ►► or ◀◀ repeatedly until the track number you want to erase appears.

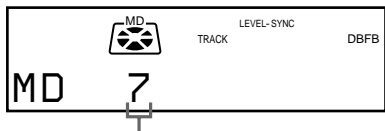

The track number you want to erase.

- 2 Press EDIT then press +/- repeatedly until “Erase ?” appears.



- 3 Press ENTER/YES.  
“Erase ??” appears.

- 4 Press ENTER/YES again to erase the track.  
“Complete” appears for a few seconds and the selected track and title are erased.

## To cancel erasing

Press EDIT.

### Note

“Erase!! ?” appears when the track was recorded or edited on another deck and is erase protected. To erase the track, press ENTER/YES while “Erase!! ?” appears.

## To erase all tracks

You can erase the entire MD (all titles and tracks) all at once.

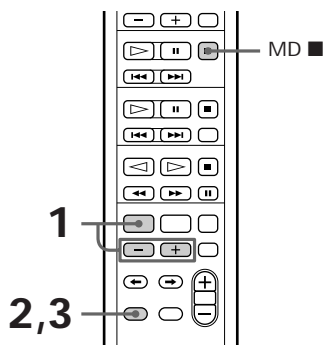

- 1 While the deck is stopped, press EDIT then press +/- repeatedly until “All Erase ?” appears.

- 2 Press ENTER/YES.  
“Erase ??” appears.

- 3 Press ENTER/YES.  
“Complete” appears for a few seconds and the selected track and title are erased.

## To cancel erasing.

Press EDIT.

## To erase a portion of a track

By using the Divide (see page 41), Erase, and Combine (see page 42) Functions, you can erase specific portions of a track.

Eg.: Erasing a portion of track A.

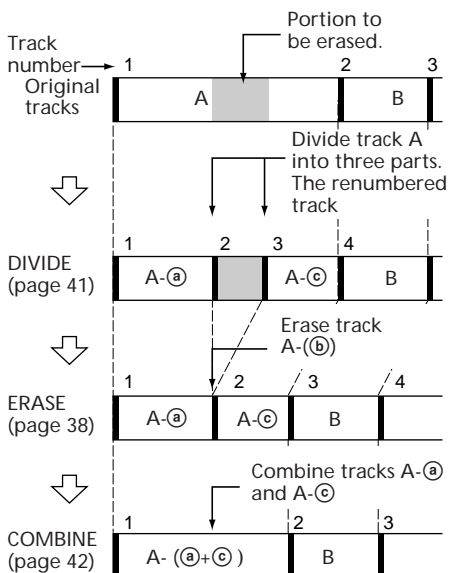

## Moving recorded tracks

-- Move Function

Using the Move Function, you can change the order of any track on the disc. When you move tracks, the tracks are automatically renumbered.

Eg.: Moving track C to position 2.

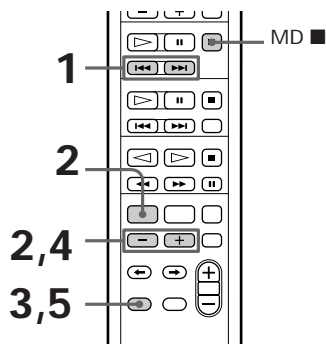
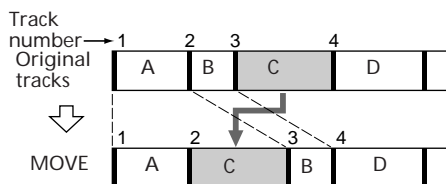

- 1 Press MD **▶▶▶** or **◀◀◀** repeatedly until the track number you want to move appears.
- 2 Press EDIT then press **+/-** repeatedly until "Move ?" appears.
- 3 Press ENTER/YES.



- Press +/- repeatedly until the track number you want to move the track to (new track number) appears.

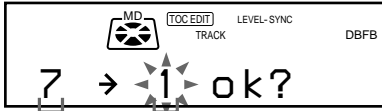

The original track number.      The number you want

- Press ENTER/YES. "Complete" appears for a few seconds and the selected track moves to appointed position.

### To cancel moving.

Press EDIT.

## Dividing recorded tracks

### -- Divide Function

You can use this function to add track numbers to multiple tracks that are recorded as one track. This function also lets you mark track numbers. The total number of tracks increases by one and all the tracks following the new division are renumbered.

Eg.: Dividing track 2 into tracks B and C.

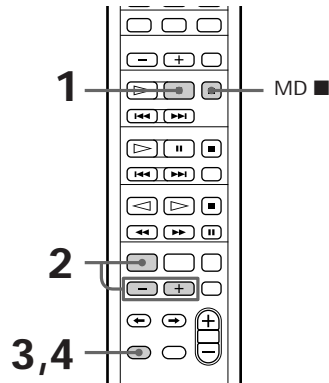
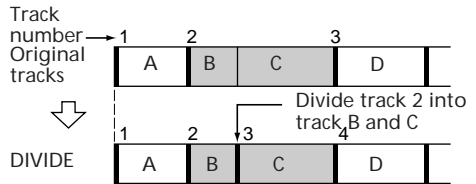

- While playing the MD, press MD II at the point where you want to divide the track. The MD deck pauses.
- Press EDIT then press +/- repeatedly until "Divide ?" appears.

## Dividing recorded tracks (continued)

- 3** Press ENTER/YES.  
 “Rehearsal” and “Position ok ?” appear alternately and the portion to be divided is played repeatedly.
- To shift the division point :  
 While monitoring the sound, press +/- to find the division point. The point moves in increments of 1/86 second (1 frame).

- 4** Press ENTER/YES again when you find the point where you want to divide the track.  
 “Complete” appears for a few seconds and the newly created track begins playing.

### To cancel dividing.

Press EDIT.

### Note

If you divide a labelled track (page 37) into two tracks, only the first track is labelled with the title.

Eg.

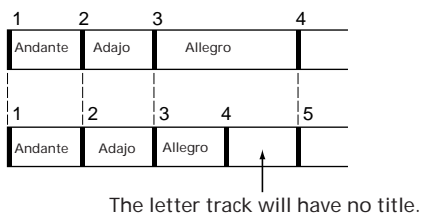

## Combining recorded tracks

### -- Combine Function

You can combine 2 tracks into a single track. The total number of tracks decreases by one and all tracks following the combined ones are renumbered.

Eg.: Combining tracks 1 and 3.

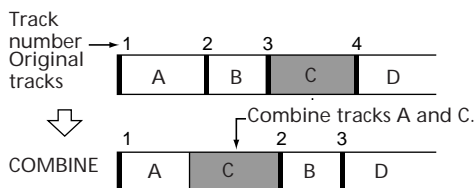

Eg.: Combining tracks 4 and 1.

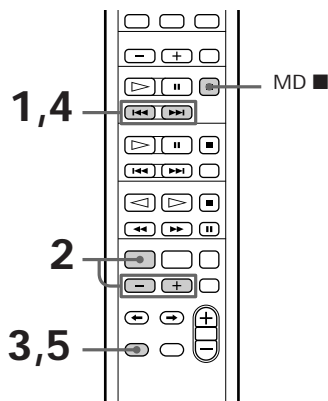
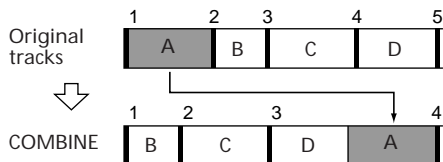

**1** Press MD ►► or ◀◀ repeatedly until the track number you want to be first of two to be combined appears.

For example, to combine tracks 4 and 1, select track 4.

**2** Press EDIT then press +/- repeatedly until "Combine ?" appears.

**3** Press ENTER/YES.

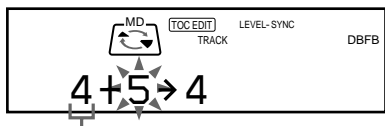

The number of the first track

**4** Press MD ►► or ◀◀ repeatedly until the second track number of the two to be combined appears.

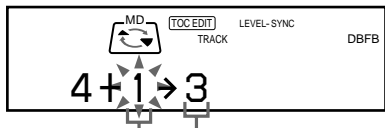

The second track number of the two to be combine      New track number

**5** Press ENTER/YES again to erase the track.  
"Complete" appears for a few seconds and the tracks are combined. Play starts.

## To cancel combining

Press EDIT.

### Notes

- If both of the combined tracks have track titles, the title of the second track is erased.
- \* If "Impossible" appears, the tracks cannot be combined. This happens when you've edited the same track too many times. This is due to a technical limitation of the MD system and is not a mechanical error.

## Undoing the last edit

### -- Undo Function

This function lets you cancel the last edit and restore the contents of the MD to the condition before the edit.

Note, however, that you cannot undo an edit if you do any of the following after the edit :

- Press the ● REC or CD-MD SYNC button on the MD deck.
- Update the TOC by turning the power off or ejecting the MD.
- Disconnect the mains lead.

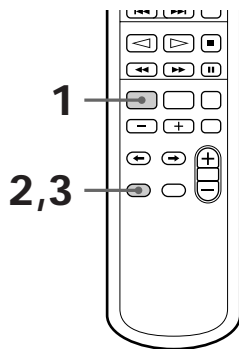

**1** While the deck is stopped with no track number appearing in the display, press EDIT repeatedly until "Undo ?" appears.  
"Undo ?" does not appear if you have not done any previous editing.

## Undoing the last edit (continued)

- 2** Press ENTER/YES.  
One of the following messages appears, depending on the last edit.

| Editing done:               | Message:         |
|-----------------------------|------------------|
| Labeling a track or an MD   | "Name Undo ?"    |
| Erasing a single track      | "Erase Undo ?"   |
| Erasing all tracks on an MD |                  |
| Moving a tracks             | "Move Undo ?"    |
| Dividing a track            | "Divide Undo ?"  |
| Combining tracks            | "Combine Undo ?" |

- 3** Press ENTER/YES again.  
"Complete" appears for a few seconds and the contents of the MD are restored to the condition before the edit.

### To cancel the Undo Function

Press EDIT.

## Adjusting the sound

You can listen to music with stronger bass or more powerful sound.

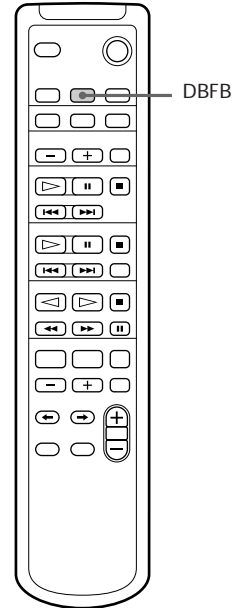

### To reinforce the bass sound

Press DBFB\*.  
"DBFB" appears in the display.  
Press again to cancel DBFB.  
\*DBFB : Dynamic Bass Feedback.

#### Tip

DBFB is factory set to ON.

## Selecting the Preset Equalizer menu

The Preset Equalizer enables you to select the sound characteristic among 5 sound effects according to the music you are listening to.

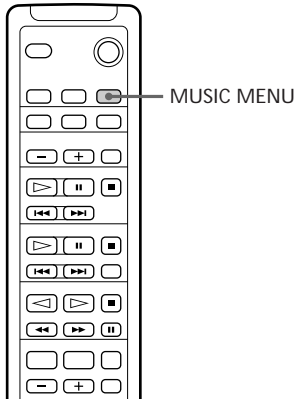

Press MUSIC MENU repeatedly. Each time you press the button, the display changes as follows:

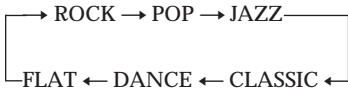

### To cancel the Preset Equalizer

Press MUSIC MENU repeatedly until "FLAT" appears.

#### Tips

- The Preset Equalizer menu is factory set to "ROCK."
- The Preset Equalizer effect is not recorded on an MD or tape.

## Labelling the preset station

### — Station Name

You can label each preset station with up to 10 characters (Station Name). The Station Name appears when you tune in the station.

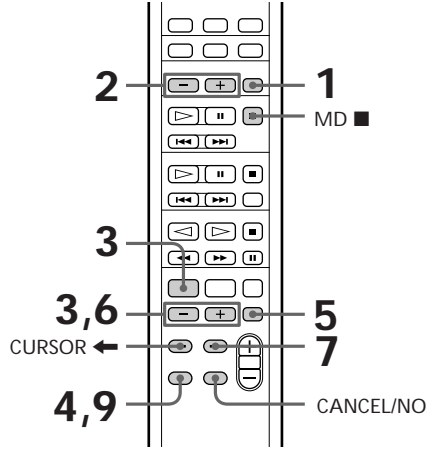

- 1 Press BAND repeatedly until the band you want appears.  
 North American model:  
 FM → AM  
 European model:  
 FM → MW → LW  
 Other models:  
 FM → MW → SW
- 2 Press PRESET + or - repeatedly until the preset number of the station you want to label appears.
- 3 Press EDIT then press + or - repeatedly until "Name in ?" appears.



## Labelling the preset stations (continued)

- 4** Press ENTER/YES.  
The cursor starts flashing.

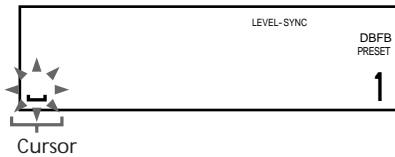

- 5** Press CHARACTER repeatedly until the type of character you want appears.  
Each time you press the button, the display changes as follow:  
A (Upper case) → a (Lower case) → 0 (Numbers) → ! (Symbols)\* →  $\square$  (Space) → A...
- \* You can use the following symbols.

!"#\$%&'()\*+,-./:;<=>?@\_`

- 6** Press +/- repeatedly until the desired character appears.  
To enter a blank space, skip this step.

- 7** Press CURSOR →.  
The character you selected in step 6 stops flashing and the cursor shifts to the right.

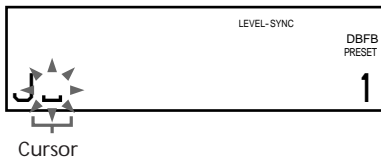

- 8** Repeat steps 5 through 7 to complete the entire title.  
If you enter an incorrect title, press CURSOR ← or → until the character you want to change flashes, then repeat steps 5 through 7. To erase a character, press CANCEL/NO while the character is flashing.

- 9** Press ENTER/YES to complete the labelling procedure.

### To cancel labelling

Press EDIT.

### To check the titles

Press DISPLAY.

Each time you press the button, the display changes as follows:

The station name ↔ Frequency

### To erase the name

Start over from steps 1 through 5 and press CANCEL/NO repeatedly until the label disappears.

---

# Using the Radio Data System (RDS)

(European model only)

## What is the Radio Data System?

Radio Data System (RDS) is a broadcasting service that allows radio stations to send additional information along with the regular programme signal.

### Note

RDS may not work properly if the station you are tuned to is not transmitting the RDS signal properly or if the signal is weak.

\* Not all FM stations provide RDS service, nor do they all provide the same types of services. If you are not familiar with the RDS system, check with your local radio stations for details on RDS services in your area.

---

## Receiving RDS broadcasts

Simply select a station from the FM band.

When you tune in a station that provides RDS services, the station name appears in the display.

---

### To check the RDS information

Each time you press DISPLAY, the display changes as follows:

Station name  
↑  
↓  
Frequency

---

# Falling asleep to music

## — Sleep Timer

You can set the system to turn off after a certain time, so that you can fall asleep to music. You can set the timer in 10 minutes increments.

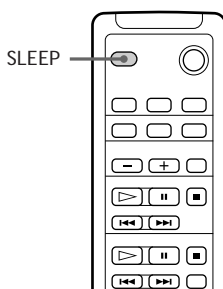

---

Press SLEEP repeatedly to select a desired time.

Each time you press the button, the minute display (the time after which the system turns off) changes as follows:

90min → 80min → 70min ... 10min →  
SLEEP OFF

---

### To check the remaining time

Press SLEEP once.

### To change the turn off time

Select the time you want by pressing SLEEP.

### To cancel the Sleep Timer function

Press SLEEP repeatedly until "SLEEP OFF" appears.

### Tip

You can use the Sleep Timer, when you have not set the clock.

# Waking up to music

## — Wakeup Timer

You can wake up to music at a preset time. Make sure you have set the clock (see page 6).

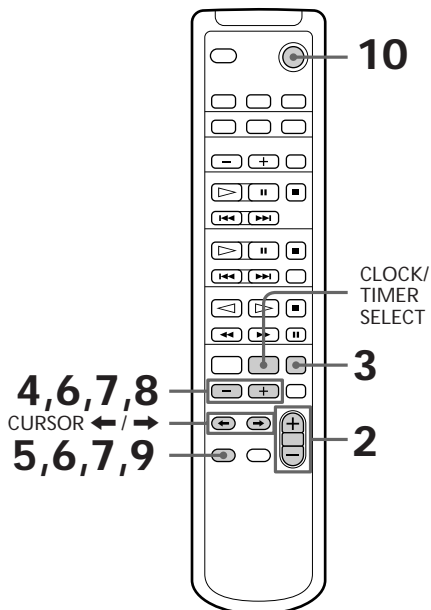

- 1** Prepare the music source you want to play.
  - CD: Insert a CD. To start from a specific track, make a programme (see page 19).
  - MD: Insert an MD. To start from a specific track, make a programme (see page 25).
  - Radio: Tune in a station (see page 7).
  - Tape (the optional tape deck TC-TX313): Insert a tape.
- 2** Press VOL +/- to adjust the sound volume.
- 3** Press CLOCK/TIMER SET.

- 4** Press +/- repeatedly until "DAILY TIMER" appears.
- 5** Press ENTER/YES.  
The hour indication flashes.
- 6** Set the time to start play.  
Press +/- to set the hour, then press ENTER/YES.  
The minute indication flashes.



Press +/- to set the minute, then press ENTER/YES.  
The hour indication flashes again.

- 7** Set the time to stop playback following the above procedure.



- 8** Press +/- repeatedly until the music source you want appears.  
The indication changes as follows:  

```
↳ MD PLAY ↔ CD PLAY ↳  
↳ TAPE PLAY* ↔ TUNER ↳
```
- 9** Press ENTER/YES.  
The start time, followed by the stop time, and the music source appear, then the original display appears.
- 10** Press POWER to turn off the system.



## To change the setting

Start over from Step 1 through Step 5, then press CURSOR ← or → until the time you want to change flashes.

## To check the setting / To use the timer

Press CLOCK/TIMER SELECT repeatedly until "DAILY TIMER" appears. The start time, followed by the stop time, and the sound source appears, then the original display appears.

## To cancel the timer

Press CLOCK/TIMER SELECT repeatedly until "TIMER OFF" appears.

### Tip

When you connect the optional tape deck TC-TX313 to the system, you can activate the deck using the Wake up Timer function without setting the timer on the deck.

### Notes

- You cannot activate wake up timer and recording timer at the same time.
- Do not operate the system from the time the power turns on until the playback starts (about 20 seconds).
- If the power turns on before the preset time, playback starts with your selected music source at the preset time.
- If you use another component (except for the optional tape deck TC-TX313), you must set the timer on both systems to the same time.

# Timer recording radio programmes

To timer record, you must first preset the radio station (see page 7) and set the clock (see page 6).

The MD is automatically labelled with the Station Name, the start time and the stop time of the recording if the station is labeled (see page 45).

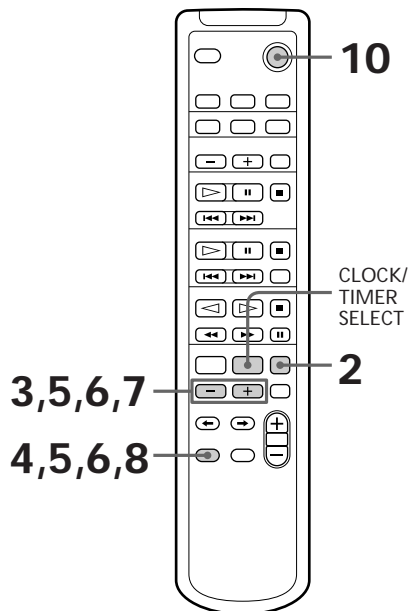

- 1 Tune in the preset radio station (see page 7).
- 2 Press CLOCK/TIMER SET.
- 3 Press +/- repeatedly until "REC TIMER?" appears.
- 4 Press ENTER/YES.  
The hour indication flashes.

## Timer recording radio programmes (continued)

- 
- 5** Set the time to start recording.  
Press +/- to set the hour, then press  
ENTER/YES.  
The minute indication flashes.



Press +/- to set the minute, then press  
ENTER/YES.  
The hour indication flashes again.

- 
- 6** Set the time to stop recording  
following the procedure in step 5.
- 
- 7** Press +/- repeatedly until "TUNER  
to MD."
- 
- 8** Press ENTER/YES.  
The start time, followed by the stop time,  
preset number, and the recording source  
appear, then the original display  
appears.
- 
- 9** Insert a recordable MD.
- 
- 10** Press POWER to turn off the  
system.
- 

## To change the setting

Start over from step 1.

## To check the setting / To use the timer

Press CLOCK/TIMER SELECT repeatedly  
until "REC TIMER" appears. The start time,  
followed by the stop time, the preset number,  
and the recording source appear, then the  
original display appears.

## To cancel the timer

Press CLOCK/TIMER SELECT repeatedly  
until "TIMER OFF" appears.

## To timer-record on tape

You can timer record on a tape with the  
optional tape deck TC-TX313. Select the  
"TUNER to TAPE" in step 7.

## Tip

When you record from the radio, you can mark on  
the MD, the start time, the stop time and the title  
automatically if you have labeled the preset stations  
(see page 45).

## Notes

- You cannot activate wake up timer and recording timer at the same time.
- Do not operate the system from the time the power turns on until the playback starts (about 20 seconds).
- When you record on a blank MD, the first 15 seconds are not recorded.
- If the power is on about 20 seconds before the preset time, the recording will not be made.
- The volume is reduced to minimum during recording.

## Precautions

### On operating voltage

Before operating the system, check that the operating voltage of your system is identical with the voltage of your local power supply.

### On safety

- The system is not disconnected from the mains as long as it is connected to the wall outlet, even if the system itself has been turned off.
- Unplug the system from the wall outlet if it is not to be used for an extended period of time. To disconnect the mains lead, pull it out by the plug. Never pull the cord itself.
- Should any solid object or liquid fall into the system, unplug the system and have it checked by qualified personnel before operating it any further.
- The mains lead must be changed only at a qualified service shop.
- When you connect the mains lead to mains, even through the power is off, the system begins charging for remote and timer functions. Therefore the surface of this unit become warm, this is normal.

### On placement

- Make sure the system fan is on during use. Place the system in a location with adequate air circulation, and do not place a any on the system.
- Place the system in a location with adequate ventilation to prevent heat build up.
- Do not place the system in an inclined position.
- Do not place the system in locations where it is:
  - Extremely hot or cold
  - Dusty or dirty
  - Very humid
  - Subject to vibrations
  - Subject to direct sunlight.

### On installing

When you move the system, remove the CD or MD.

### On operation

- If the system is brought directly from a cold to a warm location, or is placed in a very damp room, moisture may condense on the lens inside the CD player or the MD deck. Should this occur, the system will not operate properly. Remove the CD or MD and leave the system turned on for about an hour until the moisture evaporates.
- When you move the system, take out any discs.

If you have any questions or problems concerning your system, please consult your nearest Sony dealer.

## On the speaker system

This speaker system is not magnetically shielded and the picture on TV sets may become magnetically distorted. In such a case, turn off the power of the TV set once, and after 15 to 30 minutes turn it on again.

If there seems to be no improvement, locate the speaker system further away from the TV set. Also, be sure not to place objects in which magnets are attached or used near the TV set, such as audio racks, TV stands and toys. These may cause magnetic distortion to the picture due to their interaction with the system.

## Notes on MDs

- Do not open the shutter to expose the MD. Close the shutter immediately if the shutter opens.

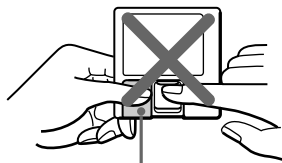

Shutter

- Wipe the disc cartridge with a dry cloth to remove dirt.
- Do not expose the MD to direct sunlight or heat sources such as hot air ducts, nor leave it in a car parked in direct sunlight.

## Notes on CDs

- Before playing, clean the CD with a cleaning cloth. Wipe the CD from the center out.
- Do not use a CD with tape, seals, or paste on it as this may damage the player.
- Do not use solvents such as benzine, thinner, commercially available cleaners, or antistatic spray intended for vinyl LPs.
- Do not expose the CD to direct sunlight or heat sources such as hot air ducts, nor leave it in a car parked in direct sunlight.

## Cleaning the cabinet

Use a soft cloth slightly moistened with mild detergent solution.

---

# System limitations of MDs

The recording system in your MD deck has the limitations described below.

Note, however, that these limitations are due to the inherent nature of the MD recording system itself, not to mechanical causes.

## **“Disc Full” lights up before the MD has reached the maximum recording time (60 or 74 minutes)**

When 255 tracks have been recorded on the MD, “Disc Full” lights up regardless of the total recorded time. More than 255 tracks cannot be recorded on the MD. To continue recording, erase unnecessary tracks or use another recordable MD.

## **“Disc Full” lights up before the maximum number of tracks (255) is reached**

Fluctuations in emphasis within tracks are sometimes interpreted as track intervals, increasing the track count and causing “Disc Full” to light up.

## **The remaining recording time does not increase even after erasing numerous short tracks**

Tracks shorter than 12 seconds are not counted, so erasing them may not increase the recording time.

## **Some tracks cannot be combined with others**

Track combination may become impossible when tracks are shorter than 12 seconds.

## **The total recorded time and the remaining time on the MD do not add up to the maximum recording time (60 or 74 minutes)**

Recording is done in minimum units of 2 seconds each, no matter how short the material. The recorded contents may be shorter than the maximum recording capacity. Disc space may also be reduced by scratches.

## **The sound may drop-out while searching the edited tracks**

Tracks created through editing may exhibit sound dropout during searching because high-speed playback requires time to search for the position on the disc when the tracks are not in order.

## **Track numbers cannot be marked**

When “LEVEL-SYNC” (page 33) lights up in the display window during analogue recording, the track numbers may not be marked at the beginning of the track:

- if the input signal is below a certain fixed level for less than two seconds between tracks.
- if the input signal is below a certain fixed level for more than two seconds in the middle of the track.

## **Guide to the Serial Copy Management System**

Digital audio components, such as CDs, MDs, and DATs let you copy music easily with high quality by processing music as a digital signal.

To protect the copyrighted music programmes, this system uses the Serial Copy Management System that allows you to make only a single copy of a digitally recorded source through digital-to-digital connections.

**You can make only a first generation copy\* through a digital-to-digital connection.**

For example:

- 1 You can make a copy of a commercially available digital sound programme (for example, a CD or MD), but you cannot make a second copy from the first-generation copy.
  - 2 You can make a copy of a digital signal from a digitally recorded analog sound programme (for example, an analog record or a music cassette tape) or from a digital satellite broadcast programme, but you cannot make a second copy.
- \* A first-generation copy means a digital recording of a digital signal made on digital audio equipment. For example, if you record from this system's CD player to the MD deck, you make a first-generation copy.

## **Note**

This copy management system doesn't apply when you make a recording through analog-to-analog connections.

---

## Self-diagnosis Display

This system has the Self-diagnosis display function to let you know if there is a system malfunction. The display shows a code made up of three letters and a message alternately to show you the problem. To solve the problem refer to the following list. If any problem persists, consult your nearest Sony dealer.

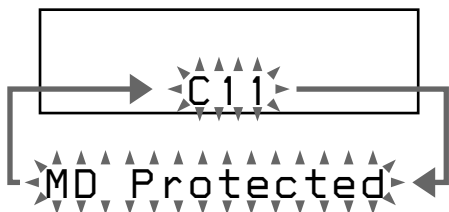

---

### C11/MD Protected

The MD is protected against erasure.

→ Remove the MD and slide the tab to close the slot (page 28)

---

### C13/REC Error

Recording is not possible.

→ Move the system to a stable place and start recording over from the beginning  
The MD is dirty or is scratched or the MD does not meet the standards.

→ Change the MD with another one and start recording over from the beginning.

---

### C13/Disc Error

The MD deck cannot read the disc information correctly.

→ Eject the MD once, then insert it again.

---

### C14/Disc Error

The MD deck cannot read the disc information correctly.

→ Change the MD with another one.

→ Erase all the recorded contents of the MD using the Erase function on page 39.

---

## Troubleshooting

If you have any problem using this system, use the following checklist.

First, check that the mains lead is connected firmly and that the speakers are connected correctly and firmly.

Should any problem persist, consult your nearest Sony dealer.

---

### General

---

There is no sound.

- Turn VOLUME clockwise.
- Make sure the headphones are connected.
- Check the speaker connections.

---

There is severe hum or noise.

- A TV or VCR is placed too close to the system. Move the system away from the TV or VCR.

---

“0:00” flashes in the display.

- A power interruption occurred. Set the clock and timer settings again.

---

The timer does not function.

- Set the clock correctly.

---

The remote does not function.

- There is an obstacle between the remote and the system.
- The remote is not pointing in the direction of the system's sensor.
- The batteries have run down. Replace the batteries.
- Do not place the system in locations where it is near an electric inverter system.

---

The display shows a code made up of three letters and a message

- This system has the Self-Diagnostic function (see “Self-diagnosis Display” ).

---

### Speakers

---

Sound comes from one channel, or the left and right volume are unbalanced.

- Check the speaker connections and speaker placement.

## Troubleshooting (continued)

### CD Player

---

The CD tray does not close.

- The CD is not placed properly.
- 

The CD will not eject.

- The CD has tape, seals, or paste on it.
- 

The CD will not play.

- Press CD  $\cong$  to check the CD placed. When you listening to the radio and the disc tray is open, the CD indicator is lit red, then the CD is not placed.
  - The CD is dirty. Clean the CD with a cleaning cloth.
  - The face of the CD is scratched. Exchange the CD.
  - The CD is inserted label side down.
  - Moisture condensation has built up. Remove the CD and leave the system turned on for about 2 hours until the moisture evaporates.
- 

Play does not start from the first track.

- The player is in programme or shuffle mode. Press PLAY MODE repeatedly until "SHUFFLE" or "PGM" disappears.
- 

"OVER" is displayed.

- You have reached the end of the CD. Press CD  $\blacktriangleleft\blacktriangleleft$  to return to the beginning of the CD.
- 

### MD Deck

---

The controls do not work.

- The MD is dirty or scratched. ("Disc Error" appears.) Replace the MD with a new one.
- 

The MD will not play.

- Moisture condensation has built up. Remove the MD and leave the system turned on for several hours until the moisture evaporates.
  - Insert the MD in the direction of the arrow.
  - Nothing is recorded on the MD.
- 

Recording is not possible.

- The MD is protected against erasure. ("MD Protected" appears.) Slide the tab to close the slot (see page 28).
- 

- Connect the sound source properly.
  - A pre-recorded MD is in the deck. Replace the disc with a recordable MD.
  - Replace the disc with a recordable MD that has sufficient time remaining or erase unnecessary tracks.
  - The mains lead was unplugged or a power interruption occurred during recording. Start recording over from the beginning.
- 

"END" is displayed.

- You have reached the end of the MD. Press MD  $\blacktriangleleft\blacktriangleleft$  to return to the beginning of the MD.
- 

"Level Over" appears during analogue recording.

A strong signal was input during recording in the TAPE function. When the sound is distorted, reduce the recording level, then re-record. If distortion may occurs:

- 1 Stop play or turn off the power of the other component connected to the TAPE input.

"Level Over" disappear.

- 2 Press EDIT on the remote during recording or pause.
- 3 Press +/- on the remote. "Attenuate ?" appears.
- 4 Press ENTER/YES on the remote. "Attenuate ON ?" appears.
- 5 Press ENTER/YES again. "ATT" appears.

- 6 Turn on the power of the other component connected to the TAPE input and continue recording or start recording over from the beginning.

To cancel the setting, select "Attenuate OFF ?" in step 4.

---

### Tuner

---

Severe hum or noise ("TUNED" or "STEREO" flashes in the display).

- Adjust the aerial.
- The signal strength is too weak. Connect an external aerial.
- Make sure the aerial is connected properly.
- You cannot fold or roll up the aerial.
- The FM aerial is split in two. Repair or replace with a new one.
- The AM aerial is detached from the stand.

---

A stereo FM programme is not received in stereo.

- Press STEREO/MONO so “STEREO” appears.
- 

**If other problems not described above occur, reset the system as follows:**

- 1 Unplug the mains lead.
- 2 Hold down POWER, then plug the mains lead into the wall outlet again.

The system is reset to the factory settings. All the settings you made, such as the preset stations, clock, and timer are cleared. You should set them again.

## Messages

One of the following messages may appear or flash in the display window during operation.

---

### MD

#### Auto cut

The MD deck is pausing the recording because silence continued for 30 seconds or more during digital recording.

---

#### Blank Disc

The inserted recordable MD is new or all tracks on the MD have been erased.

---

#### Cannot Copy

You cannot make a digital recording (see “Guide to the Serial Copy Management System” on page 52).

---

#### Cannot edit

You tried to edit in Programme or Shuffle Play mode.

---

#### Cannot REC

A pre-recorded MD is in the deck.

---

#### Disc Error

The inserted MD is damaged or does not contain a TOC.

---

#### Impossible

You tried to combine from the first track on an MD, which is not possible. You tried to divide the first or end of the track.

---

---

### Level Over

A strong signal was input during analog recording in the TAPE function. Reduce the recording level following the procedure. (see “Troubleshooting” on page 54).

---

### MD Disc Full

There is no time remaining on the disc (see “System Limitations of MDs” on page 52).

---

### MD NO DISC

There is no MD in the deck.

---

### MD Protected

The inserted MD is protected against erasure.

---

### Name Full

There is no more space to store track or disc titles.

---

### NEW

The MD deck stands by for recording on a brand new MD or from the last recorded portion.

---

### No Name

The inserted MD has a track numbers but no disc titles.

---

### No Track

The inserted MD has a disc title but no tracks.

---

### – OVER –

You have reached the end of the last track during high-speed search.

---

### Push STOP!

You pressed PLAY MODE during play.

---

### Smart Space

The signal was input again after silence continued for 30 seconds or less during digital recording.

---

### TOC Reading

The MD deck is reading the TOC information of the MD.

---

### TOC Writing

The MD deck is writing the information of recorded or edited contents.

---

### Track End

You have reached the end of the MD while adjusting the division point during Divide Function.

---

## Troubleshooting (continued)

### TUNER

---

#### Name Full

The system has stored the maximum number of characters to be input.

---

### CD

---

#### Name Full

There is no more space to store track or disc titles.

---

### OVER

---

You have reached the end of the CD while pressing the ►► button during pause.

---

---

## Specifications

### Amplifier section

Canadian model:

Continuous RMS power output  
20 + 20 watts  
(6 ohms at 1 kHz, 1% THD, 120V)(Rated)  
25 + 25 watts  
(6 ohms at 1 kHz, 10% THD, 120V)(Reference)

European model:

DIN power output (Rated)  
25 + 25 watts  
(6 ohms at 1 kHz, DIN, 230V)  
Continuous RMS power output (Reference)  
30 + 30 watts  
(6 ohms at 1 kHz, 10% THD, 230V)  
Music power output (Reference)  
50 + 50 watts

Other models:

DIN power output (Rated)  
20 + 20 watts  
(6 ohms at 1 kHz, DIN, 240V)  
18 + 18 watts  
(6 ohms at 1 kHz, DIN, 220V)  
Continuous RMS power output (Reference)  
25 + 25 watts  
(6 ohms at 1 kHz, 10% THD, 240V)  
23 + 23 watts  
(6 ohms at 1 kHz, 10% THD, 220V)

Peak music power output 400 watts

Inputs TAPE IN (phono jacks):  
voltage 250 mV/125 mV,  
impedance 47 kilohms

Outputs TAPE OUT (phono jacks):  
voltage 250 mV  
impedance 1 kilohms

PHONES (Stereo minijack):  
accepts headphones of 8 ohms or more.  
SPEAKER:  
accepts impedance of 6 to 16 ohms.

### CD player section

System Compact disc and digital audio system  
Laser Semiconductor laser  
( $\lambda=780$  nm)  
Emission duration:  
continuous



|                    |   |                        |  |
|--------------------|---|------------------------|--|
| Laser output       | Max. 44.6 $\mu$ W*<br>*This output is the value measured at a distance of 200 mm from the objective lens surface on the Optical Pick-up Block with a 7 mm aperture. | SW:                    | 5.95 – 17.90 MHz<br>(with the interval set at 5 kHz) |
| Frequency response | 2 Hz – 20 kHz   | Aerial                 | AM loop aerial<br>External aerial terminals          |
|                    |   | Intermediate frequency | 450kHz   |

## MD deck section

|                    |   |
|--------------------|---|
| System             | MiniDisc digital audio system   |
| Laser              | Semiconductor laser ( $\lambda=780$ nm)<br>Emission duration: continuous  |
| Laser output       | Max. 44.6 $\mu$ W*<br>*This output is the value measured at a distance of 200 mm from the objective lens surface on the Optical Pick-up Block with a 7 mm aperture. |
| Recording time     | 74 minutes max. (using MDW-74)  |
| Sampling frequency | 44.1 kHz  |
| Frequency response | 5 Hz to 20 kHz  |

## Tuner section

FM stereo, FM/AM superheterodyne tuner

## FM tuner section

|                        |                                   |
|------------------------|-----------------------------------|
| Tuning range           | 87.5 – 108.0 MHz<br>(50 kHz step) |
| Aerial                 | FM lead aerial                    |
| Aerial terminals       | 75 ohms unbalanced                |
| Intermediate frequency | 10.7 MHz                          |

## AM tuner section

|                       |   |
|-----------------------|---|
| Tuning range          |   |
| North American model: |   |
| AM:                   | 530 – 1,710 kHz<br>(with the interval set at 10 kHz)<br>531 – 1,710 kHz<br>(with the interval set at 9 kHz) |
| European model:       |   |
| MW:                   | 522 – 1,611 kHz<br>(with the interval set at 9 kHz)   |
| LW:                   | 144 – 288 kHz<br>(with the interval set at 3 kHz)   |
| Other models:         |   |
| MW:                   | 531 – 1,602 kHz<br>(with the interval set at 9 kHz)<br>530 – 1,710 kHz<br>(with the interval set at 10 kHz) |

## Speaker

### SS-MD313

|                |                             |
|----------------|-----------------------------|
| Speaker system | 2-way, bass-reflex type     |
| Speaker units  |                             |
| Woofers:       | 13 cm dia., cone type       |
| Tweeters:      | 2.5 cm dia., balanced drive |

## General

|                                |  |
|--------------------------------|--|
| Power requirements             |  |
| North American model:          | 120 V AC, 60 Hz                            |
| European model:                | 220 – 230 V AC,<br>50/60 Hz                |
| Other models:                  | 110 - 120 V or 220 - 240 V<br>AC, 50/60 Hz |
| Power consumption              |  |
| North American model:          | 70 watts                                   |
| Other models:                  | 80 watts                                   |
| Dimensions                     |  |
| Amplifier/Tuner/MD/CD section: |  |

|          |  |
|----------|--|
| Approx.  | 215 × 150 × 320 mm (8 1/4 × 6 × 12 5/8 in) (w/h/d) incl. projecting parts and controls             |
| Speaker: | Approx. 170 × 275 × 240 mm (6 3/4 × 10 7/8 × 9 1/2 in) (w/h/d) incl. projecting parts and controls |

## Mass

|                                |  |
|--------------------------------|--|
| Amplifier/Tuner/MD/CD section: | Approx. 5.5 kg (12 lb8oz.)                 |
| Speakers:                      | Approx. 2.8 kg (6 lb 3oz.) net per speaker |

|                      |  |
|----------------------|--|
| Supplied accessories | Remote RM-MD313 (1)<br>AA (R6) batteries (2)<br>AM loop aerial (1)<br>FM lead aerial (1) |
|----------------------|--|

Design and specifications are subject to change without notice.

---

# Index

## A

- Adjusting
  - the sound 44
  - the volume 11
- Aerials 4, 9
- After
  - editing 36
  - recording 28
- AMS 11, 14
- Analogue recording 28
- Automatic Source Selection 12, 15, 16
- Auto cut 34

## B

- Batteries 5
- Before
  - editing 36
  - recording 28

## C

- CD player 11, 18
- CD-MD Synchro Recording 12, 29
- Clock setting 6
- Combine Function 42
- Connecting. *See* Hooking up

## D

- DBFB 44
- Digital recording 28
- Display 21, 27
- Divide Function 41

## E, F, G

- Erase Function 38
- Erasing
  - a portion of a track 40
  - a single track 38
  - all tracks on an MD 39

## H, I, J, K

- Hooking up
  - optional components 9
  - the aerials 4, 5, 10
  - the power 5
  - the speaker 4

## L

- Labelling
  - a CD 22
  - an MD 37
  - a preset station 45
- Level Sync Recording 33
- Loop 21

## M

- MD deck 52
- MD messages 55
- Move function 40

## N

- Normal Play 11

## O

- One Touch Play 12, 15, 16

## P, Q

- Playing
  - a CD 11
  - an MD 14
  - a preset radio station 15
  - tracks in random order (Shuffle Play) 19, 24
  - tracks in the desired order (Programme Play) 19, 25
  - tracks repeatedly (Repeat Play) 18, 24
- Preset equalizer menu 45
- Presetting radio stations 7
- Preset tuning 15
- Programme Play 19, 25
- Protecting recordings 28

## R

- Radio stations
  - presetting 7
  - tuning in 15
- RDS 47
- Recording
  - a CD 12, 29
  - a radio programme 17
  - on an MD 28
  - timer recording 49
- Repeat Play 18, 24
- Resetting the system 55

## S

- Saving recordings 28
- Self-diagnosis display 53
- Setting the time 6
- Serial copy management system 52
- Shuffle Play 19, 24
- Sleep Timer 47
- Smart space 34
- Sound adjustment 44
- Speakers 4
- Station Name 45
- System limitations 52

## T, U, V

- Time Machine Recording 31
- Timer
  - falling asleep to music 47
  - timer recording 49
  - waking up to music 48
- Track numbers 33
- Track marking 33
- Troubleshooting 53
- Tuner 7, 15
- Undo 43

## W, X, Y, Z

- Wake-up timer 48