

# *Compact Hi-Fi Stereo System*

---

Operating Instructions



*LBT-V4800R*

## WARNING

To prevent fire or shock hazard, do not expose the unit to rain or moisture.

To avoid electrical shock, do not open the cabinet. Refer servicing to qualified personnel only.

Do not install the appliance in a confined space, such as a bookcase or built-in cabinet.

Laser component in this product is capable of emitting radiation exceeding the limit for Class 1.



This appliance is classified as a CLASS 1 LASER product. The CLASS 1 LASER PRODUCT MARKING is located on the rear exterior.

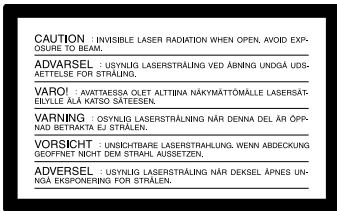

This caution label is located inside the unit.



This stereo system is equipped with the Dolby\* B-type noise reduction system.

\* Dolby noise reduction manufactured under license from Dolby Laboratories Licensing Corporation. "DOLBY" and the double-D symbol  are trademarks of the Dolby Laboratories Licensing Corporation.

## This system can play the following discs:

	VIDEO CDs	Audio CDs
Disc logo		
Contents	Audio + Video (moving pictures)	Audio
Disc size	12 cm/8 cm	12 cm/8 cm
Play time	74 min./20 min.	74 min./20 min.

### Note on VIDEO CDs

This system conforms to VIDEO CDs without PBC\* functions (Ver. 1.1) and VIDEO CDs with PBC\* functions (Ver. 2.0) of VIDEO CD standards. You can enjoy two kinds of playback according to the disc type.

Disc type	You can
VIDEO CDs without PBC functions (Ver. 1.1 discs)	Enjoy video playback (moving pictures) as well as audio CDs.
VIDEO CDs with PBC functions (Ver. 2.0 discs)	Play interactive software using menu screens displayed on the TV screen (menu playback), in addition to the video playback function of VIDEO CDs without PBC functions. Moreover, you can play high or standard quality still picture.

\* PBC = PlayBack Control

---

# Table of Contents

---

## Getting Started

Step 1: Hooking up the system .....	4
Step 2: Setting the time .....	6
Step 3: Presetting radio stations .....	7
Connecting optional AV components .....	8

## Basic Operations

Playing a VIDEO CD .....	10
Playing a CD .....	12
Recording a CD/VIDEO CD .....	14
Listening to the radio .....	15
Recording from the radio .....	16
Playing a tape .....	17
Recording from a tape .....	19
Singing along: Karaoke .....	20

## The VIDEO CD/CD Player

Playing a VIDEO CD with PBC functions (Ver 2.0) .....	22
Using the CD display .....	23
Using the on-screen display .....	24
Locating a specific part of a disc .....	26
Playing a VIDEO CD from where it was last stopped .....	30
Reducing distortion of the picture with advanced DNR .....	31
Setting the sharpness .....	32
Adding trails to moving pictures .....	32
Playing CD tracks repeatedly .....	33
Playing CD tracks in random order .....	33
Programming CD tracks .....	34
Playing CDs without interruption .....	36

## The Tape Deck

Recording on a tape manually .....	37
Recording CDs by specifying the track order .....	38

## DJ Mix

Looping part of a CD .....	40
Flashing part of a CD .....	40
Waving the equalizer .....	41

## Sound Adjustment

Adjusting the sound .....	42
Selecting the audio emphasis .....	43
Adjusting the audio emphasis .....	44
Making a personal audio emphasis file .....	45

## Other Features

Mixing and recording sounds .....	46
Falling asleep to music .....	47
Waking up to music .....	47
Timer-recording radio programs .....	49

## Additional Information

Precautions .....	50
Troubleshooting .....	51
Specifications .....	53
Glossary .....	55
Index .....	Back cover

## Step 1: Hooking up the system

Follow steps **1** through **7** to hook up your system using the supplied cords and accessories.

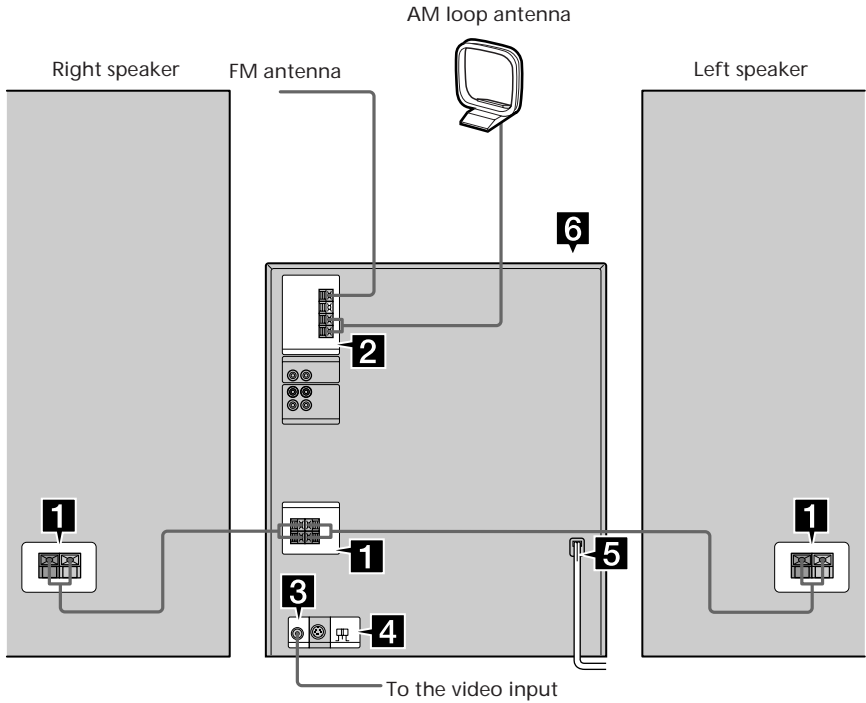

### **1** Connect the speakers.

- 1 Connect the speaker cords to SPEAKER jacks. Keep the speaker cords away from the antennas to prevent noise.

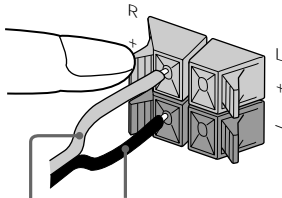

Copper (+) Silver (-)

- 2 Insert only the stripped portion of the cord. Inserting the vinyl portion will interfere with the speaker connection and no sound will come from the speaker.

### **2** Connect the FM/AM antennas.

- Set up the AM loop antenna, then connect it.

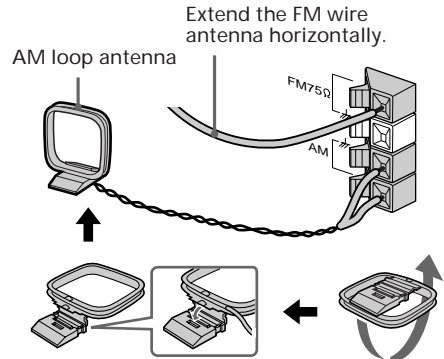

- 
- 3** Connect the video input jack of your TV to the VIDEO OUT jack with the supplied video connecting cable.

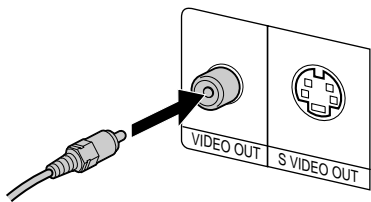

#### When using a TV

Turn on the TV and select the video input so you can view the pictures from this system.

#### Tip

For even higher quality video images, you can use an optional S VIDEO cord to connect the S VIDEO input jack on your TV to the S VIDEO OUT jack.

- 
- 4** Set SYSTEM SELECT (color system) to the appropriate position (PAL or NTSC), according to your TV.

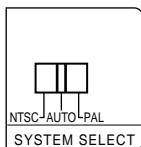

#### If your TV automatically changes the color system according to the input signal:

The factory setting (AUTO) automatically changes the color system of the video output according to the color system of the current VIDEO CD. If you turn off the system, the color system will be set to NTSC automatically when you turn on the system again.

#### If the color system of your TV is NTSC:

Set SYSTEM SELECT to NTSC.

Picture recorded in the PAL color system will be stretched vertically and will be displayed with the upper and lower parts of the picture cut off.

#### If the color system of your TV is PAL:

Set SYSTEM SELECT to PAL.

Picture recorded in the NTSC color system will be stretched horizontally and will be displayed with the upper and lower parts of the screen masked in black.

#### Note

Be sure to turn off the system before changing the SYSTEM SELECT setting.

- 
- 5** Connect the power cord to a wall outlet.

The demonstration appears in the display.

- 
- 6** Deactivate the demonstration mode by pressing DISPLAY/DEMO while the system is off.
- 

#### Inserting two size AA (R6) batteries into the remote

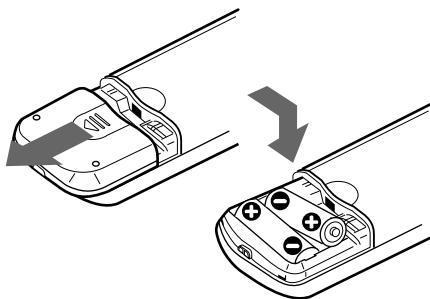

## Step 1: Hooking up the system (continued)

### Using the remote

You can use the shaded buttons shown below to operate Sony TV.

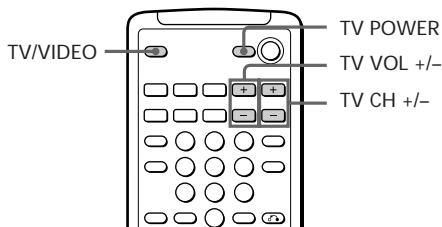

To	Press on the remote
Turn the TV on or off	TV POWER.
Switch the TV's video input	TV/VIDEO.
Change the TV channels	TV CH +/-.
Adjust the volume of the TV speaker(s)	TV VOL +/-.

### Tips

- With normal use, the batteries should last for about six months. When the remote no longer operates the system, replace both batteries with new ones.
- When you set the time, the demonstration is deactivated.

To activate the demonstration again, press DISPLAY/DEMO while the system is off.

### Note

If you do not use the remote for a long period of time, remove the batteries to avoid possible damage from battery leakage.

### When carrying this system

Do the following to protect the CD mechanism.

- 1 Press FUNCTION repeatedly until "CD" appears in the display.
- 2 Hold down PLAY MODE and press POWER so that "LOCK" appears in the display.

## Step 2: Setting the time

You must set the time before using the timer functions.

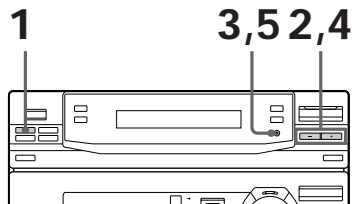

- 1 Press /CLOCK SET.  
The hour indication flashes.



- 2 Press TUNING +/- to set the hour.  
The clock uses the 12-hour system.

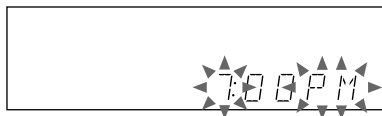

- 3 Press ENTER/NEXT.  
The minutes indication flashes.

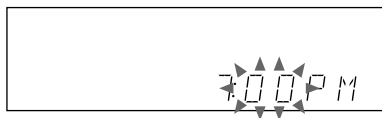

- 4 Press TUNING +/- to set the minutes.

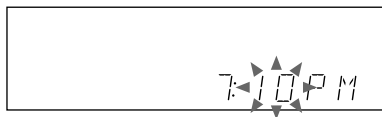

- 5 Press ENTER/NEXT.  
The clock starts.

# Step 3: Presetting radio stations

You can preset up to 30 stations, 20 for FM and 10 for AM.

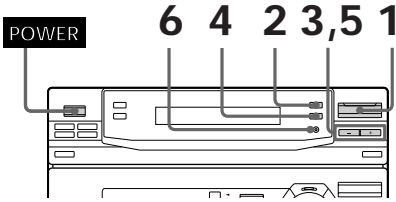

**1** Press TUNER/BAND repeatedly until the band you want appears in the display.

Each time you press this button, the band changes as follows:  
FM ↔ AM

**2** Press TUNING MODE repeatedly until “AUTO” appears in the display.

**3** Press TUNING +/-.

The frequency indication changes and scanning stops when the system tunes in a station. “TUNED” and “STEREO” (for a stereo program) appear.

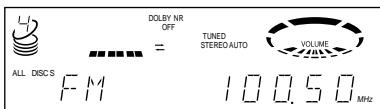

**4** Press TUNER MEMORY.

A preset number flashes in the display.

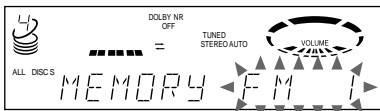

**5** Press TUNING +/- to select the preset number you want.

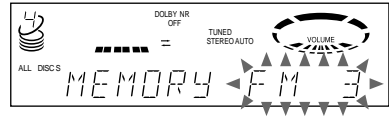

**6** Press ENTER/NEXT.  
The station is stored.

**7** Repeat steps 1 through 6 to store other stations.

## To tune in a station with a weak signal

Press TUNING MODE repeatedly until “MANUAL” appears in step 2, then press TUNING +/- to tune in the station.

## To change the preset number

Start over from step 1.

## To change the AM tuning interval

The AM tuning interval is factory-preset to 9 kHz. To change the AM tuning interval to 10 kHz, press TUNER/BAND repeatedly until “AM” appears first, then turn off the system. While holding down ENTER/NEXT, turn the system back on. When you change the interval, the AM preset stations will be erased. To reset the interval, repeat the same procedure.

### Note

The preset stations are canceled when you disconnect the power cord or if a power failure occurs for half a day.

# Connecting optional AV components

To enhance your system, you can connect optional components. Refer to the instructions included with each component for details.

## Connecting audio components

### Connecting a turntable

Be sure to match the color of the plugs and the connectors. To listen to the sound from the connected turntable, press FUNCTION repeatedly until "PHONO" appears.

To the audio output of the turntable

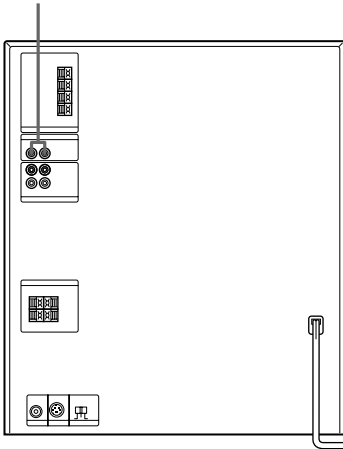

### Note

Using the turntable at high volume may cause distortion or howling. This is often caused by the bass sound from the speakers. The bass sound may be picked up by the needle of the turntable, and produce the distortion or howling. To avoid this, do the following:

- 1 Keep some distance between the speakers and the turntable.
- 2 Stop using the surround effect.
- 3 Install the speakers or the turntable on a firm and stable surface.
- 4 Press SUPER WOOFER repeatedly until the indicator on this button goes off.

## Connecting a VCR

Be sure to match the color of the plugs and the connectors. To listen to the sound of the connected VCR, press FUNCTION repeatedly until "VIDEO" appears.

By connecting the audio output jacks of your VCR to the VIDEO (AUDIO) IN jacks, you can enjoy video playback in powerful stereo sound.

Moreover, if you connect the video/audio input on the VCR to the VIDEO (AUDIO) OUT and VIDEO OUT (or S VIDEO OUT) jacks, you can record the audio and video signals from a VIDEO CD onto video tape.

To the audio outputs of the VCR using an optional audio cable

To the audio inputs of the VCR using an optional audio cable

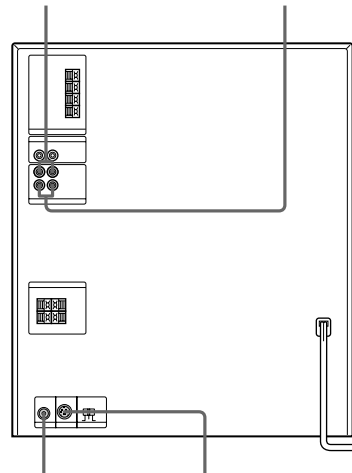

To the video input of the VCR using the video cable

To the S VIDEO input of the VCR using an optional S VIDEO cable



# Connecting outdoor antennas

Connect an outdoor antenna to improve the reception.

## FM antenna

Connect an optional FM outdoor antenna. You can also use the TV antenna instead.

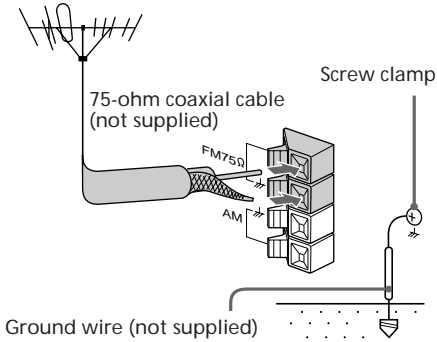

## AM antenna

Connect a 6 to 15 meter (20 to 50 feet) insulated wire to the AM antenna terminal. Leave the supplied AM loop antenna connected.

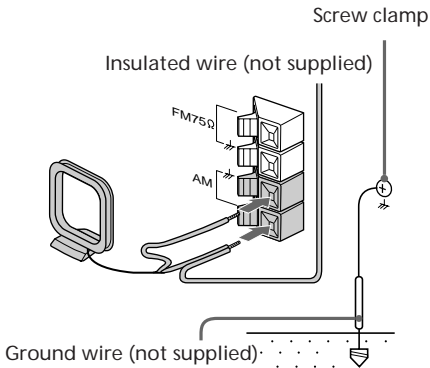

## Important

If you connect an outdoor antenna, connect a ground wire to the  $\text{h}$  terminal with the screw clamp. To prevent a gas explosion, do not connect the ground wire to a gas pipe.

## Playing a VIDEO CD

You can play both VIDEO CDs without PBC functions (Ver 1.1) and VIDEO CDs with PBC functions (Ver 2.0).

You can enjoy two kinds of playback according to the disc type.

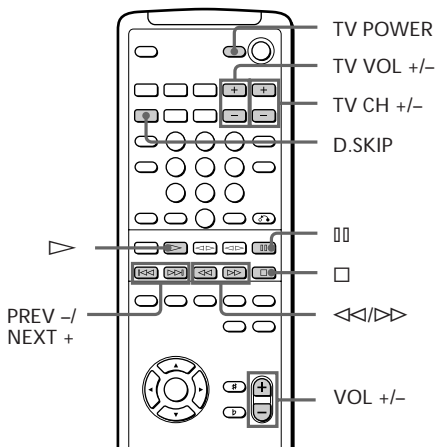
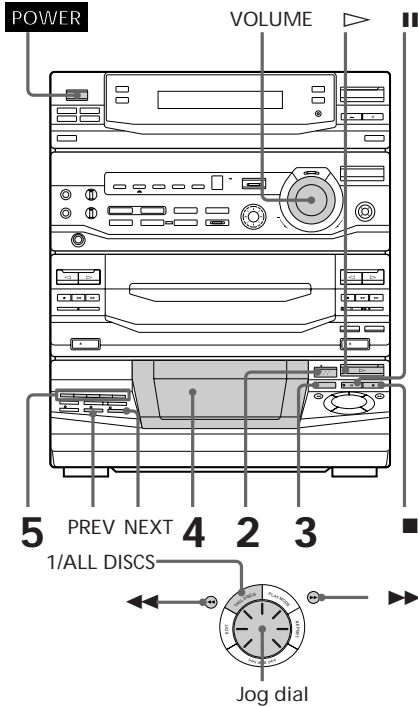

**1** Turn on your TV and select the video input.  
Refer to the operating instructions supplied with your TV if you need help.

**2** Press **▲ OPEN** and place a VIDEO CD on the disc tray.  
If the disc is not placed properly it will not be recognized.

With the label side up. When you play a VIDEO CD single, place it on the inner circle of the tray.

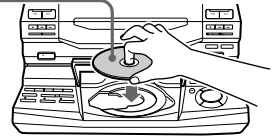

**3** Press DISC SKIP to place up to four more VIDEO CDs on the tray.  
The disc tray rotates so you can insert other CDs.

**4** Close the front cover.

**5** Press one of the DIRECT PLAY buttons.  
Playback starts.  
If you press **▷**, playback starts from the VIDEO CD in the playing position.

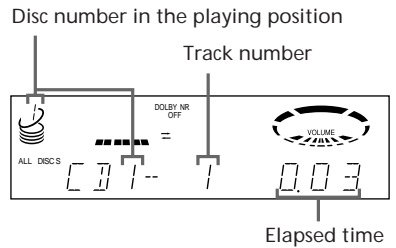

To	Do this
Stop playback	Press <b>■</b> (or <b>□</b> on the remote).
Pause	Press <b>⏸</b> (or <b>⏹</b> on the remote)* <sup>1</sup> . Press again to resume playback.
Select a track or scene	Press <b>NEXT</b> (or <b>NEXT +</b> on the remote) to go forward, or <b>PREV</b> (or <b>PREV -</b> on the remote) to go back. Or during playback or pause, turn the jog dial clockwise (to go forward) or counterclockwise (to go back) and release it when you reach the desired track* <sup>2</sup> .
Find a point in a track or scene* <sup>2</sup>	Press and hold <b>◀◀</b> or <b>▶▶</b> (or <b>&lt;&lt;/&gt;&gt;</b> on the remote) during playback, and release at the desired point.
Select a VIDEO CD	Press one of the <b>DIRECT PLAY</b> buttons (or <b>D.SKIP</b> on the remote).
Play only the VIDEO CD you have selected	Press <b>1/ALL DISCS</b> repeatedly until "1 DISC" appears.
Play all VIDEO CDs* <sup>3</sup>	Press <b>1/ALL DISCS</b> repeatedly until "ALL DISCS" appears.
Remove or change the VIDEO CDs	Press <b>▲ OPEN</b> .
Adjust the volume	Turn <b>VOLUME</b> (or press <b>VOL +/-</b> on the remote).

**Tips**

- Pressing **▷** while the system is off automatically turns on the system and starts VIDEO CD playback if there is a VIDEO CD on the tray (One Touch Play).
- You can switch from another source to the VIDEO CD player and start playing a VIDEO CD just by pressing **▷** or one of the **DIRECT PLAY** buttons (Automatic Source Selection).
- If there is no VIDEO CD in the player, "NO DISC" appears in the display.
- You can change the VIDEO CD in the loading position during playback.

\*<sup>1</sup> There may be some disturbance in the video image.  
 \*<sup>2</sup> Only for VIDEO CDs without PBC functions (Ver 1.1).  
 \*<sup>3</sup> This function cannot be used during menu playback of a VIDEO CD with the PBC functions (Ver 2.0).

# Playing a CD

## — Normal Play

You can play up to five CDs in a row.

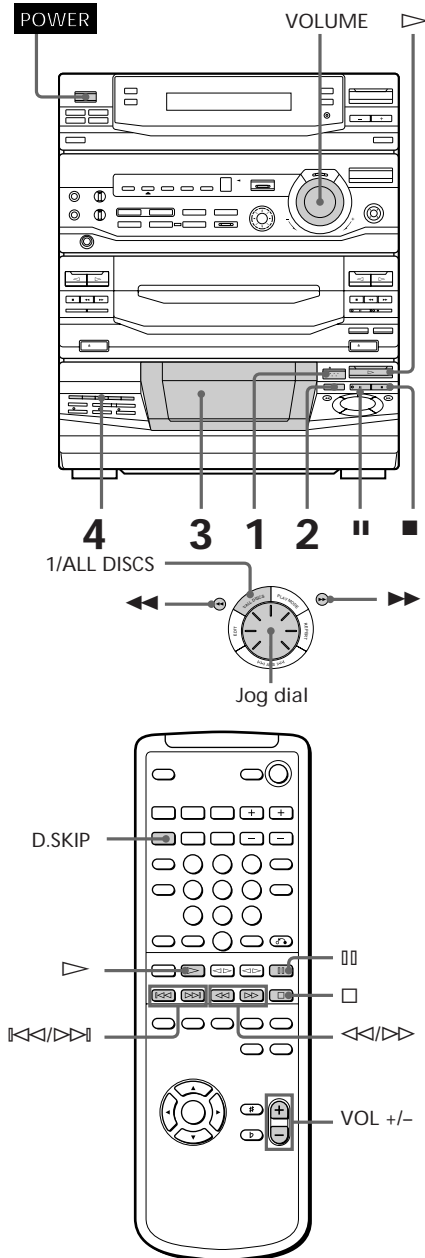

- 1 Press **▲ OPEN** and place a CD on the disc tray.  
If the disc is not placed properly it will not be recognized.

With the label side up. When you play a CD single, place it on the inner circle of the tray.

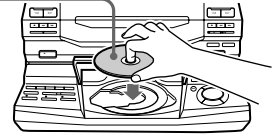

- 2 Press **DISC SKIP** to place up to four more CDs on the tray.  
The disc tray rotates so you can insert other CDs.

- 3 Close the front cover.

- 4 Press one of the **DIRECT PLAY** buttons.  
Playback starts.  
If you press **▶**, playback starts from the CD in the playing position.

Disc number in the playing position  
Track number

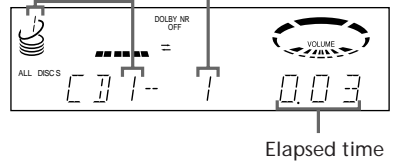

To	Do this
Stop playback	Press ■ (or □ on the remote).
Pause	Press ■■ (or □□ on the remote). Press again to resume playback.
Select a track	During playback or pause, turn the jog dial clockwise (to go forward) or counterclockwise (to go backward) and release it when you reach the desired track. Or press ▷>  (to go forward) or  <<◁ (to go backward) on the remote.
Find a point in a track	Press and hold ►► or ◀◀ (or ◀◁/▷▷ on the remote) during playback, and release at the desired point.
Select a CD	Press one of the DIRECT PLAY buttons (or D.SKIP on the remote).
Play only the CD you have selected	Press 1/ALL DISCS repeatedly until "1 DISC" appears.
Play all CDs	Press 1/ALL DISCS repeatedly until "ALL DISCS" appears.
Remove or change the CDs	Press ▲ OPEN.
Adjust the volume	Turn VOLUME (or press VOL +/- on the remote).

### Tips

- Pressing ▷ while the system is off automatically turns on the system and starts CD playback if there is a CD on the tray (One Touch Play).
- You can switch from another source to the CD player and start playing a CD just by pressing ▷ or one of the DIRECT PLAY buttons (Automatic Source Selection).
- If there is no CD in the player, "NO DISC" appears in the display.
- You can change the CD in the loading position during playback.

# Recording a CD/VIDEO CD

## — CD Synchro Recording

The CD SYNC button lets you record audio sources from a CD/VIDEO CD to a tape easily. You can use TYPE I (normal) or TYPE II (CrO<sub>2</sub>) tapes.

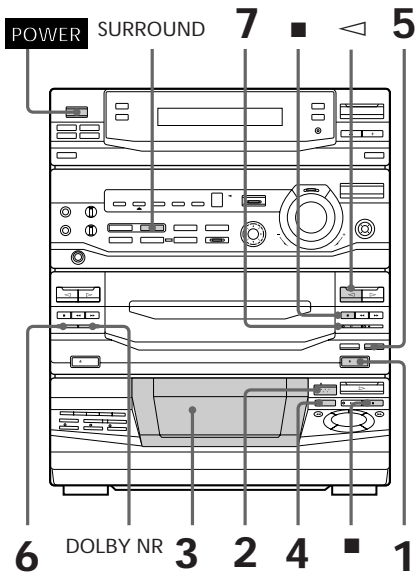

- 1 Press ▲ EJECT and insert a blank tape into deck B.

With the side you want to record on facing forward

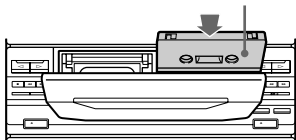

- 2 Press ▲ OPEN and place a CD.

With the label side up. When you play a CD single, place it on the inner circle of the tray.

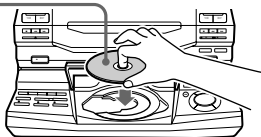

- 3 Close the front cover.
- 4 Press DISC SKIP repeatedly until the disc number you want to record appears in the playing position indicator.
- 5 Press CD SYNC.  
Deck B stands by for recording and the CD player stands by for playback, and the indicator on the ▷ button (for the front side) lights up green.
- 6 Press DIRECTION repeatedly to select ⇌ to record on one side or ↔ (or RELAY) to record on both sides.
- 7 Press || on deck B.  
Recording starts.

### To stop recording

Press ■ on deck B or on the CD player.

### Tips

- If you want to record on the reverse side, press ◀ so the indicator on the ◀ button (for the reverse side) lights up green.
- When you record on both sides, be sure to start from the front side. If you start from the reverse side, recording stops at the end of the reverse side.
- When you want to reduce the hiss noise in low-level high-frequency signals, press DOLBY NR before step 7 so "DOLBY NR B" appears in the display.
- To record with the surround effect, press SURROUND so "SUR (■■■■)" appears in the display.  
The equalizer settings will not be recorded.

### Notes

- You cannot listen to other sources while recording.
- You cannot record from a VIDEO CD with PBC functions (Ver 2.0).

# Listening to the radio

## — Preset Tuning

Before using this function, preset radio stations in the tuner's memory (see "Step 3: Presetting radio stations").

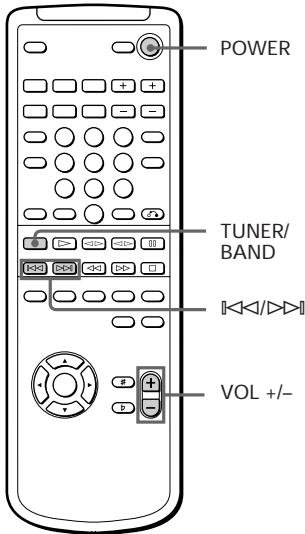
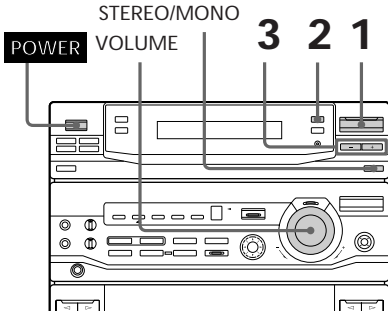

**1** Press TUNER/BAND repeatedly until the band you want appears in the display.

Each time you press this button, the band changes as follows:

FM ↔ AM

**2** Press TUNING MODE repeatedly until "PRESET" appears in the display.

MANUAL → AUTO → PRESET



**3** Press TUNING +/- (or ⏪/⏩) on the remote) to tune in the desired preset station.

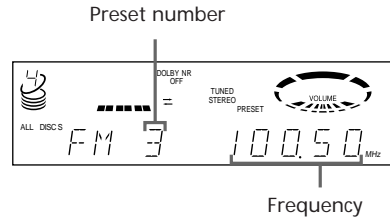

To	Do this
Turn off the radio	Press POWER.
Adjust the volume	Turn VOLUME (or press VOL +/- on the remote).

### To listen to non-preset radio stations

Press TUNING MODE repeatedly in step 2 until "MANUAL" appears, then press TUNING +/- to tune in the desired station.

#### Tips

- Pressing TUNER/BAND while the system is off automatically turns on the system and tunes to the last received station (One Touch Play).
- You can switch from another source to the radio just by pressing TUNER/BAND (Automatic Source Selection).
- If an FM program is noisy, press STEREO/MONO so "MONO" appears in the display. There will be no stereo effect, but the reception will improve. Press this button again to restore the stereo effect.
- To improve broadcast reception, move the supplied antennas.

# Recording from the radio

You can record a radio program on a tape by tuning in a preset station. You can use TYPE I (normal) or TYPE II (CrO<sub>2</sub>) tapes.

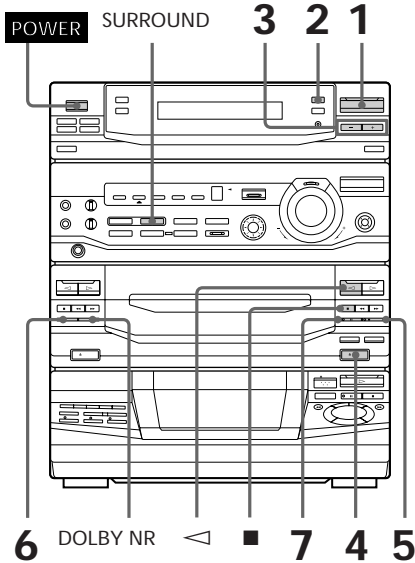

- 1 Press TUNER/BAND repeatedly until the band you want appears in the display.
- 2 Press TUNING MODE repeatedly until "PRESET" appears in the display.

- 3 Press TUNING +/- to tune in a preset station.

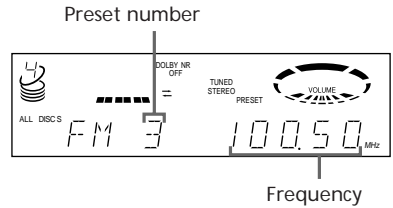

- 4 Press EJECT and insert a blank tape into deck B.

With the side you want to record on facing forward

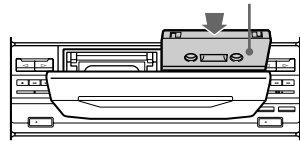

- 5 Press REC.  
Deck B stands by for recording, and the indicator on the button (for the front side) lights up green.
- 6 Press DIRECTION repeatedly to select to record on one side or (or RELAY) to record on both sides.

- 7 Press on deck B.  
Recording starts.

## To stop recording

Press on deck B.





## Playing a tape (continued)

- 1 Press **EJECT** and insert a recorded tape in deck A or B.

With the side you want to play facing forward

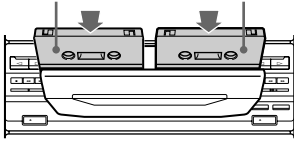

- 2 Press **DIRECTION** repeatedly to select  $\rightleftarrows$  to play one side,  $\rightleftarrows^*$  to play both sides, or **RELAY** (Relay Play)\*\* to play both decks in succession.

- 3 Press  $\triangleright$ .

Press  $\triangleleft$  to play the reverse side. The tape starts playing.

\* The deck stops automatically after playing both sides five times.

\*\* Relay Play always plays according to the following sequence:

Deck A (front side), Deck A (reverse side), Deck B (front side), Deck B (reverse side).

To	Do this
Stop play	Press <b>■</b> (or <b>□</b> on the remote).
Pause (Deck B only)	Press <b>  </b> (or <b>  </b> on the remote). Press again to resume play.
Fast-forward	Press <b>▶▶</b> while playing the front side or <b>◀◀</b> while playing the reverse side (or press <b>&lt;&lt;/&gt;&gt;</b> on the remote).
Rewind	Press <b>◀◀</b> while playing the front side or <b>▶▶</b> while playing the reverse side (or press <b>&lt;&lt;/&gt;&gt;</b> on the remote).
Remove the cassette	Press <b>EJECT</b> .
Adjust the volume	Turn <b>VOLUME</b> (or press <b>VOL +/-</b> on the remote).

## Tips

- Pressing  $\triangleright$  or  $\triangleleft$  while the system is off automatically turns on the system and starts tape playback if there is a tape in the deck (One Touch Play).
- You can switch from another source to the tape deck just by pressing  $\triangleright$  or  $\triangleleft$  (Automatic Source Selection).
- When you want to reduce the hiss noise in low-level high-frequency signals, press **DOLBY NR** so "DOLBY NR B" appears in the display.

# Recording from a tape

## — High-speed Dubbing

You can use TYPE I (normal) or TYPE II (CrO<sub>2</sub>) tapes.

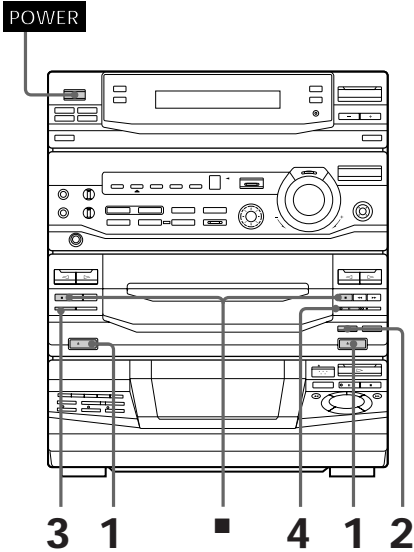

- 1 Press **▲ EJECT** and insert a recorded tape in deck A and a blank tape in deck B.

With the side you want to play/record on facing forward

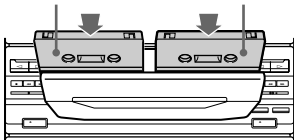

- 2 Press **H SPEED DUB**.  
Deck B stands by for recording.

- 3 Press **DIRECTION** repeatedly to select **←** to record on one side or **↔** (or **RELAY**) to record on both sides.

- 4 Press **II**.  
Dubbing starts.  
When dubbing ends, decks A and B automatically stop.

### To stop dubbing

Press **■** on deck A or B.

### Tips

- When you dub on both sides, start recording from the front side. If you start from the reverse side, recording stops at the end of the reverse side.
- If you set **DIRECTION** to **↔** when the tapes you use have different lengths, the tape in each deck reverses independently. If you select **RELAY**, the tapes in both decks reverse together.
- You don't have to set **DOLBY NR**, since the tape in deck B is automatically recorded in the same state as the tape in deck A.

### Note

You cannot record the surround effect.

# Singing along: Karaoke

You can sing along with any stereo CD or tape by turning down the singer's voice. You need to connect an optional microphone.

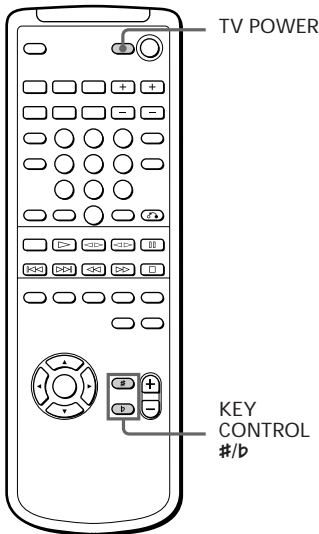
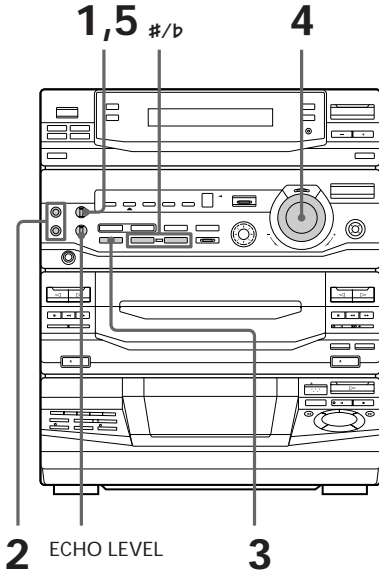

- 1 Turn MIC LEVEL to MIN to turn down the microphone level.
- 2 Connect an optional microphone to the MIC 1 jack.  
When you use two microphones at the same time, connect the other one to the MIC 2 jack.

- 3 Press KARAOKE PON/MPX repeatedly to obtain the desired karaoke effect.  
Each time you press this button, the display changes as follows:  
KARAOKE PON → MPX R → MPX L  
↑ EFFECT OFF (ON) ↓  
“🎤” appears in the display when the karaoke mode is activated.

To	Select
Reduce the singer's voice on a CD or tape	KARAOKE PON
Reduce the left channel on a multiplex CD or tape.	MPX R
Reduce the right channel on a multiplex CD or tape.	MPX L

- 4 Start playing the music and adjust the volume.
- 5 Turn MIC LEVEL to adjust the microphone volume.

## When you use VIDEO CDs

Turn on your TV and switch it to the appropriate video input.

Refer to the operating instructions supplied with your TV for details.

## When you are done

Turn MIC LEVEL to MIN and disconnect the microphone from MIC, then press KARAOKE PON/MPX repeatedly until “🎤” disappears from the display.

## Adjusting the microphone echo

---

- ➔ Turn ECHO LEVEL to adjust the echo effect.
- 

### To cancel the echoing

Turn ECHO LEVEL to MIN.

## Adjusting the key

---

- ➔ Press **b** or **#** (or KEY CONTROL **#**/**b** on the remote).

You can adjust the key higher or lower in 13 half-tone steps (-3.0 to 3.0).

---

### Notes

- If you press EFFECT or select a sound effect, the karaoke mode is canceled.
- The instrumental sound may be reduced as well as the singer's voice when the source sound was recorded monaurally.
- The singer's voice may not be reduced when:
  - only a few instruments are playing.
  - a duet is being sung.
  - the source has strong echoes or chorus.
  - the singer's voice deviates from the center.
  - the voice on the source is singing high soprano or tenor notes.

## Playing a VIDEO CD with PBC functions (Ver 2.0)

### — PBC Play

The PBC (PlayBack Control) function displays menus on your TV screen to let you enjoy interactive software.

Be sure to read the instructions supplied with each disc for details regarding its use since different discs have different menu formats and structures.

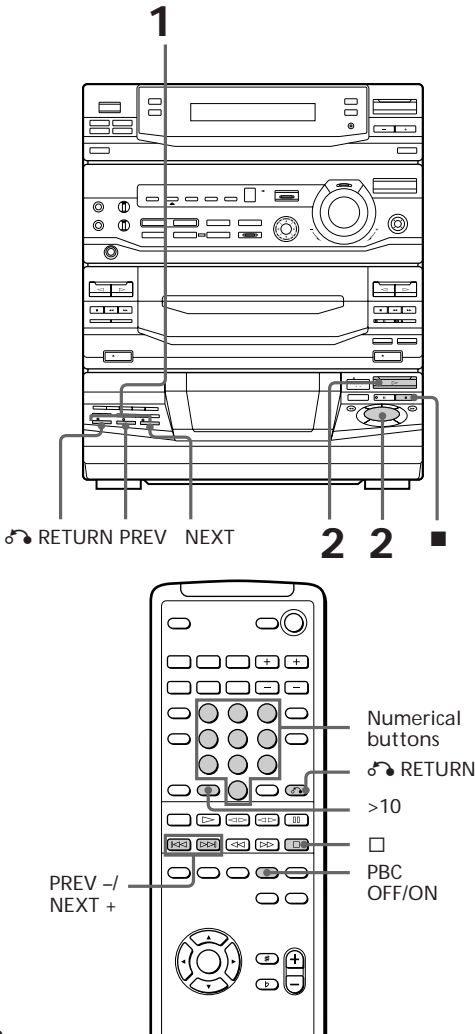

### 1 Start playing a VIDEO CD with PBC functions (Ver 2.0).

All of the following indicators light up and a PBC menu appears on your TV.



- VCD indicator:

Lights during playback of a VIDEO CD.

- PBC indicator:

Lights during playback of a VIDEO CD with PBC functions (Ver 2.0) (even if the PBC function is not being used).

- AUTO PBC indicator:

Lights during menu playback of a VIDEO CD with the PBC functions (Ver 2.0).

### 2 Turn the jog dial to select a number in a menu, then press SELECT ▽.

### 3 Continue according to the instructions on the menus to enjoy interactive playback.

To	Do this
Stop play	Press ■ (or □ on the remote).
See the rest of a menu	Press NEXT (or NEXT + on the remote).
Go back to the top of a menu	Press PREV (or PREV - on the remote).
Go back to a previous menu	Press ↶ RETURN.

## To cancel PBC Play

Press PBC OFF/ON on the remote repeatedly until the AUTO PBC indicator goes off.

Still images, such as the menu screens, will not be shown.

## To select a number of the menu with the remote

Press the numerical buttons in the order you want in step 2. To enter track numbers 10 or over, first press >10, then press the numerical buttons. To enter 0, use the 10/0 button.

### Tips

- When  appears on the TV screen, you have pressed an invalid button. Press a button indicated by the instructions on the menu screen.
- When you press NEXT (or NEXT + on the remote) during menu playback or while playing moving pictures, the next scene on the disc appears. Also refer to the instructions supplied with the disc.

### Note

The CD player will stop playing in the following cases:

- When you press PBC OFF/ON on the remote during playback.
- When you press PLAY MODE during playback.

## Using the CD display

You can check the remaining time of the current track or the whole CD.

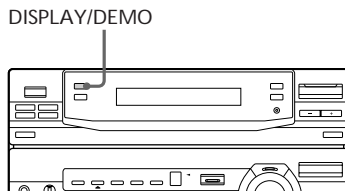

### ➔ Press DISPLAY/DEMO during playback.

Each time you press this button in Normal Play, the display changes as follows:

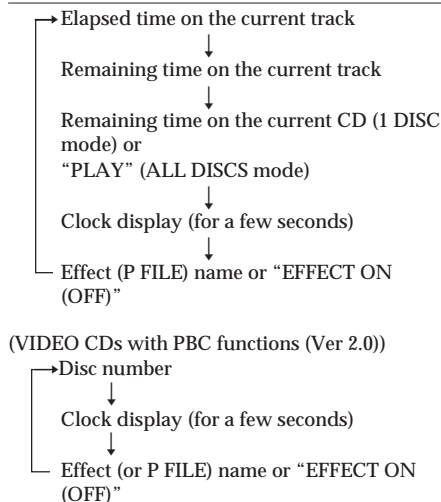

## To check the total playing time and the number of tracks on a CD

Press DISPLAY/DEMO in stop mode.

If you press DISPLAY/DEMO again, the clock display appears for a few seconds then the display returns to the previous indication.

### Tip

While playing an audio CD or a VIDEO CD without PBC function (Ver 1.1), the current track number and elapsed time of the current track appear.

# Using the on-screen display

You can check the current operating status and disc information of VIDEO CDs or audio CDs during playback or in stop mode by superimposing a display on top of the images on your TV screen.

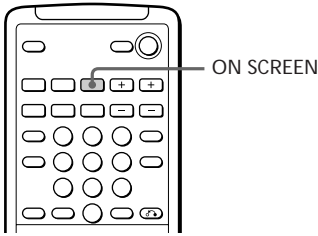

➔ Press ON SCREEN.

Each time you press this button, the on-screen display changes as follows:

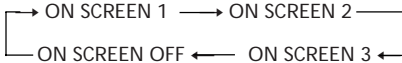

## ON SCREEN 1 display

Momentary display of the operating status when you perform an operation (such as starting playback).

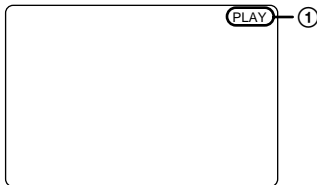

- ① Operating status
  - “PLAY” when you start playback
  - “STOP” when you stop playback
  - “PAUSE” when you pause playback

- During stop mode in Program Play

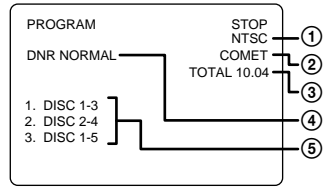

- ① Color system
- ② “ACTIVE,” “COMET,” or no display
- ③ Total playing time of the program
- ④ Advanced DNR status
- ⑤ Programmed disc and track numbers

## ON SCREEN 2 display

- During playback

Either the elapsed time or remaining time of the current track is usually displayed.

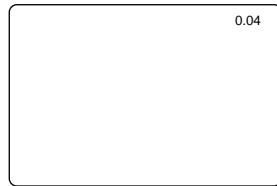

- During stop mode (except for Program Play)

The status of the ACTIVE/COMET and advanced DNR functions are also displayed.

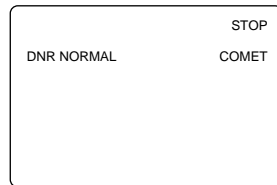

- During stop mode in Program Play  
Display is the same as ON SCREEN 1.



## ON SCREEN 3 display

During playback, this screen displays the operating status.

During stop mode, it displays information about the CD(s) on the disc tray.

### • In Normal or Shuffle Play

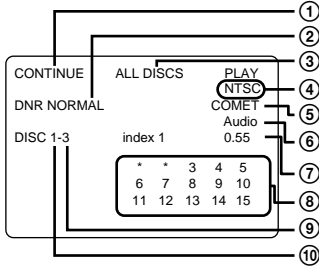

- ① Play mode
  - ② Advanced DNR status
  - ③ "ALL DISCS" or "1 DISC"
  - ④ Color system
  - ⑤ "ACTIVE," "COMET," or no display
  - ⑥ Type of disc
  - ⑦ Elapsed time of the current track
  - ⑧ Music calendar\*
  - ⑨ Current track number
  - ⑩ Current disc number
- \* The track numbers in the numerical calendar disappear after they are played.

### • In Program Play

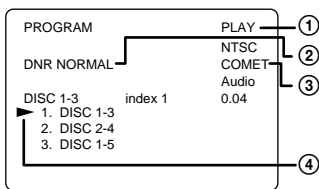

- ① "PLAY" when you start playback  
"PAUSE" when you pause playback
- ② Advanced DNR status
- ③ "ACTIVE," "COMET," or no display
- ④ Indicates the current track

### • During menu playback of a VIDEO CD with PBC functions

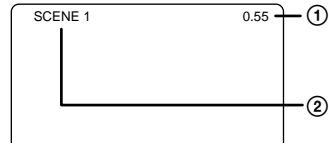

- ① Elapsed time of the scene
- ② Scene number

### • During stop mode (except for Program Play)

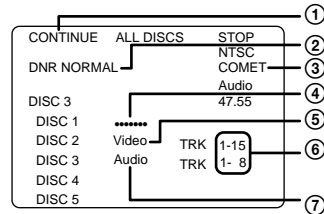

- ① Play mode
- ② Advanced DNR status
- ③ "ACTIVE," "COMET," or no display
- ④ For discs that have not been played
- ⑤ For a VIDEO CD
- ⑥ Track numbers on the disc
- ⑦ For an audio CD

### • During stop mode in Program Play Display is the same as ON SCREEN 1.

## ON SCREEN OFF

No display (except for special menus).

### Notes

- Normally, leave the display mode set to either ON SCREEN 1, 2, or 3. When you select ON SCREEN OFF, you cannot check the operating status while operating the CD player. In this case, check the information on the front panel display.
- When you record video signals played back from this system onto a video tape (etc.), be sure to select ON SCREEN OFF. Otherwise, the display information will also be recorded on the video tape.

# Locating a specific part of a disc

## -- Special Menu

This player has 5 different search features. Select the search feature you want from the SPECIAL MENU.

The TV screen must be ON to use these functions.

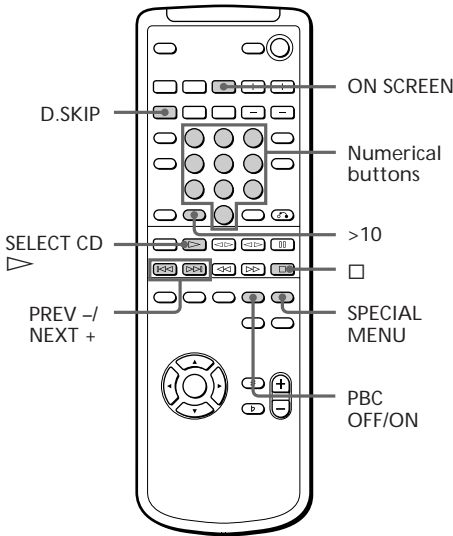

# Locating by Scene Number

## -- Scene Search

On VIDEO CDs with PBC functions (Ver 2.0), the menu screens, moving pictures, and still pictures are divided into "scenes" and each scene has an assigned scene number. This function lets you start playback from a specific scene.

- 1 Start playing a VIDEO CD with PBC functions (Ver 2.0).
- 2 Press SPECIAL MENU.
- 3 Press 1 to select "1) SCENE SEARCH."  
"SCENE -" and the total number of scenes appear on the TV screen.

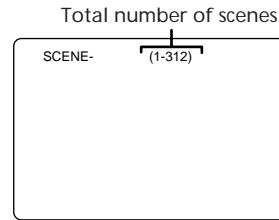

- 4 Press the numerical buttons (1 - 10/0) on the remote to select the scene you want.

To enter scene number 103:  
Press 1 → 10/0 → 3. The selected scene number appears on the TV screen.

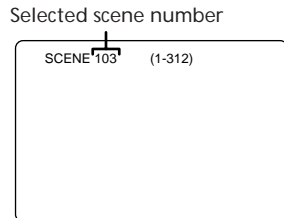

- 5 Press SELECT CD ▷.
- Playback starts from the selected scene.

## To stop playback

Press □.

## To check the scene number during playback

Press ON SCREEN repeatedly to select the ON SCREEN 3 display mode. The scene number appears on the TV screen. (See “Using the on-screen display” for details.)

### Notes

- On some CDs, you may not be able to start playing from the scene you select because starting playback from certain scenes is prohibited.  
In this case, play either starts from scene 1 (during stop mode) or continues from the current scene (during playback).
- Some CDs may not display the scene you select on the TV screen.

## Locating by index number

### — Index Search

An “index” is a number that divides a track or a disc into smaller sections so you can easily locate the point you want. The index of a VIDEO CD is called a “Video Index.”

This function lets you start playback from a specific point of a track or disc with index numbers.

This function cannot be used during menu playback of VIDEO CDs with PBC functions (Ver 2.0).

- 
- 1 Start playing an audio CD or VIDEO CD.
- 
- 2 Press SPECIAL MENU.
- 
- 3 Press 2 to select “2) V-INDEX SEARCH” (or “2) INDEX SEARCH” for audio CDs).

- 
- 4 Press the numerical buttons (1 – 10/0) on the remote to select the index you want.

The selected index number appears on the TV screen.

Selected index number

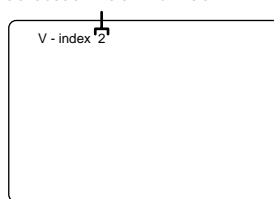

- 
- 5 Press SELECT CD ▷.
- Playback starts from the selected index.
- 

## To stop playback

Press □.

## To use Index Search with VIDEO CDs with PBC functions (Ver 2.0)

Stop playback and press PBC OFF/ON on the remote repeatedly until the AUTO PBC indicator goes off before step 1.

### Notes

- Index Search can only be used with discs that have index numbers. Likewise, Index Search cannot be used to skip between adjacent tracks.
- If there are no more indexes while playing a VIDEO CD, a hand icon appears on the TV screen and the player continues playing.

## Locating a specific part of a disc (continued)

### Locating by elapsed time

#### -- Time Search

This function lets you use elapsed time as a guide to find a certain parts of a VIDEO CD without PBC functions (Ver 1.1) and audio CDs. "Elapsed time" means the time from the beginning of the disc. It is not the playing time of the current track as shown in the display.

It is especially useful when playing discs that have only a few track divisions.

This function cannot be used during menu playback of VIDEO CDs with PBC functions (Ver 2.0).

---

**1** Press SPECIAL MENU.

---

**2** Press 3 to select "3) TIME SEARCH."

---

**3** Press the numerical buttons (1 - 10/0) on the remote to enter the time (in minutes) for the section you want. To enter 10 minutes: Press 1 → 10/0. The selected elapsed time appears on the TV screen.

---

**4** Press SELECT CD  $\triangleright$ . Playback starts from the selected time.

---

#### To stop playback

Press  $\square$ .

#### To use Time Search with VIDEO CDs with PBC functions (Ver 2.0)

Stop playback and press PBC OFF/ON on the remote repeatedly until the AUTO PBC indicator goes off before step 1.

#### Note

Playback may not start from the exact time you selected depending on the CD.

## Locating the track you want

#### -- Disc Digest

You can select the track you want by viewing the first frame of each track. Up to 9 different tracks can be displayed on the TV screen at one time.

This function cannot be used during menu playback of VIDEO CDs with PBC functions (Ver 2.0).

---

**1** Press SPECIAL MENU.

---

**2** Press 4 to select "4) DISC DIGEST." The first frame of the picture in tracks 1 through 9 on the current disc are displayed. The sound of the first three seconds of each track on an audio CD plays, but there is no sound when using a VIDEO CD.

Current disc number

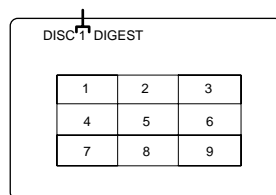

---

**3** Press the numerical buttons (1 - 10/0) to select the track you want.

---

#### To stop playback

Press  $\square$ .

## To display the next 9 tracks

Press NEXT +. The first frame of tracks 10 through 18 are displayed.

When there are more tracks in the disc, "▷▶|I" appears in the upper right corner of the TV screen.

To display previous tracks, press PREV -.

## To switch to the digest of another disc during Disc Digest

Press D.SKIP during Disc Digest.

## To use Disc Digest with VIDEO CDs with PBC functions (Ver 2.0)

Stop playback and press PBC OFF/ON so that the AUTO PBC indicator goes off before step 1.

### Tips

- In step 2, you can select tracks even if they have not been displayed yet. Use the numerical buttons to select the track you want.
- In step 2, you can play the track you want immediately after the first frame of the picture is displayed by pressing SELECT CD ▷.

### Notes

- Video images will not be shown for audio CDs.
- The play mode automatically switches to normal mode if you start Disc Digest during Shuffle or Program Play.

## Locating a section within a track

### -- Track Digest

You can have the CD player divide a VIDEO CD track into 9 different sections and display the first scene of each section on the TV screen. This might be useful when playing discs with few track divisions, such as movies.

This function cannot be used during menu playback of VIDEO CDs with PBC functions (Ver 2.0).

---

**1** Start playing the VIDEO CD track you want.

---

**2** Press SPECIAL MENU.

---

**3** Press 5 to select "5) TRACK DIGEST."

The current track is divided into 9 sections, and the first frame of each section is displayed.

The sound of the first three seconds of each track on an audio CD plays, but there is no sound when using a VIDEO CD.

Current track number

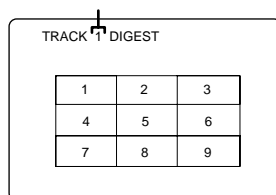

---

**4** Press the numerical buttons to select the section you want.

Playback starts from a point near the selected frame.

---

## To stop playback

Press □.

## Locating a specific part of a disc (continued)

### To switch to the digest of another track during Track Digest

Press PREV – or NEXT + during Track Digest; however, this does not work during Shuffle Play or Program Play.

### To use Track Digest with VIDEO CDs with PBC functions (Ver 2.0)

Stop playback and press PBC OFF/ON so the AUTO PBC indicator goes off before step 1.

#### Tips

- In step 3, you can select sections even if they have not been displayed yet.  
Use the numerical buttons to select the track you want.
- In step 3, you can play the section you want immediately after the first frame of the picture is displayed by pressing SELECT CD ▷.

#### Note

Tracks less than 40 seconds long may be divided into fewer than 9 sections.

---

## Playing a VIDEO CD from where it was last stopped

### -- Resume Play

When playing a VIDEO CD, the CD player will remember where playback was stopped. Therefore, you can play a VIDEO CD starting from the point where it was last stopped.

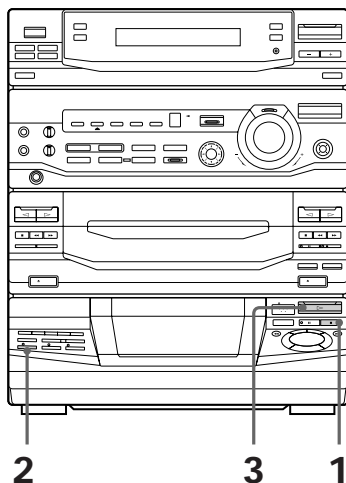

---

**1** Press ■ (or □ on the remote) to stop VIDEO CD playback.  
The CD player remembers this position.

---

**2** Press ↻ RETURN during stop mode.  
“RESUME” flashes in the display and appears on the TV screen for about 16 seconds.

---

**3** Press ▷ while “RESUME” is flashing.  
Playback resumes from the point where it was stopped in step 1.  
If “RESUME” stops flashing before you press ▷, press ↻ RETURN again.

---

## To play a VIDEO CD from the beginning

- Press  $\triangleright$  while “RESUME” is not flashing.
- Press  $\curvearrowright$  RETURN again while “RESUME” is flashing.

### Notes

- Resume Play does not work with audio CDs.
- If “RESUME” does not flash, Resume Play cannot be used.
- Resume Play does not work during Shuffle or Program Play.
- Depending on where you stop playback, Resume Play may not resume from the exact same point or may not work.
- The following operations will clear the resume memory:
  - Removing the disc
  - Pressing DISC SKIP (or D.SKIP on the remote)
  - Unplugging the power cord
  - Switching the play mode
  - Pressing  $\blacksquare$  (or  $\square$  on the remote) during stop mode

---

## Reducing distortion of the picture with advanced DNR

You can select the level of the advanced DNR function to reduce either flickering pictures or block noise.

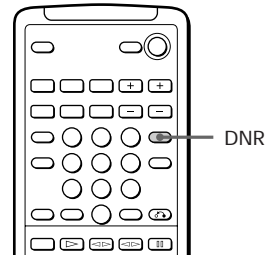

---

➔ Press DNR on the remote.

Each time you press this button, the display changes as follows:

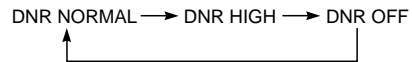

To reduce the block noise more effectively, select “DNR HIGH.”

---

### To cancel advanced DNR

Press DNR repeatedly until “DNR OFF” appears.

### Notes

- When you use the DNR function, parts of the picture may be out of focus.
- When you connect the AC power cord of the unit to a wall outlet, “DNR NORMAL” is selected automatically.
- The advanced DNR function cannot reduce the outline noise in the picture.

## Setting the sharpness

### -- Active Picture

You can make the picture more active by emphasizing the outline of the picture to get a sharper picture.

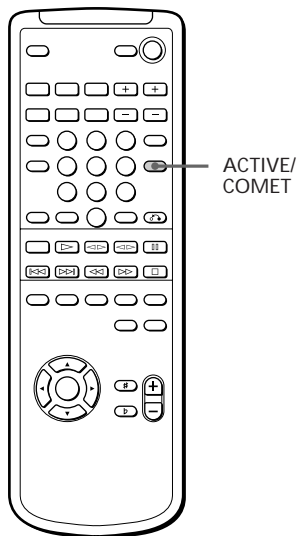

➔ Press ACTIVE/COMET to select "ACTIVE PICTURE."

Each time you press this button, the display changes as follows:

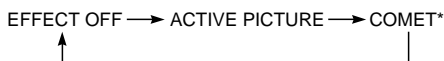

\* See "Adding trails to moving pictures."

### To cancel Active Picture

Press ACTIVE/COMET repeatedly until "EFFECT OFF" appears.

#### Note

When you turn the system off, "EFFECT OFF" is selected automatically.

## Adding trails to moving pictures

### -- COMET

You can set the unit to add trails to moving pictures (COMET). The COMET function gives atmosphere to the picture.

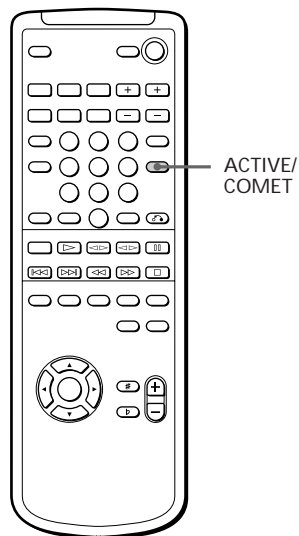

➔ Press ACTIVE/COMET to select "COMET."

Each time you press this button, the display changes as follows:

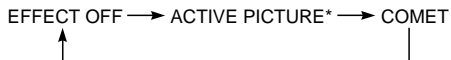

\* See "Setting the sharpness."

### To cancel COMET

Press ACTIVE/COMET repeatedly until "EFFECT OFF" appears.

#### Note

When you turn the system off, "EFFECT OFF" is selected automatically.



## Playing CD tracks repeatedly

### — Repeat Play

This function lets you repeat a single CD or all CDs in Normal Play, Shuffle Play, and Program Play.

This function cannot be used during menu playback of VIDEO CDs with PBC functions (Ver 2.0).

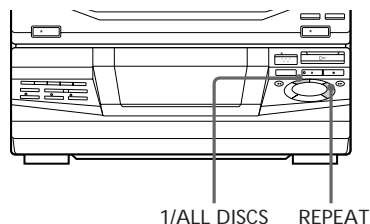

➔ Press REPEAT repeatedly during playback until “REPEAT” appears in the display.

Repeat Play starts. The following table describes the various repeat modes.

To repeat	Press
All the tracks on the current CD	1/ALL DISCS repeatedly until “1 DISC” appears in the display.
All the tracks on all CDs	1/ALL DISCS repeatedly until “ALL DISCS” appears in the display.
Only one track*	REPEAT repeatedly while playing the track you want to repeat until “REPEAT 1” appears in the display.

\* You can't repeat a single track during Shuffle Play and Program Play.

### To cancel Repeat Play

Press REPEAT repeatedly until “REPEAT” or “REPEAT 1” disappears from the display.

## Playing CD tracks in random order

### — Shuffle Play

You can play all the tracks on one CD or all the CDs in random order.

This function cannot be used during playback of VIDEO CDs with PBC functions (Ver 2.0).

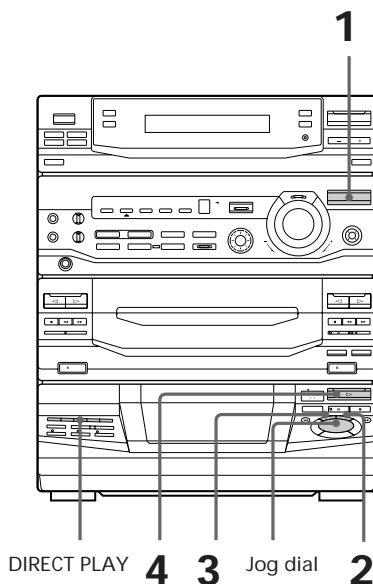

- 1 Press FUNCTION repeatedly until “CD” appears in the display.
- 2 Press PLAY MODE repeatedly until “SHUFFLE” appears in the display.
- 3 Press 1/ALL DISCS to choose “1 DISC” or “ALL DISCS.”  
“ALL DISCS” shuffles the tracks on all the CDs in the player. “1 DISC” shuffles the tracks on the CD in the playing position.
- 4 Press  $\triangleright$ .  
“ $\text{E}_j$ ” appears and all the tracks play in random order.

continued

## Playing CD tracks in random order (continued)

### To cancel Shuffle Play

Press PLAY MODE repeatedly until "SHUFFLE" or "PROGRAM" disappears from the display. The tracks continue playing in their original order.

If you are playing VIDEO CDs with PBC functions (Ver 2.0), the CD player stops.

### To select a desired CD

Press one of the DIRECT PLAY buttons during 1 Disc Shuffle Play.

### Tips

- You can start Shuffle Play during Normal Play by pressing PLAY MODE repeatedly until "SHUFFLE" appears in the display.
- To skip a track, turn the jog dial clockwise (or press  $\triangleright$  on the remote).

## Programming CD tracks

### -- Program Play

You can create a program of up to 32 tracks from all the CDs in the order you want them to be played.

This function cannot be used during menu playback of VIDEO CDs with PBC functions (Ver 2.0).

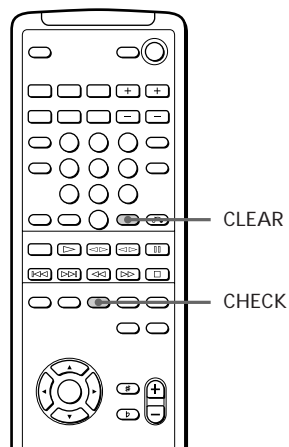
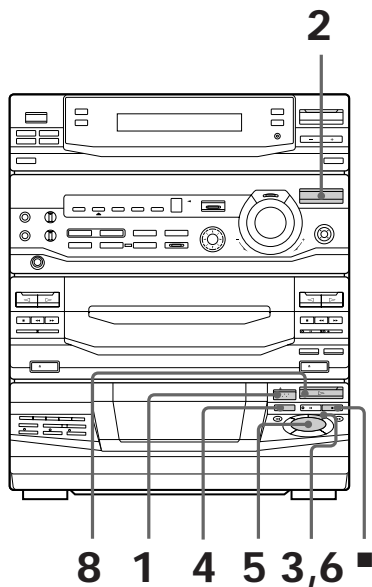

**1** Place CDs and close the front cover.

**2** Press FUNCTION repeatedly until “CD” appears in the display.

**3** Press PLAY MODE repeatedly until “PROGRAM” appears in the display.

**4** Press DISC SKIP to select a CD.

**5** Turn the jog dial until the desired track appears in the display.

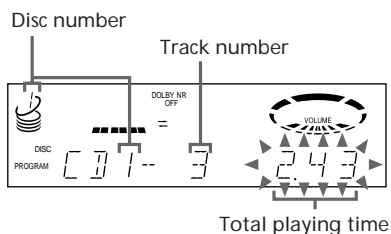

**6** Press PLAY MODE once.

The track is programmed. “STEP” and the programmed playing order appear, followed by the total playing time.

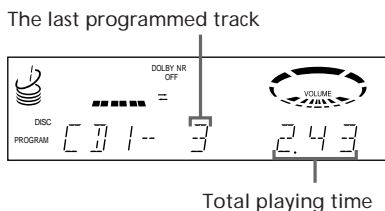

**7** Repeat steps 4 through 6 to program additional tracks.

Skip step 4 to select tracks from the same disc.

**8** Press  $\triangleright$ .

All the tracks play in the order you selected.

## To cancel Program Play

Press PLAY MODE repeatedly until “PROGRAM” or “SHUFFLE” disappears from the display.

To	Press
Check the program	CHECK on the remote repeatedly. After the last track, “CHECK END” appears.
Clear the last selected track	CLEAR on the remote in stop mode.
Clear a specific track	CHECK on the remote repeatedly until the number of the track to be cleared lights up, then press CLEAR.
Add a track to the program	1 Press DISC SKIP to select a CD. 2 Turn the jog dial to select a track. 3 Press PLAY MODE.
Clear the entire program	■ once in stop mode or twice while playing.

## Tips

- The program you created remains in the CD player's memory even after it has been played. Press  $\triangleright$  to play the same program again.
- If “--” appears instead of the total playing time while programming, this means:
  - you have programmed a track numbered over 20, or
  - the total playing time has exceeded 100 minutes.

---

# Playing CDs without interruption

## — CD Non-Stop Play

You can play CDs without pausing between tracks.

You cannot use this function with VIDEO CDs.

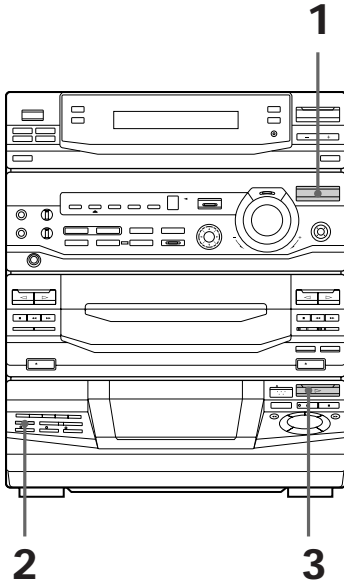

---

**1** Press FUNCTION repeatedly until “CD” appears in the display.

---

**2** Press CD NON-STOP so the indicator on this button lights up.

---

**3** Press ▷.

---

### To cancel CD Non-Stop Play

Press CD NON-STOP so the indicator on this button goes off.

## Recording on a tape manually

You can record from CDs, tapes, or the radio as you like. For example, you can record just the songs you want or begin recording from the middle of the tape.

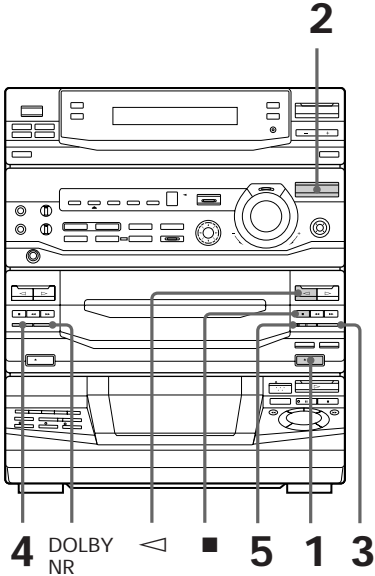

**5** Press **II** on deck B.  
Recording starts.

**6** Start playing the source to be recorded.

To	Press
Stop recording	■ on deck B
Pause recording	II on deck B

### Tips

- If you want to record on the reverse side, press ◁ on deck B so the indicator on the ◁ button (for the reverse side) lights up green.
- When you want to reduce the hiss noise in low-level high-frequency signals, press DOLBY NR before step 5 so "DOLBY NR B" appears in the display.

**1** Insert a blank tape into deck B.

**2** Press FUNCTION repeatedly until the source you want to record (e.g., CD) appears in the display.

**3** Press ● REC.  
Deck B stands by for recording, and the indicator on the ▷ button (for the front side) lights up green.

**4** Press DIRECTION repeatedly to select ⇄ to record on one side or ↔ (or RELAY) to record on both sides.

# Recording CDs by specifying the track order

## — Program Edit

You can record tracks from all the CDs in the order you want. When programming, make sure the playing times for each side do not exceed the length of one side of the tape.

This function cannot be used during menu playback of VIDEO CDs with PBC functions (Ver 2.0).

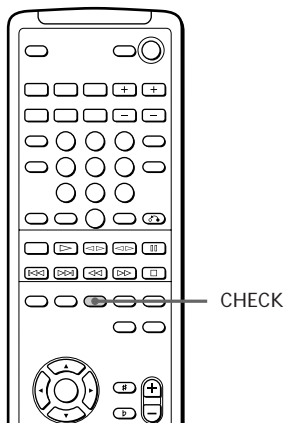
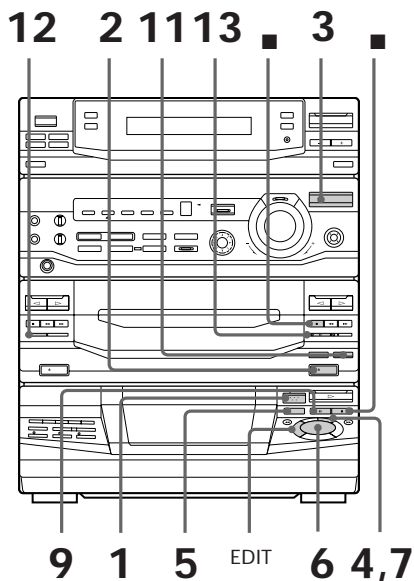

- 1 Place CDs and close the front cover.
- 2 Insert a blank tape into deck B.
- 3 Press FUNCTION repeatedly until "CD" appears in the display.
- 4 Press PLAY MODE repeatedly until "PROGRAM" appears in the display.
- 5 Press DISC SKIP to select a CD.
- 6 Turn the jog dial until the desired track appears in the display.

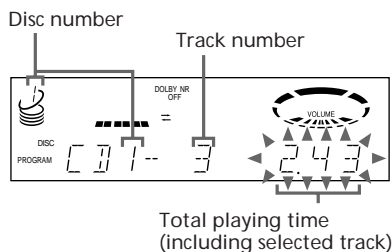

- 7 Press PLAY MODE once. The track is programmed. "STEP" and the programmed playing order appear, followed by the total playing time.

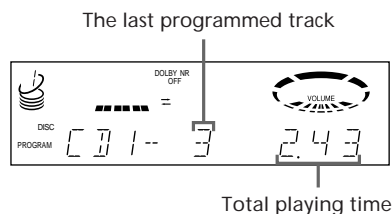

- 8 Repeat steps 5 through 7 to program additional tracks to be recorded on side A. Skip step 5 to select tracks from the same disc.

---

**9** Press **II** to insert a pause at the end of side A.

“P” appears in the display and the total playing time resets to “0.00” in the display.

---

**10** Repeat steps 5 through 7 to program the tracks to be recorded on side B.

Skip step 5 to select tracks from the same disc.

---

**11** Press CD SYNC.

Deck B stands by for recording, the CD player stands by for playback, and the indicator on the  $\triangleright$  button (for the front side) lights up green.

---

**12** Press DIRECTION repeatedly to select  $\leftarrow$  to record on one side or  $\leftrightarrow$  (or RELAY) to record on both sides.

---

**13** Press **II** on deck B.  
Recording starts.

---

### To stop recording

Press **II** on deck B or on the CD player.

### To check the order

Press CHECK on the remote repeatedly. After the last track, “CHECK END” appears.

### To cancel Program Edit

Press PLAY MODE repeatedly until “PROGRAM” or “SHUFFLE” disappears from the display.

## Selecting the tape length automatically

### — *Tape Select Edit*

You can check the most suitable tape length for recording a CD. Note that you cannot use Tape Select Edit for discs containing more than 20 tracks.

This function cannot be used during menu playback of VIDEO CDs with PBC functions (Ver 2.0).

---

➔ After inserting a CD, press EDIT once so “EDIT” flashes.

The required tape length for the CD in the playing position appears, followed by the total playing time for sides A and B.

---

### Note

You cannot use this function when Program Play mode has been set. After clearing the entire program (see “To clear the entire program” on page 35), follow the above procedure.

## Looping part of a CD

### — CD Loop

With the loop function, you can repeat part of a CD during playback. This lets you create original recordings.

You cannot use this function with VIDEO CDs.

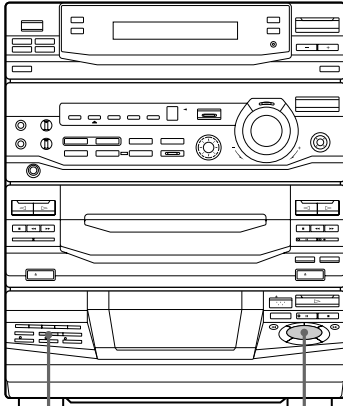

CD LOOP

Jog dial

➔ Press and hold CD LOOP during playback at the point you want to start the Loop function, and release to resume normal playback.

### To adjust the loop length

Turn the jog dial while holding CD LOOP (or press MUSIC MENU </> while holding LOOP on the remote) to select different loop lengths.

## Flashing part of a CD

### — CD Flash

With the flash function, you can “flash” the CD sound during playback. This lets you create original recordings.

You cannot use this function with VIDEO CDs.

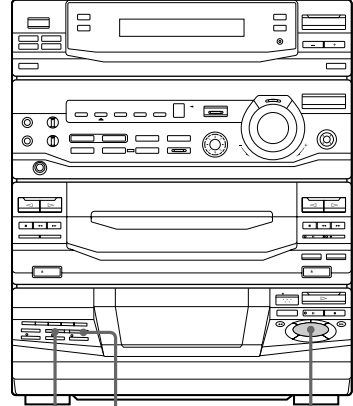

CD LOOP CD FLASH

Jog dial

➔ Press and hold CD FLASH during playback at the point you want to start the Flash function, and release to resume normal playback.

### To adjust the flash length

Turn the jog dial while holding CD FLASH (or press MUSIC MENU </> while holding FLASH on the remote) to select different flash lengths.

### To use LOOP and FLASH together

Press and hold both CD LOOP and CD FLASH at the same time.

### Note

The loop and flash length cannot be adjusted in stop mode. Adjust the loop and flash lengths during operation.



---

# Waving the equalizer

## — Wave

With the Wave function, you can fluctuate the graphic equalizer automatically while listening to a source. This effect can be used with any source, but it cannot be recorded.

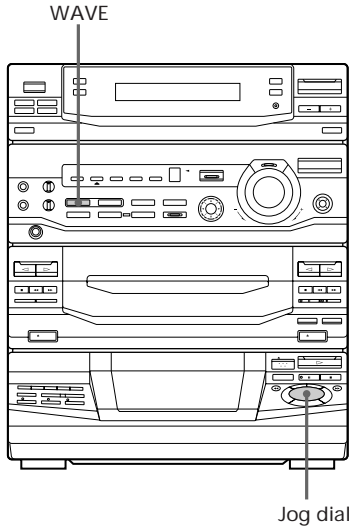

---

➔ Press and hold WAVE while listening to a source at the point you want to start the Wave function, and release to resume normal playback.

---

### To adjust the wave length

Turn the jog dial while holding WAVE to select different wave lengths.

## Adjusting the sound

You can reinforce the bass, create a more powerful sound, and listen with headphones.

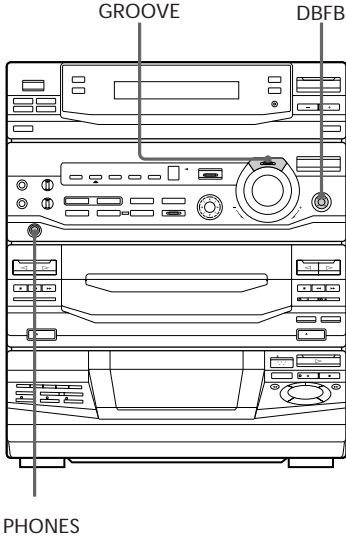

### To reinforce the bass (DBFB)

Press DBFB\*.

Each time you press this button, the DBFB level display changes as follows:

DBFB ■■■ → DBFB ■■■■■ → display off

“DBFB ■■■■■” reinforces the bass more than “DBFB ■■■.”

\* DBFB = Dynamic Bass Feedback

### For a powerful sound (GROOVE)

Press GROOVE.

The volume switches to power mode, the equalizer curve changes, the bass level (DBFB) changes to “HIGH,” and the indicator on the GROOVE button lights up. Press GROOVE again to return to the previous volume.

### Notes

- The music sound will be distorted when you use the DBFB system with the graphic equalizer if the bass is too strong. Adjust the bass slowly while listening to the music so you can monitor the effect of the adjustment.
- Canceling GROOVE cancels the equalizer curve and bass level. Adjust the equalization to obtain the effect you desire.

### To listen through the headphones

Connect the headphones to the PHONES jack.

No sound will come from the speakers.

# Selecting the audio emphasis

The audio emphasis menu lets you select the sound characteristics according to the music you are listening to.

The personal file function (see “Making a personal audio emphasis file (Personal File)”) lets you store your own effects.

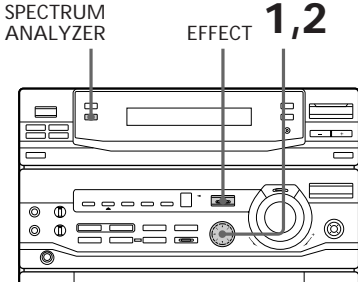

**1** Press GEQ ▲/▼ (or MUSIC MENU Δ / ▽ on the remote) repeatedly to select MENU 1 or MENU 2.

See the chart “Music menu options” below. The last audio emphasis chosen from that menu appears in the display.

**2** Press GEQ ◀/▶ (or MUSIC MENU ◀ / ▶ on the remote) repeatedly to select the audio emphasis you desire.

The audio emphasis name appears in the display.

## Music menu options

“SUR (|||||)” appears if you select an audio emphasis with a surround effect.

Press	To select	
GEQ ▲/▼	MENU 1	MENU 2
GEQ ◀/▶	ROCK	MOVIE
	POP	GAME
	JAZZ	NIGHT
	DANCE	PARTY
	SALSA	RELAX

## To change the equalizer display

Each time you press SPECTRUM ANALYZER, the equalizer display changes to show one of the four displays below.

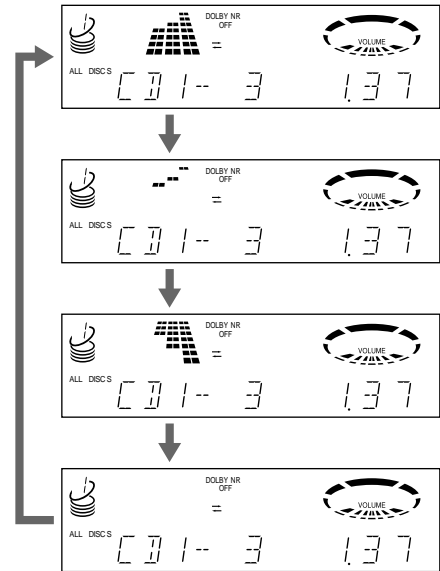

## To cancel the audio emphasis

Press EFFECT (or MUSIC MENU ON/OFF on the remote) repeatedly so the indicator on the EFFECT button goes off.

## Adjusting the audio emphasis

You can adjust the audio emphasis using the graphic equalizer and surround effect.

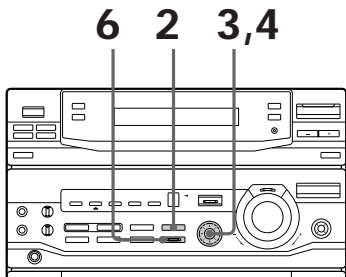

## Adjusting the graphic equalizer

You can adjust the sound by raising or lowering the levels of specific frequency ranges.

Before operation, first select the basic audio emphasis you want for your sound.

- 1 Select the basic audio emphasis you want for your sound (see “Selecting the audio emphasis”).
- 2 Press **GEQ CONTROL**.  
The frequency range appears and the level value flashes in the display.
- 3 Press **GEQ** ◀/▶ repeatedly to select a frequency band.

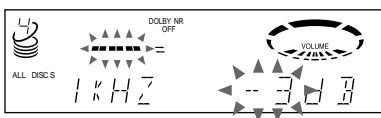

- 4 Press **GEQ** ▲/▼ to adjust the level.

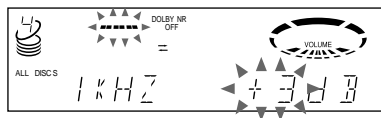

- 5 Repeat steps 3 and 4 to adjust the other frequency bands.
- 6 Press **ENTER** when finished.

### Note

If you choose another audio emphasis (other than “EFFECT OFF”), the adjusted sound effect is lost. To retain the adjusted sound effect for future use, store it in a personal file (see “Making a personal audio emphasis file”).

## Activating the surround effect

You can enjoy the surround effect.

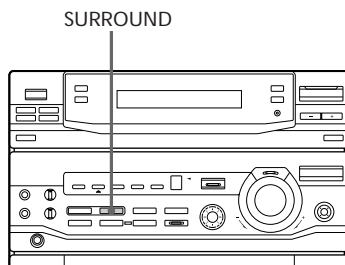

- ➔ Press **SURROUND** so “SUR ((| | | | |))” appears in the display.

### Note

If you choose other sound effects, the surround effect will be canceled. To retain the effect, store it in a personal file (see “Making a personal audio emphasis file”).

---

# Making a personal audio emphasis file

## — Personal File

You can create personal files of audio patterns (surround effect and graphic equalizer) and store them in the unit's memory. Later call up an audio pattern to play a favorite tape, CD, or radio program. You can create up to five audio files. Before operation, first select the basic audio emphasis you want for your sound.

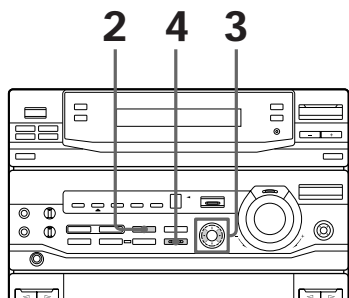

---

**1** Create the sound effect you want by using the graphic equalizer and surround effect (see “Adjusting the audio emphasis”).

---

**2** Press P FILE MEMORY.  
A personal file number appears in the display.

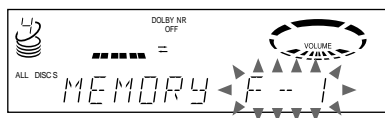

---

**3** Press GEQ ◀/▶ to select the file number (P FILE) where you want to store the sound effect.

---

**4** Press ENTER.  
The adjusted sound effects are stored under the selected file number. Any settings previously stored at this memory location are erased and replaced by the new settings.

---

### To call up the personal file

- 1 Press GEQ ▲/▼ (or MUSIC MENU △/▽ on the remote) repeatedly to select P FILE.
- 2 Press GEQ ◀/▶ (or MUSIC MENU ◀/▶ on the remote) repeatedly to select the desired personal file.

# Mixing and recording sounds

You can “mix” sounds by playing one of the components and singing or speaking into a microphone (not supplied). The mixed sounds can be recorded on a tape.

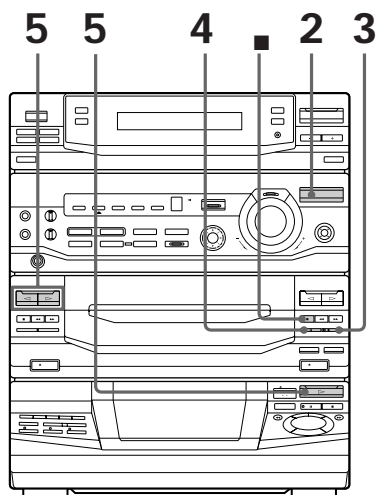

- 1** Prepare the microphone and the karaoke effect. Then, insert a blank tape in deck B.
- 2** Press FUNCTION repeatedly to select the source you desire and set it to pause mode.
- 3** Press ● REC.
- 4** Press II.
- 5** Press ▷ to start playing the CD (or tape in deck A).  
Playback starts.  
Start singing along with the music.

### To stop recording

Press ■ on deck B.

### Tips

- If acoustic feedback (howling) occurs, move the microphone away from the speakers or change the direction of the microphone.
- If you want to record your voice through the microphone only, you can do so by selecting the CD source and not playing a CD.



## Waking up to music (continued)

- 4** Press TUNING +/- to select DAILY 1 or DAILY 2, then press ENTER/NEXT.

“ON” appears and the hour indication flashes in the display.

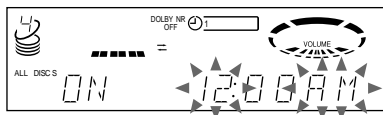

- 5** Set the time to start playback.

Press TUNING +/- to set the hour, then press ENTER/NEXT.

The minutes indication flashes.

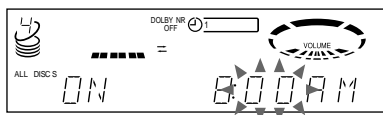

Press TUNING +/- to set the minutes, then press ENTER/NEXT.

The hour indication flashes again.

- 6** Set the time to stop playback following the above procedure.

- 7** Press TUNING +/- until the music source you want appears.

The indication changes as follows:

TUNER → CD PLAY → TAPE PLAY



- 8** Press ENTER/NEXT.

The start time, the stop time, and the music source appear in turn before the original display returns.

- 9** Turn off the system.

## To check the setting

- 1 Press the timer button you have set, DAILY 1 or DAILY 2.
- 2 “TIMER OFF” appears in the display.
- 3 Press DAILY 1 or DAILY 2 again.

## To cancel the timer operation

- 1 Press the timer button you have set, DAILY 1 or DAILY 2.
- 2 “TIMER OFF” appears in the display.

## Notes

- The system turns on 15 seconds before the preset time.
- You cannot activate DAILY 1 and DAILY 2 at the same time.
- You cannot set the timer if the timer on and off times are the same.
- When you set the Sleep Timer, the Wake-up Timer will not turn on the system until the Sleep Timer turns it off.
- You cannot activate the Wake-up Timer and Timer-recording at the same time.



# Timer-recording radio programs

To timer-record, you must preset the radio station (see “Step 3: Presetting radio stations”) and set the clock (see “Step 2: Setting the time”) beforehand.

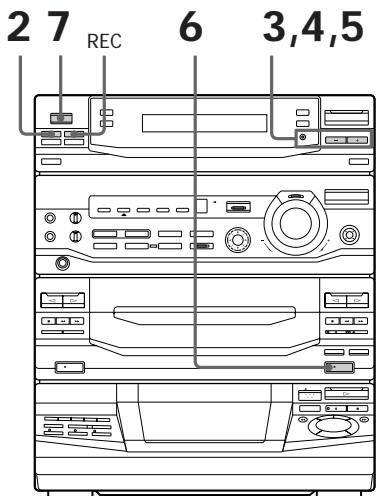

**1** Tune in the preset radio station (see “Listening to the radio”).

**2** Press  $\ominus$ /CLOCK SET. “SET” appears and “DAILY 1” flashes in the display.

**3** Press TUNING +/- to select REC, then press ENTER/NEXT. “ON” appears and the hour indication flashes in the display.

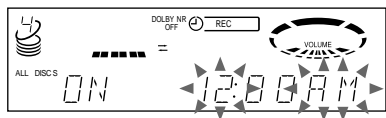

**4** Set the time to start recording. Press TUNING +/- to set the hour, then press ENTER/NEXT. The minutes indication flashes.

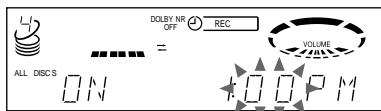

Press TUNING +/- to set the minutes, then press ENTER/NEXT. The hour indication flashes again.

**5** Set the time to stop recording following the above procedure. The start time, the stop time, the recording source, and the preset station appear in turn before the original display returns.

**6** Insert a blank tape in deck B.

**7** Turn off the system. When recording starts, the volume level is set to the minimum.

## To check the setting

- 1 Press REC.
  - 2 “TIMER OFF” appears in the display.
  - 3 Press REC again.
- To change the setting, start over from step 1.

## To cancel the timer operation

- 1 Press REC.
- 2 “TIMER OFF” appears in the display.

## Notes

- The system turns on 15 seconds before the preset time.
- If the system is on at the preset time, the recording will not be made.
- You cannot set the timer if the timer on and off times are the same.
- When you set the Sleep Timer, the Timer-recording will not start until the Sleep Timer turns off the system.
- You cannot activate the Wake-up Timer and Timer-recording at the same time.
- Recording starts from the front side.

## Precautions

### On operating voltage

Before operating the system, check that the operating voltage of your system is identical with the voltage of your local power supply.

### On safety

- The unit is not disconnected from the AC power source (mains) as long as it is connected to the wall outlet, even if the unit itself has been turned off.
- Unplug the system from the wall outlet (mains) if it is not to be used for an extended period of time. To disconnect the cord (mains lead), pull it out by the plug. Never pull the cord itself.
- Should any solid object or liquid fall into the component, unplug the stereo system and have the component checked by qualified personnel before operating it any further.
- The AC power cord must be changed only at the qualified service shop.

### On placement

- Place the stereo system in a location with adequate ventilation to prevent heat build-up in the stereo system.
- Do not place the unit in an inclined position.
- Do not place the unit in locations where it is;
  - Extremely hot or cold
  - Dusty or dirty
  - Very humid
  - Vibrating
  - Subject to direct sunlight

### On operation

- If the stereo system is brought directly from a cold to a warm location, or is placed in a very damp room, moisture may condense on the lens inside the CD player. Should this occur, the system will not operate properly. Remove the CD and leave the system turned on for about an hour until the moisture evaporates.
- When you move the system, take out any discs.

If you have any questions or problems concerning your stereo system, please consult your nearest Sony dealer.

### Notes on CDs

- Before playing, clean the CD with a cleaning cloth. Wipe the CD from the center out.
- Do not use solvents such as benzene, thinner, commercially available cleaners or anti-static spray intended for vinyl LPs.
- Do not expose the CD to direct sunlight or heat sources such as hot air ducts, nor leave it in a car parked in direct sunlight.

### Cleaning the cabinet

Use a soft cloth slightly moistened with mild detergent solution.

### To save a tape permanently

To prevent a tape from being accidentally recorded over, break off the cassette tab from side A or B as illustrated. If you later want to reuse the tape for recording, cover the broken tab with adhesive tape.

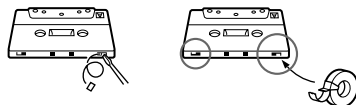

When you are using a TYPE II (CrO<sub>2</sub>) or TYPE IV (metal) cassette, be careful not to cover the detector slots which allow the tape player to automatically detect the type of tape.

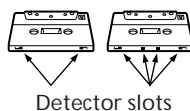

### Before placing a cassette in the tape deck

Take up any slack in the tape. Otherwise the tape may get entangled in the parts of the tape deck and become damaged.

### When using a tape longer than 90 minutes

The tape is very elastic. Do not change the tape operations such as play, stop, and fast-winding etc. frequently. The tape may get entangled in the tape deck.

### Cleaning the tape heads

Clean the tape heads after every 10 hours of use.

When the tape heads become dirty

- the sound is distorted
- there is a decrease in sound level
- the sound drops out
- the tape does not erase completely
- the tape does not record

Make sure to clean the tape heads before you start an important recording or after playing an old tape. Use separately sold dry-type or wet-type cleaning cassette. For details, refer to the instructions of the cleaning cassette.

### Demagnetizing the tape heads

Demagnetize the tape heads and the metal parts that have contact with the tape every 20 to 30 hours of use with a separately sold demagnetizing cassette. For details, refer to the instructions of the demagnetizing cassette.

## **In case color irregularity is observed on nearby a TV screen**

With the magnetically shielded type of speaker system, the speakers can be installed near a TV set. However, color irregularity may still be observed on the TV screen depending on the type of your TV set.

### **If color irregularity is observed...**

Turn off the TV set once, then turn it on after 15 to 30 minutes.

### **If color irregularity is observed again...**

Place the speakers farther away from the TV set.

---

# Troubleshooting

If you run into any problem using this stereo system, use the following checklist.

First, check that the power cord is connected firmly and the speakers are connected correctly and firmly.

Should any problem persist, consult your nearest Sony dealer.

## General

---

**The display starts flashing as soon as you plug in the power cord even though you haven't turned on the system (demonstration mode).**

- Press DISPLAY/DEMO while the system power is off.

The demonstration appears automatically the first time you plug in the power cord, or if there is a power outage lasting longer than half a day.

In this case, reset the following:

- Clock setting (see "Step 2: Setting the time")
  - Press DISPLAY/DEMO while the system is off.
- 

**There is no sound.**

- Turn VOLUME clockwise.
  - The headphones are connected.
  - Insert only the stripped portion of the speaker cord into the SPEAKER jack. Inserting the vinyl portion of the speaker cord will interfere with the speaker connection.
- 

**There is no microphone sound.**

- Turn VOLUME or MIC LEVEL to adjust the microphone volume.
  - Make sure the microphone is connected to the MIC jack correctly.
- 

**There is severe hum or noise.**

- A TV or VCR is placed too close to the stereo system. Move the stereo system away from the TV or VCR.
- 

**"12:00 AM" flashes in the display.**

- A power interruption occurred. Reset the clock and timer settings.
- 

**The timer does not function.**

- Set the clock correctly.

---

**DAILY 1, DAILY 2, and REC do not appear when you press  $\odot$ /CLOCK SET.**

- Set the timer correctly.
- Set the clock.

---

**The remote does not function.**

- There is an obstacle between the remote and the unit.
- The remote is not pointing in the direction of the system's sensor.
- The batteries have run down. Replace the batteries.

---

**There is acoustic feedback.**

- Decrease the volume level.
- Move the microphone away from the speakers or change the direction of the microphone.

---

**The color irregularity on a TV screen persists.**

- Turn off the TV set once, then turn it on after 15 to 30 minutes. If the color irregularity still persists, place the speakers farther away from the TV set.

---

## Speakers

---

**Sound comes from only one channel or the left and right volumes are unbalanced.**

- Check the speaker connections and placement.

---

## Video CD/CD Player

---

**There is no picture.**

- Check that the unit is connected securely.
- Make sure you operate the TV correctly.
- Make sure you set the SYSTEM SELECT correctly, according to your TV (color) system.
- Press FUNCTION repeatedly until "CD" is displayed.

---

**Parts of the picture or the on-screen display menu are out of focus or unclear.**

- Press DNR repeatedly until "DNR OFF" appears.

---

**An after image of the last picture remains the screen, or the picture is unclear.**

- Press ACTIVE/COMET repeatedly until "EFFECT OFF" appears.

---

**The CD tray does not rotate.**

- A CD is not placed properly.

---

**A CD will not play.**

- The CD is not lying flat in the disc tray.
- The CD is dirty.
- The CD is inserted label side down.
- Moisture condensation has built up. Remove the CD and leave the system turned on for about an hour until the moisture evaporates.

---

**Play does not start from the first track.**

- The player is in Program or Shuffle Play mode. Press PLAY MODE repeatedly until "PROGRAM" or "SHUFFLE" disappear from the display.

---

## Tape Deck

---

**The tape does not record.**

- No tape is in the cassette holder.
- The tab has been removed from the cassette (see page 50).
- The tape has reeled to the end.

---

**The tape does not record nor play, or there is a decrease in sound level.**

- The heads are dirty. Clean them (see page 50).
- The record/playback heads are magnetized. Demagnetize them (see page 50).

---

**The tape does not erase completely.**

- The record/playback heads are magnetized. Demagnetize them (see page 50).

---

**There is excessive wow or flutter, or the sound drops out.**

- The capstans or pinch rollers are dirty. Clean them (see page 50).

---

**Noise increases or the high frequencies are missing.**

- The record/playback heads are magnetized. Demagnetize them (see page 50).

## Tuner

Severe hum or noise (“TUNED” or “STEREO” flashes in the display.

- Adjust the antenna.
- The signal strength is too weak. Connect an external antenna.

A stereo FM program cannot be received in stereo.

- Press STEREO/MONO so “STEREO” appears in the display.

**If other problems not described above occur, reset the system as follows:**

- 1 Unplug the power cord.
- 2 Plug the power cord back in.
- 3 Press GROOVE, ENTER/NEXT, and DISC 1 at the same time.

## Specifications

### Amplifier section

Continuous RMS power output  
80 + 80 watts  
(5 ohms at 1 kHz, 10% THD)

Peak music power output 1,200 watts

#### Inputs

PHONO IN (phono jacks): sensitivity 3 mV,  
impedance 47 kilohms

VIDEO (AUDIO) IN (phono jacks):  
sensitivity 250 mV,  
impedance 47 kilohms

MIX MIC (phone jack): sensitivity 1 mV,  
impedance 10 kilohms

#### Outputs

VIDEO (AUDIO) OUT (phono jacks):  
voltage 250 mV,  
impedance 1 kilohms  
VIDEO (phono jack):  
max. output level  
1 Vp-p, unbalanced,  
Sync negative,  
load impedance 75 ohms

S-VIDEO (4-pin/mini-DIN jack):  
Y: 1 Vp-p, unbalanced,  
Sync negative  
C: 0.286 Vp-p,  
load impedance 75 ohms

PHONES (stereo phone jack):  
accepts headphones of 8  
ohms or more

SPEAKER:  
accepts impedance of 5 to  
16 ohms

### Video CD / CD player section

System Compact disc digital  
audio and video system

Laser Semiconductor laser  
( $\lambda = 780 \text{ nm}$ )  
Emission

Laser output duration: continuous  
Max. 44.6  $\mu\text{W}^*$   
\* This output is the value  
measured at a distance of  
200 mm from the  
objective lens surface on  
the Optical Pick-up Block  
with 7 mm aperture.

Wavelength 780 – 790 nm

Frequency response 2 Hz – 20 kHz ( $\pm 0.5 \text{ dB}$ )

Signal-to-noise ratio More than 90 dB

Dynamic range More than 90 dB

Video

Color system format NTSC, PAL

## Tape player section

Recording system	4-track 2-channel stereo
Frequency response (DOLBY NR OFF)	60 – 13,000 Hz ( $\pm 3$ dB), using a Sony TYPE I cassette 60 – 14,000 Hz ( $\pm 3$ dB), using a Sony TYPE II cassette
Wow and flutter	$\pm 0.15\%$ W. Peak (IEC) 0.1% W. RMS (NAB) $\pm 0.2\%$ W. Peak (DIN)

## Tuner section

FM stereo, FM/AM superheterodyne tuner

### FM tuner section

Tuning range	87.5 – 108.0 MHz (50 kHz step)
Antenna	FM wire antenna
Antenna terminals	75 ohm unbalanced
Intermediate frequency	10.7 MHz

### AM tuner section

Tuning range	531 – 1,602 kHz (with the tuning interval set at 9 kHz) 530 – 1,710 kHz (with the tuning interval set at 10 kHz)
Antenna	AM loop antenna, External antenna terminals
Intermediate frequency	450 kHz

## General

Power requirements	220 – 240 V AC, 50/60 Hz
Power consumption	170 watts
Dimensions (w/h/d)	Approx. 355 × 425 × 435 mm incl. projecting parts and controls
Mass	Approx. 12.0 kg
Supplied accessories	AM loop antenna (1) Remote RM-SV4800 (1) Sony SUM-3 (NS) batteries (2) FM wire antenna (1) Speaker cords (2) Video cable (1) Speaker SS-XB3R (2) Rack SU-XB3R (1)

Design and specifications are subject to change  
without notice.

---

# Glossary

## Auto Pause

An automatically pauses according to the signal encoded on the disc while playing a VIDEO CD. If the CD player does not resume play for a long time, press SELECT CD ▷ to resume play manually.

## Menu Playback

Playback using the menu screens recorded on VIDEO CDs with PBC functions. You can enjoy simple interactive software using the menu playback function.

## Playback Control (PBC)

Signals encoded on VIDEO CDs (Version 2.0) to control playback.

By using menu screens recorded on VIDEO CDs with PBC functions, you can enjoy playing simple interactive software, software with search functions, and so on.

When you select a VIDEO CD with PBC functions on this player, the PBC indicator lights up.

## Track

Sections of a picture or a music piece on disc. Each track is assigned a track number to help you locate the track you want.

## VIDEO CD

A compact disc which contains moving pictures.

VIDEO CDs contain compact picture information using the MPEG 1 format, one of the world wide standards of digital compact technology. The picture information is compressed about 120 times. Consequently, a 12 cm VIDEO CD can contain up to 74 minutes of moving pictures.

VIDEO CDs also contain compact audio information. Sounds outside the range of human hearing are compressed while the sounds we can hear are not compressed. VIDEO CDs can hold six times the audio information of conventional audio CDs.

There are two versions for VIDEO CDs:

Version 1.1 (VIDEO CDs without PBC functions):

You can play only moving pictures and sounds.

Version 2.0 (VIDEO CDs with PBC functions):

You can play still pictures and enjoy PBC functions.

This player can play to both versions.

# Index

## A

- Active Picture 32
- Adjusting
  - the audio emphasis 44
  - the on-screen display 24
  - the sound 42
  - the volume 11, 13, 15, 18
- Advanced DNR 31
- Antennas 4, 9
- Audio emphasis 43, 44
- Automatic Source Selection 13, 15, 18

## B

- Batteries 5

## C

- CD Flash 40
- CD Loop 40
- CD Non-Stop Play 36
- CD Synchro Recording 14
- Clock setting 6
- COMET 32
- Connecting. *See* Hooking up

## D, E, F, G

- Display 5, 23, 43
- Dubbing 19

## H, I, J

- Hooking up
  - optional components 8
  - the antennas 4, 9
  - the power 5
  - the system 4

## K, L

- Karaoke 20
  - to adjust the key 21
  - to adjust the microphone echo 21
  - to reduce the vocals (KARAOKE PON) 20
  - to sing along with a multiplex CD or tape (MPX R/MPX L) 20

## M

- Microphone
  - mixing 46
- Mixing sound 46

## N

- Normal Play 12

## O

- One Touch Play 13, 15, 18

## P, Q

- Personal File 45
- Playing
  - a CD 12
  - a preset radio station 15
  - a tape 17
  - a VIDEO CD 10
  - tracks in random order (Shuffle Play) 33
  - tracks in the desired order (Program Play) 34
  - tracks repeatedly (Repeat Play) 33
  - without interruption 36
- Presetting radio stations 7
- Preset tuning 15
- Program Edit 38
- Program Play 34
- Protecting recordings 50

## R

- Radio stations
  - presetting 7
  - tuning in 15

## Recording

- a CD/VIDEO CD 14
- a radio program 16
- a tape manually 37
- another tape 19
- CDs by specifying the track order 38
- selecting tape length automatically 39
- timer recording 49
- Repeat Play 33
- Resetting the system 53

## S

- Saving recordings 50
- Searching
  - Index Search 27
  - Scene Search 26
  - Time Search 28
- Selecting
  - the audio emphasis 43
  - the color system 5
- Setting the time 6
- Shuffle Play 33
- Sleep Timer 47
- Sound adjustment 42
- Speakers 4
- Surround effect 44

## T, U

- Tape Select Edit 39
- Timer
  - falling asleep to music 47
  - timer recording 49
  - waking up to music 47
- Troubleshooting 51
- Tuner 7, 15, 16
- Tuning interval 7
- Turntable 8

## V

- VIDEO CD/CD player 10, 12, 22

## W, X, Y, Z

- Wake-up timer 47
- Wave 41