

Video Cassette Recorder

Operating Instructions



SLV-478

WARNING

To prevent fire or shock hazard, do not expose the unit to rain or moisture.

To avoid electrical shock, do not open the cabinet. Refer servicing to qualified personnel only.

CAUTION

To prevent electric shock, do not use this polarized AC plug with an extension cord, receptacle or other outlet unless the blades can be fully inserted to prevent blade exposure.

Precautions

Safety

- Operate the unit only on 120 V AC, 60 Hz.
- If anything falls into the cabinet, unplug the unit and have it checked by qualified personnel before operating it any further.
- One blade of the plug is wider than the other for the purpose of safety and will fit into the power outlet only one way. If you are unable to insert the plug fully into the outlet, contact your Sony dealer.
- Unplug the unit from the wall outlet if you do not intend to use it for an extended period of time. To disconnect the cord, pull it out by the plug, never by the cord.

Installing

- Allow adequate air circulation to prevent internal heat buildup.
- Do not place the unit on surfaces (rugs, blankets, etc.) or near materials (curtains, draperies) that may block the ventilation slots.
- Do not install the unit near heat sources such as radiators or air ducts, or in a place subject to direct sunlight, excessive dust, mechanical vibration or shock.
- Do not install the unit in an inclined position. It is designed to be operated in a horizontal position only.
- Keep the unit and cassettes away from equipment with strong magnets, such as microwave ovens or large loudspeakers.
- Do not place heavy objects on the unit.
- If the unit is brought directly from a cold to a warm location, moisture may condense inside the VCR and cause damage to the video head and tape. When you first install the unit, or when you move it from a cold to a warm location, wait for about one hour before operating the unit.

Caution

Television programs, films, video tapes and other materials may be copyrighted. Unauthorized recording of such material may be contrary to the provisions of the copyright laws. Also, use of this recorder with cable television transmission may require authorization from the cable television transmission and/or program owner.

Table of contents

Getting Started

- 4 Step 1: Unpacking
- 5 Step 2: Setting up the remote commander
- 7 Step 3: Hookups
- 17 Selecting a language
- 18 Setting the clock
- 20 Presetting channels

Basic Operations

- 26 Playing a tape
- 28 Recording TV programs
- 31 Recording TV programs using the timer

Additional Operations

- 34 Playing/searching at various speeds
- 35 Recording TV programs using the quick timer
- 36 Checking/changing/canceling timer settings
- 38 Adjusting the picture
- 39 Changing menu options
- 40 Editing with another VCR

Additional Information

- 42 General setup information
- 44 Troubleshooting
- 46 Specifications
- 47 Index to parts and controls
- 51 Index
- back cover
- Quick reference to using the VCR

Step 1

Unpacking

Check that you have received the following items with the VCR:

- Remote commander

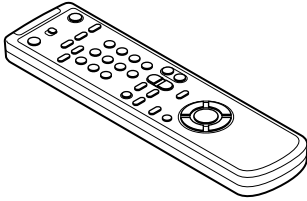

- 75-ohm coaxial cable with F-type connectors

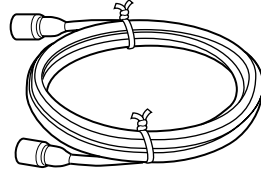

- Size AA (R6) batteries

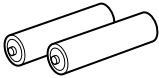

Step 2

Setting up the remote commander

Inserting the batteries

Insert two size AA (R6) batteries by matching the + and - on the batteries to the diagram inside the battery compartment.

Insert the negative (-) end first, then push in and down until the positive (+) end clicks into position.

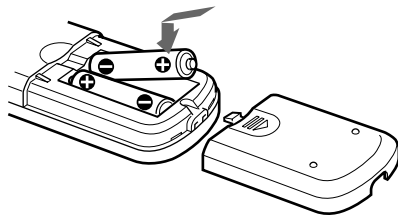

Using the remote commander

You can use this remote commander to operate this VCR and a Sony TV. Buttons on the remote commander marked with a dot (•) can be used to operate your Sony TV.

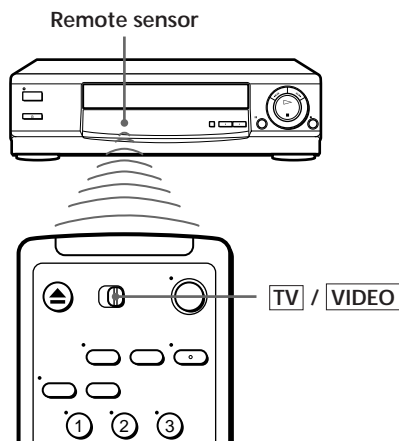

To operate	Set TV / VIDEO to
the VCR	VIDEO and point at the remote sensor on the VCR
a Sony TV	TV and point at the remote sensor on the TV

Notes

- With normal use, the batteries should last about three to six months.
- If you do not use the remote commander for an extended period of time, remove the batteries to avoid possible damage from battery leakage.
- Do not use a new battery with an old one.
- Do not use different types of batteries.

continued

Step 2: Setting up the remote commander (continued)

Controlling other TVs with the remote commander

The remote commander is preprogrammed to control non-Sony TVs. If your TV is listed in the table below, set the appropriate manufacturer's code number.

- 1 Set **TV**/**VIDEO** at the top of the remote commander to **TV**.
- 2 Hold **POWER** down, and enter your TV's code number(s) using the number buttons. Then release **POWER**.

Now you can use the **POWER**, **VOL +/-**, **CH +/-** and **TV/VIDEO** buttons to control your TV. You can also use the buttons marked with a dot (•) to control a Sony TV. To control the VCR, reset **TV**/**VIDEO** to **VIDEO**.

Code numbers of controllable TVs

If more than one code number is listed, try entering them one at a time until you find the one that works with your TV.

Manufacturer	Code number	Manufacturer	Code number	Manufacturer	Code number
Sony	01	JVC	09	RCA	04,10
Akai	04	KMC	03	Sampo	12
AOC	04	Magnavox	03,08,12	Sanyo	11
Centurion	12	Marantz	04,13	Scott	12
Coronado	03	MGA/Mitsubishi	04,12,13,17	Sears	07,10,11
Curis-Mathes	12	NEC	04,12	Sharp	03,05,18
Daytron	12	Panasonic	06,19	Sylvania	08,12
Emerson	03,04,14	Philco	03,04	Teknika	03,08,14
Fisher	11	Philips	08	Toshiba	07
General Electric	06,10	Pioneer	16	Wards	03,04,12
Gold Star	03,04,17	Portland	03	Yorx	12
Hitachi	02,03	Quasar	06,18	Zenith	15
J.C.Penny	04,12	Radio Shack	05,14		

Notes

- If the TV uses a different remote control system from the one programmed to work with the VCR, you cannot control your TV with the remote commander.
- If you enter a new code number, the code number previously entered will be erased.
- When you replace the batteries of the remote commander, the code number automatically resets to 01 (Sony). Reset the appropriate code number.

Step 3

Hookups

Selecting the best hookup option

There are many ways in which your VCR can be hooked up. To hook up your VCR so that it works best for you, first scan through the table below. Then use the accompanying diagrams and procedures on the following pages to set up your VCR.

If you have	Use	Refer to
TV that has audio/video input	Audio/video (A/V) hookup, then follow one of the hookups below.	Page 8
Antenna only, no cable TV	Hookup 1	Pages 9 and 10
Cable box with many scrambled channels	Hookup 2	Pages 11 and 12
No cable box or cable box with only a few scrambled channels	Hookup 3	Pages 13 and 14
Cable box with only a few scrambled channels, using an A/B switch	Hookup 4	Pages 15 and 16

After you've completed the connections, follow the instructions for setup. During setup, if you need more details on the procedure described, page numbers are provided where you can find complete, step-by-step instructions.

After you've completed the setup, you're ready to use your VCR. Procedures differ depending on the hookup you used. For an overview, refer to "Quick reference to using the VCR" on the back cover.

Before you get started

- Turn off the power to all equipment.
- Do not connect the AC power cords until all of the connections are completed.
- Be sure you make connections firmly. Loose connections may cause picture distortion.
- If your TV doesn't match any of the examples provided, see your nearest Sony dealer or qualified technician.

Caution

Connections between the VCR's VHF/UHF connector and the antenna terminals of the TV receiver should be made only as shown in the following instructions. Failure to do so may result in operation that violates the regulations of the Federal Communications Commission regarding the use and operation of RF devices. Never connect the output of the VCR to an antenna or make simultaneous (parallel) antenna and VCR connections at the antenna terminals of your receiver.

Step 3: Hookups (continued)

Audio/video (A/V) hookup

Page 8

If your TV has audio/video (A/V) input jacks, you will get a better picture and sound when you hook up your VCR using these connections. If your TV doesn't have A/V inputs, see the following pages for antenna or cable hookups.

If you're not planning to use your VCR to record programs, you're finished setting up the VCR after you've made the connections shown on this page. If you want to record off-air or off your cable TV system, complete these connections first, and then go to the following pages for antenna or cable hookups.

A Use this hookup if your TV has stereo jacks

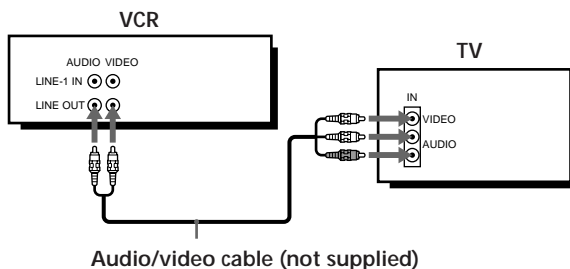

B Use this hookup if your TV doesn't have stereo jacks

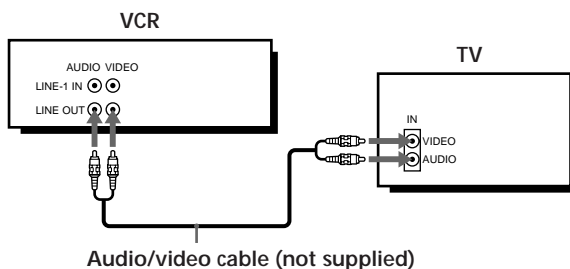

Antenna hookup

Make the following connections if you're using an antenna (if you don't have cable TV).

A Use this hookup if you're using:

- VHF/UHF antenna (you get channels 2–13 and channels 14 and higher)
- UHF-only antenna (you get channels 14 and higher)
- Separate VHF and UHF antennas

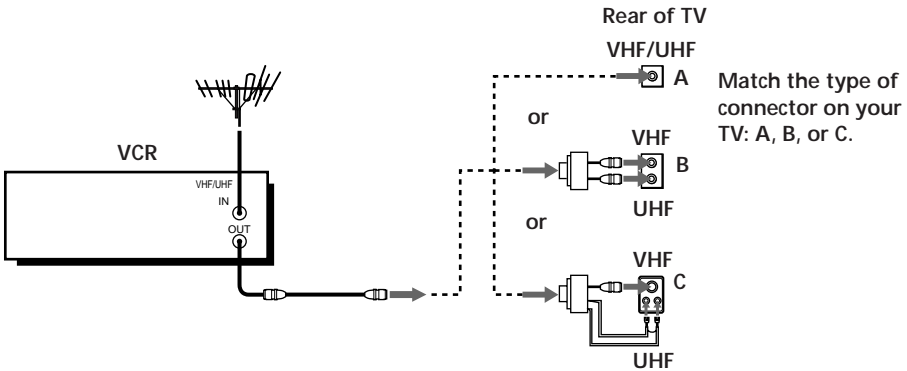

B Use this hookup if you're using a VHF-only antenna (you get channels 2–13 only)

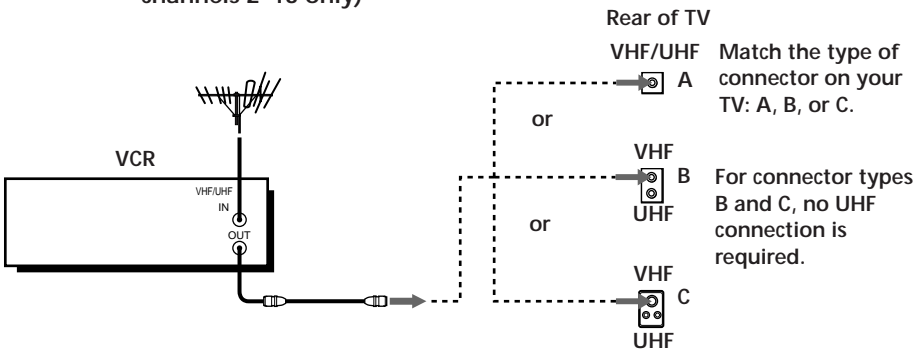

If you cannot connect your antenna cable to the VCR directly

If your antenna cable is a flat cable (300-ohm twin lead cable), attach an external antenna connector (not supplied) so you can connect the cable to the VHF/UHF IN connector. If you have separate cables for VHF and UHF antennas, you should use a U/V band mixer (not supplied). For details, see page 43.

continued

Step 3: Hookups (continued)

Hookup 1: VCR setup

- 1 Set the RF UNIT switch to CH 3 or CH 4, whichever channel is not used in your area. If both are used, set the switch to either channel.

For details, see page 42. If you made A/V connections (page 8), you can skip this step.

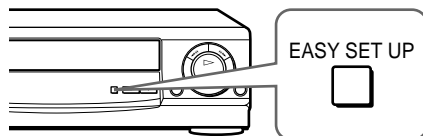
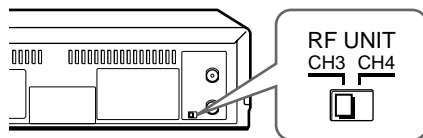

- 2 Press EASY SET UP on the VCR.

- 1 The LANGUAGE menu appears. Change the on-screen display language to Spanish (ESPAÑOL) or French (FRANÇAIS) if desired, and press OK. For details, see page 17.

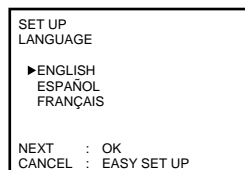

- 2 The CLOCK SET menu appears. Set the clock and press OK. For details, see page 18.

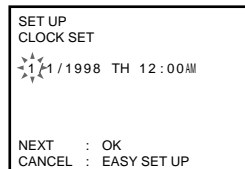

- 3 The TUNER PRESET menu appears. Set ANTENNA/CABLE to ANT and press OK. For details, see page 20.

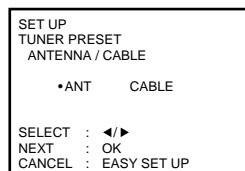

- 4 The AUTO PRESET starts.

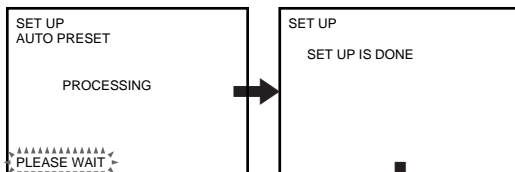

Normal display

Cable box with many scrambled channels

Recommended use

Use this hookup if your cable system scrambles all or most channels.

What you can do with this hookup

- Record any channel by selecting the channel on the cable box

What you can't do

- Record one channel while watching another channel

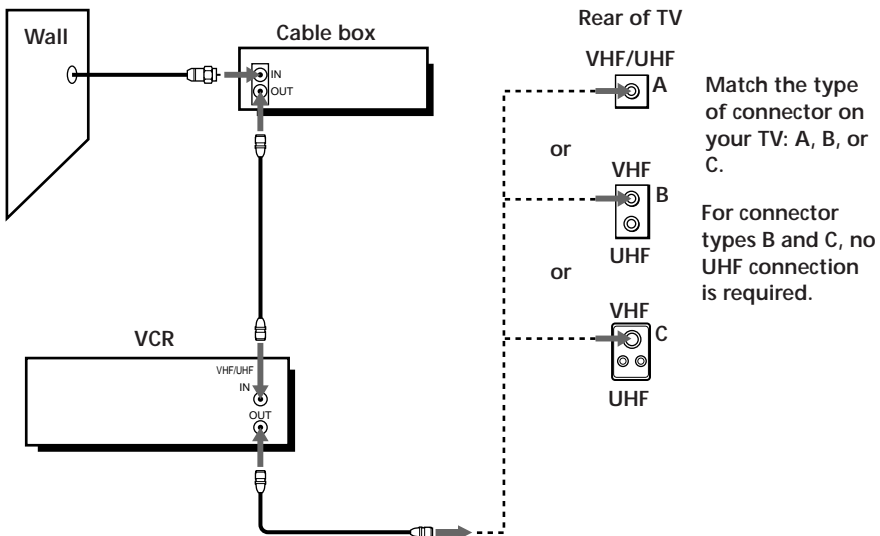

continued

Step 3: Hookups (continued)

Hookup 2: VCR setup

- 1 Set the RF UNIT switch to CH 3 or CH 4, whichever channel is not used in your area. If both are used, set the switch to either channel.

For details, see page 42. If you made A/V connections (page 8), you can skip this step.

- 2 Turn on your cable box.
- 3 Press EASY SET UP on the VCR.

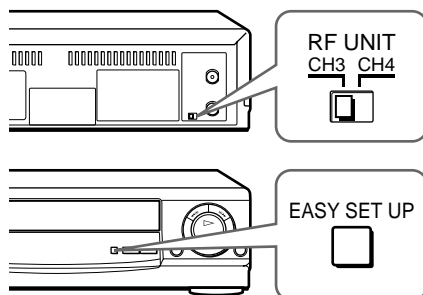

- 1 The LANGUAGE menu appears. Change the on-screen display language to Spanish (ESPAÑOL) or French (FRANÇAIS) if desired, and press OK. For details, see page 17.

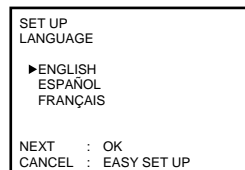

- 2 The CLOCK SET menu appears. Set the clock and press OK. For details, see page 18.

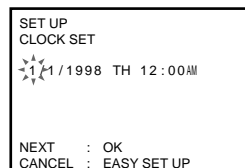

- 3 The TUNER PRESET menu appears. Set ANTENNA/CABLE to ANT and press OK. For details, see page 20.

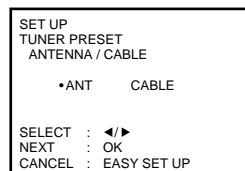

- 4 The AUTO PRESET starts.

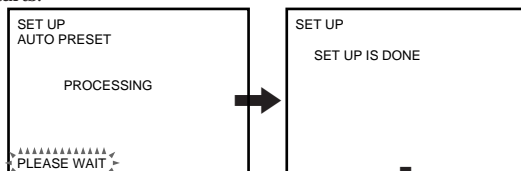

No cable box, or cable box with only a few scrambled channels

Recommended use

Use this hookup if you do not have a cable box. Also use this hookup if your cable system scrambles only a few channels.

What you can do with this hookup

- Record any unscrambled channel by selecting the channel on the VCR

What you can't do

- Record scrambled channels that require a cable box

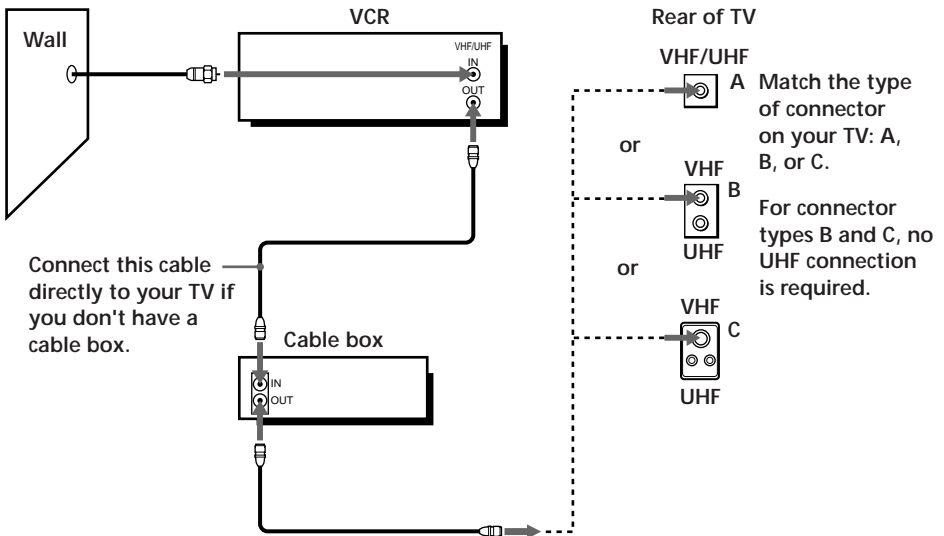

continued

Step 3: Hookups (continued)

Hookup 3: VCR setup

- 1 Set the RF UNIT switch to CH 3 or CH 4, whichever channel is not used in your area. If both are used, set the switch to either channel.

For details, see page 42. If you made A/V connections (page 8), you can skip this step.

- 2 Turn on your cable box.
- 3 Press EASY SET UP on the VCR.

- 1 The LANGUAGE menu appears. Change the on-screen display language to Spanish (ESPAÑOL) or French (FRANÇAIS) if desired, and press OK. For details, see page 17.

- 2 The CLOCK SET menu appears. Set the clock and press OK. For details, see page 18.

- 3 The TUNER PRESET menu appears. Set ANTENNA/CABLE to CABLE and press OK. For details, see page 20.

- 4 The AUTO PRESET starts.

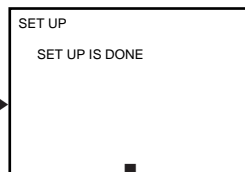
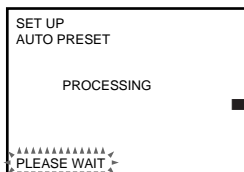
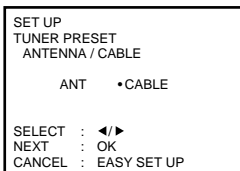
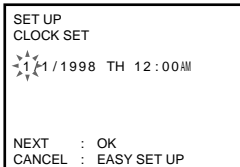
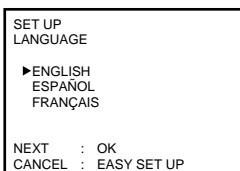
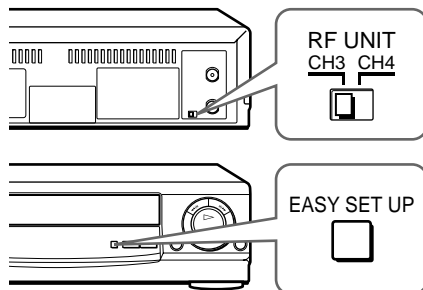

Normal display

Cable box with only a few scrambled channels, using an A/B switch

Recommended use

By using an A/B switch (not supplied), this hookup allows you to record both scrambled and unscrambled channels conveniently.

What you can do with this hookup

- Record any unscrambled channel by selecting the channel directly on the VCR (the A/B switch is set to A)
- Record any scrambled channel by selecting the channel on the cable box (the A/B switch is set to B)

What you can't do

- Record one scrambled channel while watching another channel (the A/B switch is set to B)

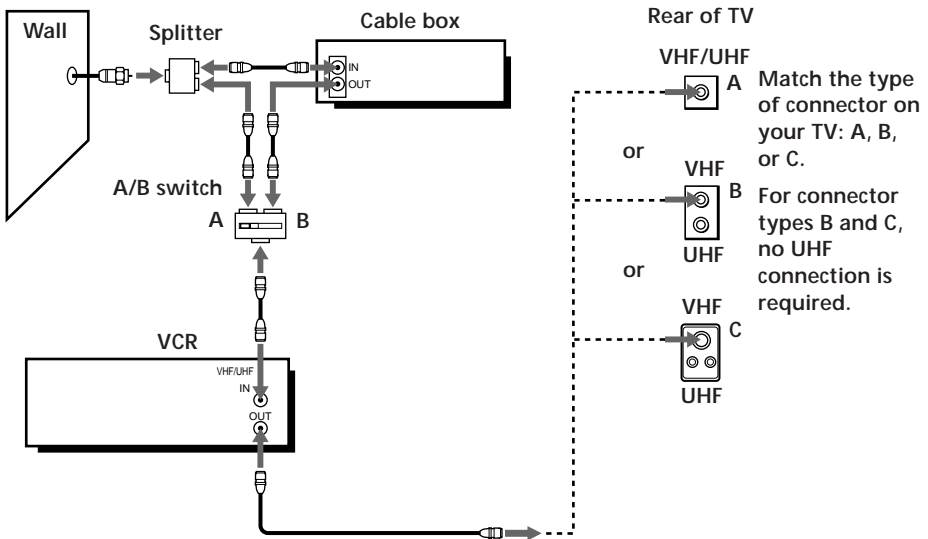

continued

Step 3: Hookups (continued)

Hookup 4: VCR setup

- 1 Set the RF UNIT switch to CH 3 or CH 4, whichever channel is not used in your area. If both are used, set the switch to either channel.

For details, see page 42. If you made A/V connections (page 8), you can skip this step.

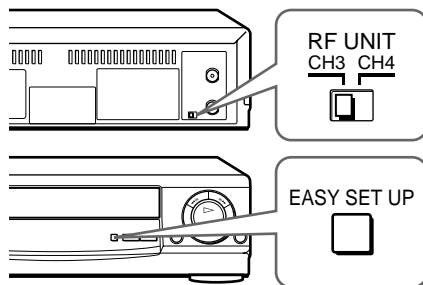

- 2 Set the A/B switch to "A."
- 3 Press EASY SET UP on the VCR.

- 1 The LANGUAGE menu appears. Change the on-screen display language to Spanish (ESPAÑOL) or French (FRANÇAIS) if desired, and press OK. For details, see page 17.

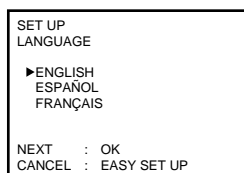

- 2 The CLOCK SET menu appears. Set the clock and press OK. For details, see page 18.

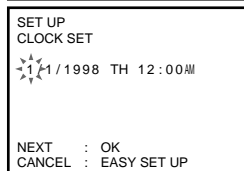

- 3 The TUNER PRESET menu appears. Set ANTENNA/CABLE to CABLE and press OK. For details, see page 20.

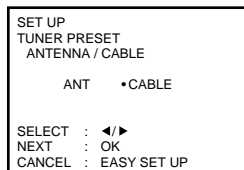

- 4 The AUTO PRESET starts.

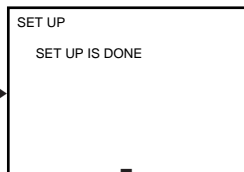
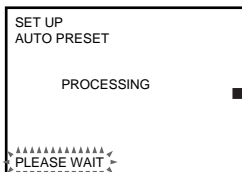

Normal display

Cable box output channel

- 4 Preset the cable box output channel (usually 2, 3 or 4). For details, see page 22.

- 1 Press MENU and select TUNER PRESET.
- 2 Enter the cable box output channel.
- 3 Set MANUAL SET to ADD and press OK.

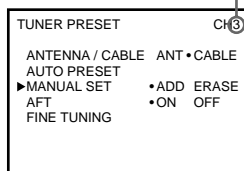

Selecting a language

You can change the on-screen display language.

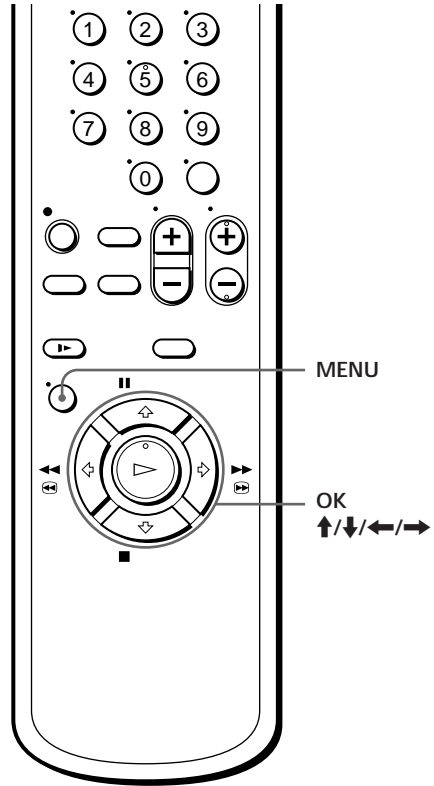

1

• MENU



Press MENU, then press **↑/↓** to move the cursor (▶) to LANGUAGE and press OK.



When using the EASY SET UP procedure, skip this step.

LANGUAGE

▶ ENGLISH
ESPAÑOL
FRANÇAIS

2



Press **↑/↓** to select ENGLISH, ESPAÑOL, or FRANÇAIS, then press OK.

Setting the clock

Set the time and date to use the timer feature for recording programs.

Before you start...

- Turn on the VCR and the TV.
- Set the TV to the VCR channel (channel 3 or 4). If your TV is connected to the VCR using A/V connections, set the TV to video input.
- Press TV/VIDEO to display the VIDEO indicator in the VCR's display window.

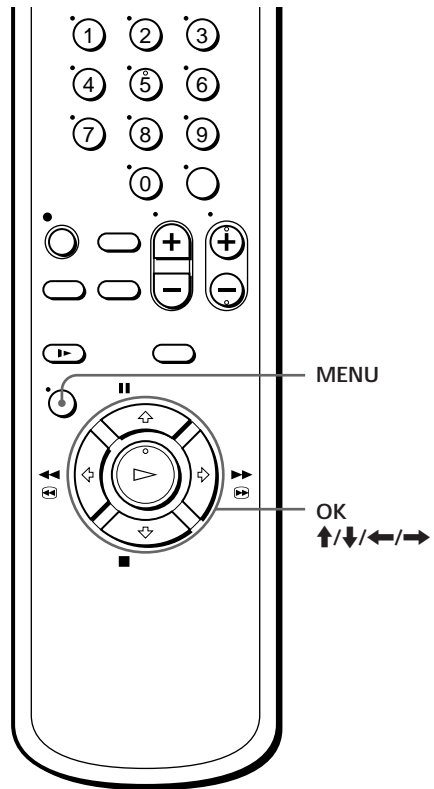

Press MENU, then press **↑/↓** to move the cursor (▶) to CLOCK SET and press OK.



When using the EASY SET UP procedure, skip this step.

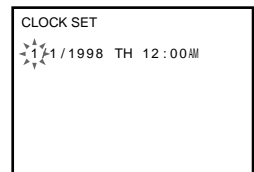

Press **↑/↓** to set the month.

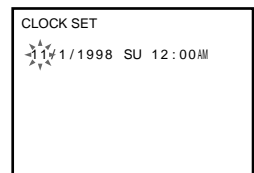

3



Press **→** to flash the day and press **↑/↓** to set the day.
The day of the week is set automatically.

CLOCK SET

11 **→** 6 **↑** 1998 MO 12:00AM

4



Set the year, hour, and minutes in the same way as the day.

5



Press OK to start the clock.

Presetting channels

This VCR is capable of receiving VHF channels 2 to 13, UHF channels 14 to 69 and unscrambled CATV channels 1 to 125. First, we recommend that you preset the receivable channels in your area using automatic presetting. Then, if there are any unwanted channels, disable them manually. If you have decided which channels you wish to preset, set them directly using manual presetting.

Before you start...

- Turn on the VCR and the TV.
- Set the TV to the VCR channel (channel 3 or 4). If your TV is connected to the VCR using A/V connections, set the TV to video input.
- Press TV/VIDEO to display the VIDEO indicator in the VCR's display window.

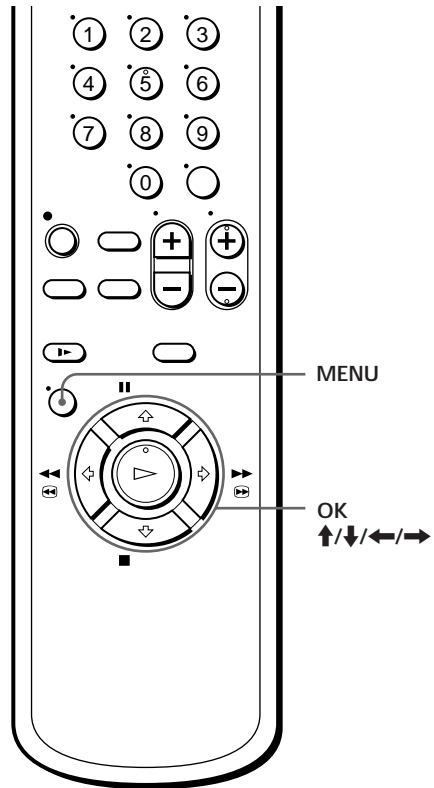

Presetting all receivable channels automatically

- 1** •MENU
- Press MENU, then press \uparrow/\downarrow to move the cursor (\blacktriangleright) to TUNER PRESET and press OK.



When using the EASY SET UP procedure, skip this step.

TUNER PRESET	CH1
ANTENNA / CABLE	ANT • CABLE
AUTO PRESET	
▶MANUAL SET	•ADD ERASE
AFT	•ON OFF
FINE TUNING	

- 2** Press \uparrow/\downarrow to select ANTENNA/CABLE.



3



- To preset cable TV channels:

Press \leftarrow/\rightarrow to set ANTENNA/CABLE to CABLE.

TUNER PRESET	CH1
▶ANTENNA / CABLE	ANT •CABLE
AUTO PRESET	
MANUAL SET	•ADD ERASE
AFT	•ON OFF
FINE TUNING	

- To preset VHF and UHF channels:

Press \leftarrow/\rightarrow to set ANTENNA/CABLE to ANT.



TUNER PRESET	CH2
▶ANTENNA / CABLE	•ANT CABLE
AUTO PRESET	
MANUAL SET	•ADD ERASE
AFT	•ON OFF
FINE TUNING	

4



Press \uparrow/\downarrow to select AUTO PRESET, then press OK.

All receivable channels are preset in numerical sequence. When no more receivable channels can be found, presetting stops and the picture from the lowest numbered channel is displayed on the TV screen.

TUNER PRESET	CH2
ANTENNA / CABLE	•ANT CABLE
▶AUTO PRESET	
MANUAL SET	•ADD ERASE
AFT	•ON OFF
FINE TUNING	
***** * PLEASE WAIT * *****	

continued

Presetting channels (continued)

Presetting/disabling channels manually

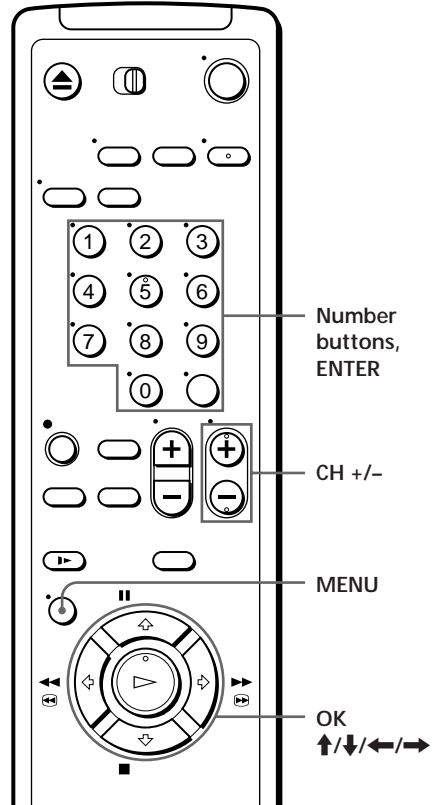

Press MENU and select TUNER PRESET, then press OK.

TUNER PRESET	CH1
ANTENNA / CABLE	ANT • CABLE
AUTO PRESET	
▶ MANUAL SET	• ADD ERASE
AFT	• ON OFF
FINE TUNING	

2

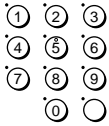

- To preset a channel:

- 1 Press the number buttons to enter the channel number, then press ENTER.
- 2 Press \leftarrow/\rightarrow to set MANUAL SET to ADD.

Channel to be preset

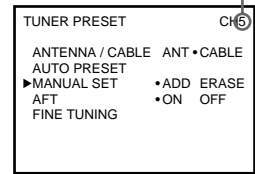

- To disable a channel:

- 1 Press CH +/- to select the channel number.
- 2 Press \leftarrow/\rightarrow to set MANUAL SET to ERASE.

• CH



Channel to be disabled

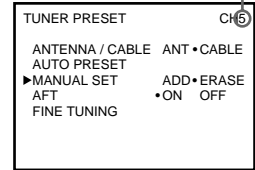

3



- Repeat step 2 to preset or disable channels as required, then press OK.

continued

Presetting channels (continued)

If the picture is not clear

Normally, the Auto Fine Tuning (AFT) function automatically tunes in channels clearly. If, however, the picture of a channel is not clear, you can also use the manual tuning function.

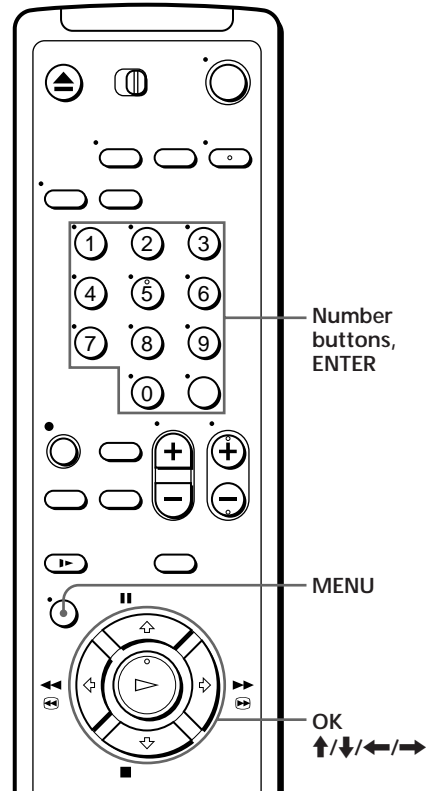

Press MENU and select TUNER PRESET, then press OK.

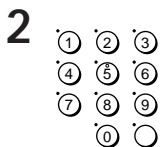
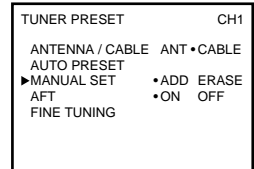

Press the number buttons to select the channel you want to fine-tune, then press ENTER.

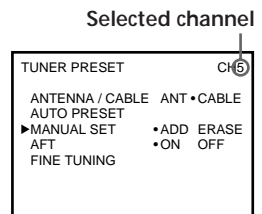

3



Press **↑/↓** to select FINE TUNING.
The fine tuning meter appears.

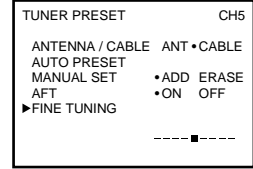

4



Press **←/→** to adjust to a clearer picture,
then press OK.
Note that the AFT setting switches to OFF.

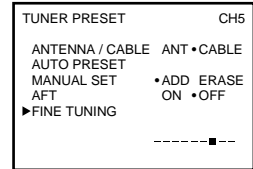

Tip

- To select the channel in step 2 above, you can also use the CH +/- buttons. In this case, you don't need to press ENTER.

Playing a tape

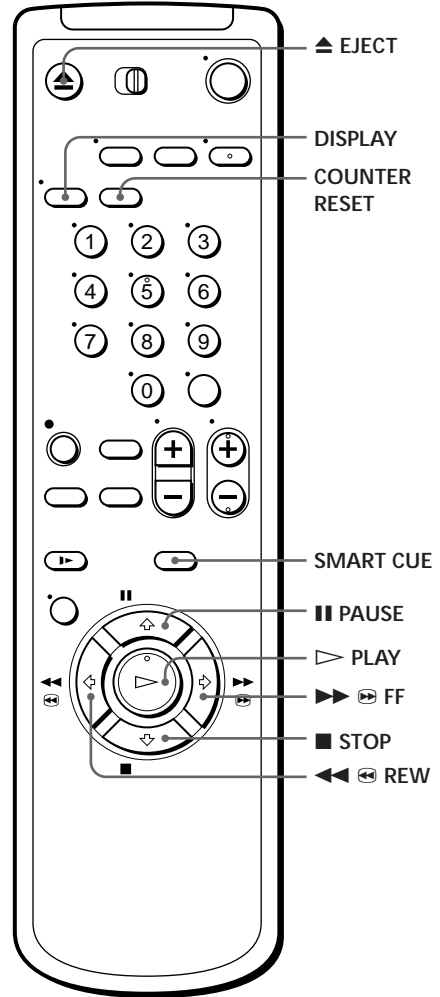

1 Turn on your TV and set it to the video channel.

2 Insert a tape.
The VCR turns on and starts playing automatically if you insert a tape with its safety tab removed.

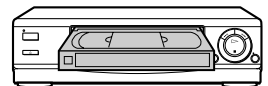

3



Press \triangleright PLAY.

When the tape reaches the end, it will rewind automatically.

Additional tasks

To	Press
Stop play	■ STOP
Pause play	PAUSE
Resume play after pause	PAUSE or \triangleright PLAY
Fast-forward the tape	\blacktriangleright \blacktriangleright FF during stop
Rewind the tape	\blacktriangleleft \blacktriangleleft REW during stop
Eject the tape	\blacktriangle EJECT

To skip playback

You can skip a portion of playback you don't want to watch such as a commercial and restart playback by pressing a single button.

Press SMART CUE during playback of the scene you want to skip. The VCR starts searching.

Press SMART CUE again when you find the scene you want to watch. The VCR stops searching, rewinds a few seconds, then resumes normal playback.

To use the time counter

At the point on the tape that you want to find later, press COUNTER RESET. The counter in the display window resets to "0:00:00." Search for the point afterwards by referring to the counter.

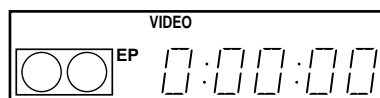

To display the counter on the TV screen, press DISPLAY.

Notes

- Tapes recorded in the LP mode on other VCRs can be played back on this VCR but the picture quality cannot be guaranteed.
- While setting the menu on the TV screen, you cannot use the \triangleright PLAY, || PAUSE, \blacktriangleright \blacktriangleright FF, \blacktriangleleft \blacktriangleleft REW, or ■ STOP buttons.
- The counter resets to "0:00:00" whenever a tape is reinserted.
- The counter stops counting when it comes to a portion with no recording.

Recording TV programs

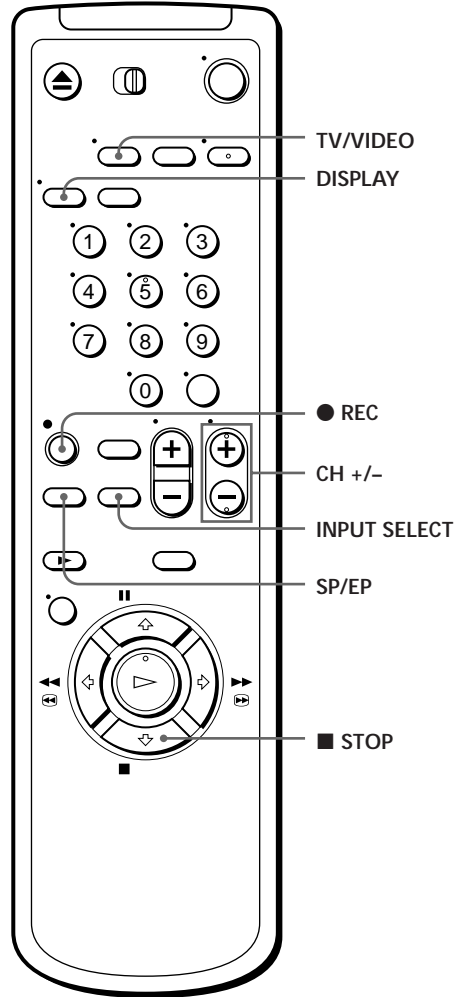

1 Turn on your TV and set it to the video channel.
To record from a cable box, turn it on.

2 Insert a tape with its safety tab in place.

3



Press INPUT SELECT until a channel number appears in the display window.



4



Press CH +/- to select the channel you want to record.

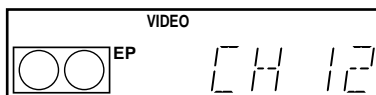

5



Press SP/EP to select the tape speed, SP or EP.

EP (Extra Play) provides recording time three times as long as SP (Standard Play), however, SP produces better picture and audio quality.

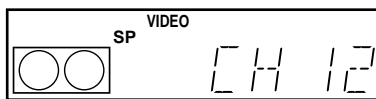

6



Press ● REC to start recording.

The recording indicator lights up red in the display window.

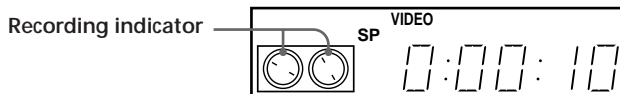

To stop recording

Press ■ STOP.

continued

Recording TV programs (continued)

To check the remaining tape length

Press DISPLAY. The white bar indicates the approximate length of tape remaining.

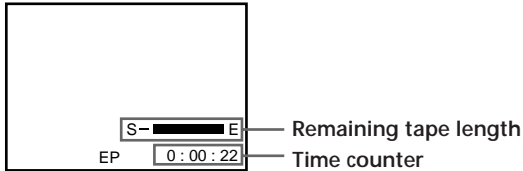

To watch another TV program while recording

- 1 Press TV/VIDEO to turn off the VIDEO indicator in the display window.
- 2 If the TV is connected to the VCR's LINE OUT jacks, set the TV to TV input; if not, skip this step.
- 3 Select another channel on the TV.

To save a recording

To prevent accidental erasure, break off the safety tab as illustrated. To record on a tape again, cover the tab hole with adhesive tape.



Tips

- To select a channel, you can use the number buttons on the remote commander. Enter the channel number, then press ENTER.
- You can select a video source from the LINE-1 IN jacks using the INPUT SELECT button.
- The display appears on the TV screen indicating information about the tape, but the information won't be recorded on the tape.
- If you don't want to watch TV while recording, you can turn off the TV. When using a cable box, make sure to leave it on.

Notes

- The remaining tape length may not be indicated accurately for short tapes such as T-20 or T-30, or tapes recorded in the LP mode.
- The display doesn't appear during still (pause) mode, search mode or slow-motion playback.
- It may take up to one minute for the VCR to calculate and display the remaining tape length after you press DISPLAY.

Recording TV programs using the timer

You can preset up to eight programs at a time.

Before you start...

- Check that the VCR clock is set to the correct time.
- Turn on your TV and set it to the video channel. When using a cable box, turn it on.
- Insert a tape with its safety tab in place. Make sure the tape is longer than the total recording time.

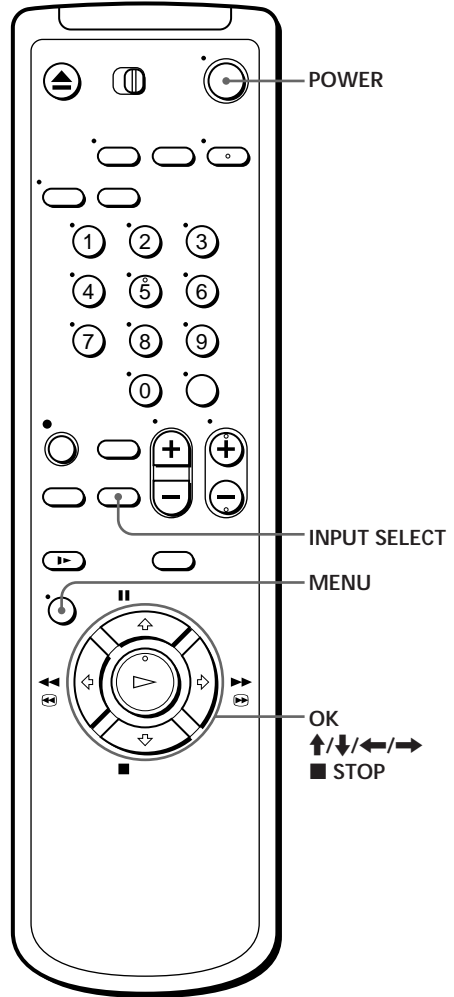

1

• MENU



Press MENU and select **TIMER SET/CHECK**, then press OK.



TIMER SET / CHECK	11 / 16	MO	
DATE	START	STOP	CH
▶ / - / -	- : -	- : -	- -
- / - / -	- : -	- : -	- -
- / - / -	- : -	- : -	- -
- / - / -	- : -	- : -	- -
- / - / -	- : -	- : -	- -
- / - / -	- : -	- : -	- -
- / - / -	- : -	- : -	- -

continued

Recording TV programs using the timer (continued)

2



Set the date, start and stop times, channel number and tape speed:

1 Press **→** to flash each item in turn.

2 Press **↑/↓** to set each item.

To correct a setting, press **←** to return to that setting and reset.

TIMER SET / CHECK	11 / 16	MO	
DATE	START	STOP	CH
11 / 16 MO	---	---	---
XXXXXXXX	---	---	---
- / -	---	---	---
- / -	---	---	---
- / -	---	---	---
- / -	---	---	---
- / -	---	---	---

To record the same program every day or the same day every week, press **↓** while the date is flashing. For details, see “Daily/weekly recording” on this page.



To record from a source connected to the LINE-1 IN jacks, press INPUT SELECT to display “L” in the “CH” position.

3



Press **→** to confirm the setting.

The cursor (▶) appears at the beginning of the line. To enter another setting, move the cursor to the next line and repeat step 2.

4



Press OK.

5



Press POWER to turn off the VCR.

The  indicator appears in the display window and the VCR stands by for recording. When using a cable box, leave it on.

To stop recording

To stop the VCR while recording, press **■** STOP.

Daily/weekly recording

In step 2 above, press **↓** to select the recording pattern. Each time you press **↓**, the indication changes as shown below. Press **↑** to change the indication in reverse order.

the current date → SU-SA → MO-SA → MO-FR → EVERY SA → →
 EVERY MO → EVERY SU → 1 month later → (dates count down) → the
 current date

To use the VCR after setting the timer

To use the VCR before a timer recording begins, just press POWER. The ☺ indicator turns off and the VCR switches on. Remember to press POWER to reset the VCR in timer recording standby after using the VCR.

You can also do the following tasks while the VCR is recording:

- Reset the counter.
- Display tape information on the TV screen.
- Check the timer settings.
- Watch another TV program.

To lock the VCR after setting the timer (Child Lock)

While the VCR turns on, hold POWER down on the VCR until “LOC” and the 🔒 indicator appear in the display window. The VCR turns off and the 🔒 indicator remains lit. The VCR will not work except for timer recording.

To unlock the VCR, hold POWER down on the VCR until the 🔒 indicator disappears from the display window. The VCR is unlocked and turns on.

To stop timer recording while the VCR is locked, press ■ STOP. The recording stops and the VCR is unlocked.

Tips

- To set the channel, you can also use the CH+/- or number buttons.
- To set the tape speed, you can also use the SP/EP button.

Playing/searching at various speeds

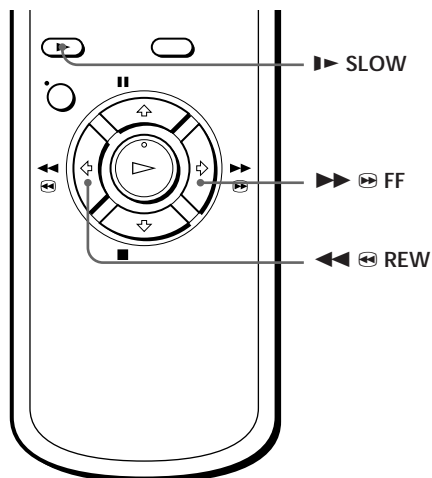
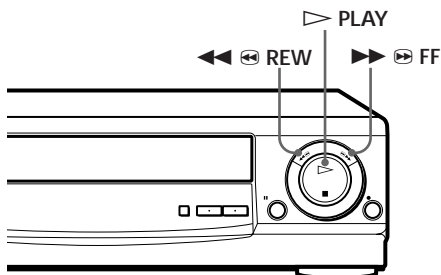

Playback options	Operation
View the picture during fast-forward or rewind	During fast-forward, hold ►►► FF down. During rewind, hold ◀◀◀ REW down.
Play at high speed	<ul style="list-style-type: none"> • During playback, press ►►► FF or ◀◀◀ REW. • During playback, hold ►►► FF or ◀◀◀ REW down. When you release the button, normal playback resumes.
Play in slow motion	During playback or pause, press ►► SLOW.
Play frame by frame	During pause, press ►►► FF or ◀◀◀ REW. Hold the button down to play one frame each second.
Rewind and start play	During stop, press ► PLAY <u>on the VCR</u> while holding ◀◀◀ REW down <u>on the VCR</u> .

To resume normal playback

Press ► PLAY.

Tip

- Adjust the picture using the TRACKING +/- buttons on the VCR if:
 - Streaks appear while playing in slow motion.
 - The picture shakes while pausing.
 To set tracking to the center position, press both buttons (+/-) at the same time.

Notes

- The sound is muted during these operations.
- Tapes recorded in the LP mode on other VCRs can be played back on this VCR but the picture quality cannot be guaranteed.
- The picture may have snow when playing at high speed in reverse.

Recording TV programs using the quick timer

After starting recording in the normal way, you can have the VCR stop recording automatically after a specified duration.

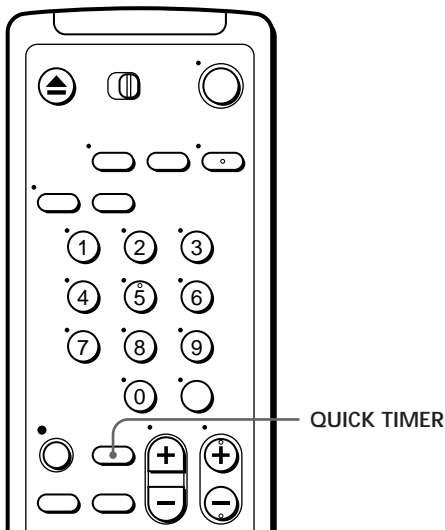

- 1 While recording, press QUICK TIMER once.

The ⌚ indicator appears in the display window.

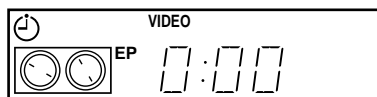

- 2 Press QUICK TIMER repeatedly to set the duration.

Each press advances the time in increments of 30 minutes.

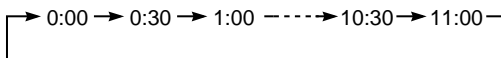

The duration decreases minute by minute to 0:00, then the VCR stops recording and turns off automatically.

To extend the duration

Press QUICK TIMER repeatedly to set to the new duration.

To stop the VCR while recording

Press ■ STOP.

Using the quick timer during stop mode

You can set the quick timer and start recording during stop mode by pressing QUICK TIMER. To set the channel, you can use the CH +/- or INPUT SELECT buttons. Press QUICK TIMER repeatedly to set the recording duration. The recording will start automatically.

Checking/ changing/ canceling timer settings

Before you start...

- Turn on your TV and set it to the video channel.

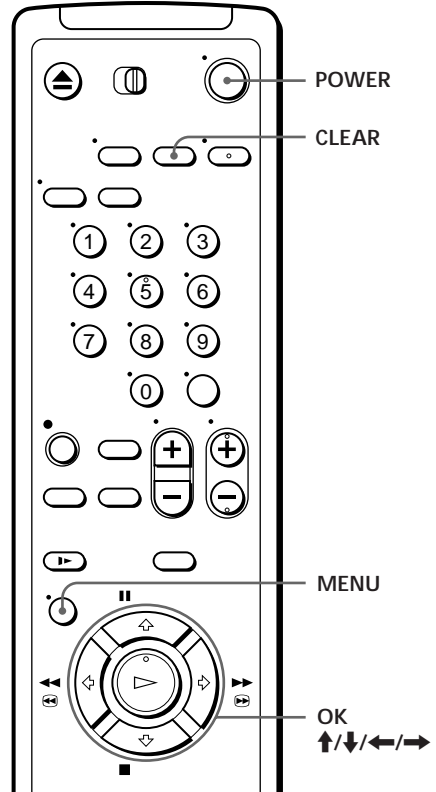

- 1 Press POWER to turn on the VCR.
- 2 Press MENU and select TIMER SET/CHECK:

- If you want to change a setting, go on to the next step.
- If you do not need to change the settings, press OK, then turn off the VCR to return to recording standby.

TIMER SET / CHECK	11 / 16	MO	
DATE	START	STOP	CH
▶ 11/17	TU 7:00AM	8:00AM	6SP
11/25	WE 10:30PM	11:15PM	50EP
MO - SA	1:00PM	3:00PM	LEP
EVERYSU	11:55AM	1:30PM	42SP
- / - -	- : - -	- : - -	- -
- / - -	- : - -	- : - -	- -
- / - -	- : - -	- : - -	- -
- / - -	- : - -	- : - -	- -

- 3 Press \uparrow/\downarrow to select the setting you want to change or cancel:
 - To change the setting, press \leftarrow/\rightarrow to flash the item you want to change, and press \uparrow/\downarrow to reset it. Then, press \rightarrow repeatedly until the cursor (▶) appears at the beginning of the line.
 - To cancel the setting, press CLEAR.
- 4 Press OK.

If any timer settings remain, turn off the VCR to return to recording standby.

When the timer settings overlap

The program that starts first has priority and the second program starts recording only after the first program has finished. If the programs start at the same time, the program listed first in the menu has priority.

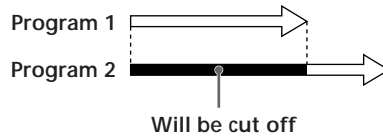

Adjusting the picture

Adjusting the tracking

Although the VCR automatically adjusts the tracking when playing a tape (the  indicator flashes in the display window, then goes off), distortion may occur if the tape was recorded in poor condition. In this case, manually adjust the tracking.

Press the TRACKING +/- buttons on the VCR to display the tracking meter. The distortion should disappear as you press one of the two buttons (the  indicator lights up). To resume automatic tracking adjustment, eject the tape and reinsert it.

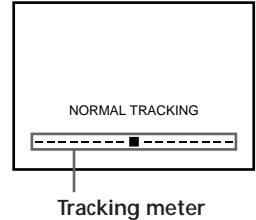

About Adaptive Picture Control (APC)

Adaptive Picture Control (APC) automatically improves recording and playback quality by adjusting the VCR to the condition of the video heads and tape. To maintain better picture quality, we recommend that you set APC to ON in the ADVANCED OPTIONS menu (with the APC indicator in the display window lit).

APC playback

The APC function automatically works on all types of tapes, including rental tapes and tapes that were not recorded with APC.

APC recording

Whenever you insert a tape and start recording at the first time, the VCR adjusts to the tape using the APC function (the APC indicator flashes rapidly). This adjustment is retained until the tape is ejected.

Notes

- The auto tracking adjustment cannot be guaranteed to work with tapes recorded in LP mode on other VCRs.
- With the Auto Tape Speed function on, the APC function doesn't work if the tape speed is automatically changed from the SP to EP mode during a timer recording, unless the tape has been recorded in the EP mode with the APC function. For details, see page 39.
- There is a delay of a few seconds before the VCR actually starts recording while the VCR analyzes the tape. To avoid the delay, first set the VCR to recording pause (the APC indicator flashes slowly) and press ● REC to have the VCR analyze the tape. After the APC indicator stops flashing, press ■ PAUSE to start recording immediately. If you press ■ PAUSE before the APC indicator stops flashing, the APC function is canceled.

Changing menu options

- 1 Press MENU and select **ADVANCED OPTIONS**.

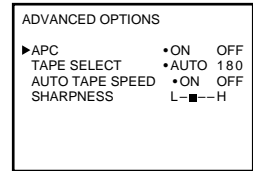

- 2 Press **↑/↓** to select the option to change, then press **←/→** to change the setting.
- 3 Press **OK** to return to the original screen.

Menu choices

Initial settings are indicated in bold print.

Menu option	Set this option to
APC	ON to switch on the APC (Adaptive Picture Control) function and improve picture quality. OFF to switch off APC.
TAPE SELECT	AUTO or 180 (when using a T-140 or T-180 tape) to operate AUTO TAPE SPEED correctly.
AUTO TAPE SPEED	ON to change the timer recording tape speed automatically to the EP mode when the remaining tape becomes shorter than the recording time. OFF to keep the set tape speed.
SHARPNESS	L (Low) through H (High) to adjust the sharpness of the picture. L to turn off the sharpness control.

Editing with another VCR

How to hook up to record on this VCR

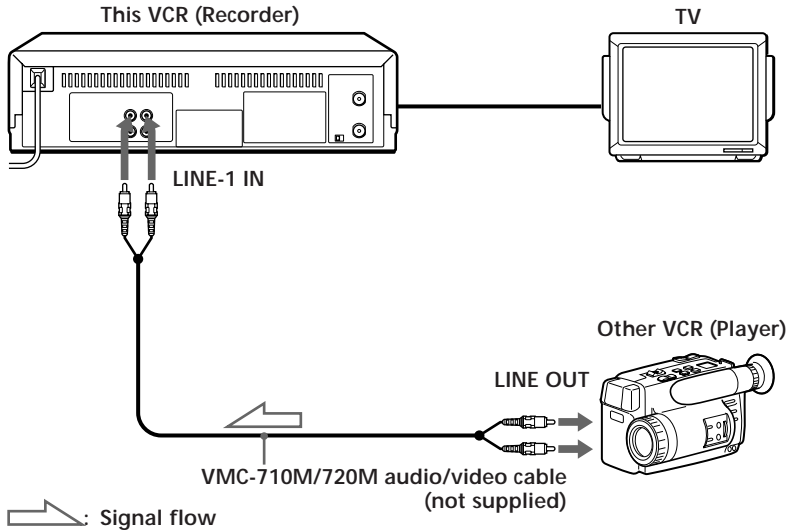

Notes

- Make sure you connect the plugs to jacks of the same color.
- If you connected this VCR to both the LINE IN and LINE OUT jacks of the other VCR, select the input correctly to prevent a humming noise.

Operation (when recording on this VCR)

Before you start editing

- Turn on your TV and set it to the video channel.
- Press INPUT SELECT on the remote commander to display “L” in the display window.
- Press SP/EP on the remote commander to select the tape speed, SP or EP.

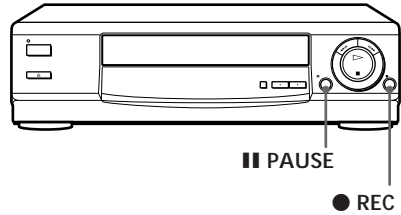

- 1 Insert a source tape with its safety tab removed into the other (playback) VCR. Search for the point to start playback and set it to playback pause.
- 2 Insert a tape with its safety tab in place into this (recording) VCR. Search for the point to start recording and press ■ PAUSE.
- 3 Press ● REC on this VCR and set it to recording pause.
- 4 To start editing, press the ■ PAUSE buttons on both VCRs at the same time.

To stop editing

Press the ■ STOP buttons on both VCRs.

Note

- If you start recording following the procedure above, the VCR won't start recording with the APC function. To record a tape with the APC function, press ● REC again during recording pause in step 3 so that the VCR analyzes the tape. Then when you start recording in step 4, press ■ PAUSE immediately after the APC indicator stops flashing. If you press ■ PAUSE before the APC indicator stops flashing, the APC function is canceled.

General setup information

Setting the RF unit

When connecting the VCR to the TV using only the antenna cable, you must set the RF UNIT switch on the rear of the VCR so that the TV can receive the correct signal from the VCR.

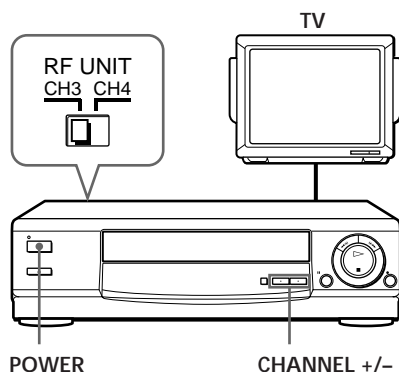

- 1 Set the RF UNIT switch on the rear of the VCR to CH 3 or CH 4, whichever channel is not used in your area. If both are used, set the switch to either channel.
- 2 Press POWER to turn on the VCR.
- 3 Press TV/VIDEO on the remote commander to turn on the VIDEO indicator in the VCR's display window.
- 4 Press CHANNEL +/- to display a channel number in the display window. Select an active channel number in your area.
- 5 Turn on your TV and set it to the channel you selected in step 1 (channel 3 or 4).

The selected TV channel broadcast appears on the TV screen. If the channels change when you press CHANNEL +/-, you have made the correct setting.

Whenever you use the VCR, set the TV to the channel selected in step 1.

Attaching the external antenna connector

When using a 300-ohm twin lead cable for a VHF/UHF antenna, use the EAC-32 antenna connector (not supplied) to connect the antenna to the VCR.

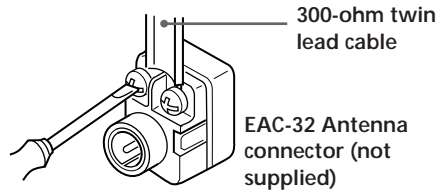

- 1 Loosen the screws on the antenna connector.
- 2 Wind the twin leads around the screws on the antenna connector.
- 3 Retighten the screws.

Attaching a UHF/VHF band mixer

When using both a 75-ohm coaxial cable and a 300-ohm twin lead cable for a VHF/UHF antenna, use the EAC-66 UHF/VHF band separator/mixer (not supplied) to connect the antenna to the VCR.

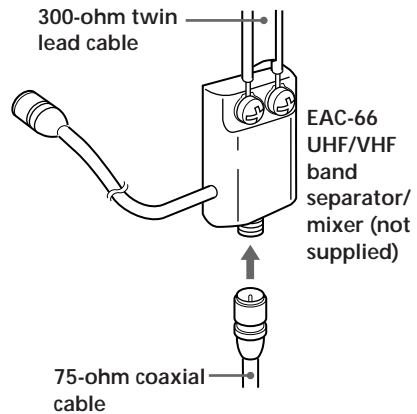

- 1 Loosen the screws on the mixer.
- 2 Wind the twin leads around the screws on the mixer.
- 3 Retighten the screws.
- 4 Connect the 75-ohm coaxial cable to the mixer.

Troubleshooting

If you have any questions or problems not covered below, please consult your nearest Sony dealer.

	Symptom	Remedy
Power	The POWER switch does not function.	<ul style="list-style-type: none"> • Connect the AC power cord securely. • Make sure the VCR is not locked. To unlock, hold POWER down on the VCR until the  indicator disappears.
	The power is turned on but the VCR does not operate.	<ul style="list-style-type: none"> • Moisture condensation occurs. Turn the power off, unplug the AC power cord and leave the VCR to dry for over an hour.
Clock	The clock has stopped and “-:-” lights in the display window.	<ul style="list-style-type: none"> • The clock stops if the VCR is disconnected from the wall outlet for more than one hour. Reset the clock (and timer).
	The playback picture does not appear on the TV screen.	<ul style="list-style-type: none"> • Make sure the TV is set to the channel for the VCR. If you are using a monitor, set it to video input.
Playback	The picture is not clear.	<ul style="list-style-type: none"> • Adjust the tracking with the TRACKING +/- buttons. • The video heads are dirty (see below). Clean the video heads using the Sony T-25CLD, T-25CLDR, or T-25CLW video head cleaning cassette. If these cleaning cassettes are not available in your area, have the heads cleaned at your nearest Sony service facility (a standard service charge will be required). Do not use a liquid-type cleaning cassette other than Sony's, as it may damage the video heads. • The video heads may have to be replaced. Consult your local Sony dealer for more information.
	The picture rolls vertically during picture search.	<ul style="list-style-type: none"> • Adjust the vertical hold control on the TV or monitor.
	The picture has no sound.	<ul style="list-style-type: none"> • The tape is defective. Use a new tape.

Symptoms caused by contaminated video heads

• Normal picture

• Rough picture

• Unclear picture

• No picture (or black & white screen appears)

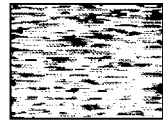
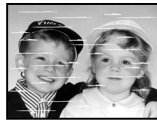

initial
contamination



terminal

	Symptom	Remedy
Recording	A TV program does not appear on the TV screen.	<ul style="list-style-type: none"> • Make sure the TV is set to the channel for the VCR. If you are using a monitor, set it to video input.
	TV reception is poor.	<ul style="list-style-type: none"> • Adjust the TV antenna.
	The tape starts playing as soon as it is inserted.	<ul style="list-style-type: none"> • The safety tab has been removed. To record on this tape, cover the tab hole.
	The tape ejects when you press ● REC.	<ul style="list-style-type: none"> • Check that the safety tab has not been removed.
Timer recording	Nothing happens when you press ● REC.	<ul style="list-style-type: none"> • Make sure the tape is not at its end. • Select the correct source. Select a channel number with the CH +/- buttons when recording TV programs; select "L" with the INPUT SELECT button when recording from other equipment.
	The timer does not operate.	<ul style="list-style-type: none"> • Check that the clock is set. • Make sure a tape has been inserted. • Check that the safety tab has not been removed. • Make sure the tape is not at its end. • Make sure a program has been set for timer recording. • Make sure your timer settings have not already passed the current time. • Check that the cable box is turned on. • The clock stops if the VCR is disconnected from the wall outlet for more than one hour. Reset the clock and timer.
Others	A tape cannot be inserted.	<ul style="list-style-type: none"> • Check that a tape isn't already in the tape compartment.
	The remote commander does not function.	<ul style="list-style-type: none"> • Make sure you are pointing the remote commander at the remote sensor on the VCR. • Replace all the batteries in the remote commander with new ones if they are weak. • Make sure the <input type="checkbox"/>TV<input type="checkbox"/>/VIDEO remote control switch is set correctly.
	The tracking meter does not appear on the screen.	<ul style="list-style-type: none"> • The recording condition of the tape is very poor and tracking cannot be adjusted.
	You cannot control other TVs.	<ul style="list-style-type: none"> • Set your TV's code number. The code number resets to 01 when you replace the batteries of the remote commander.
	The VCR needs to be cleaned.	<ul style="list-style-type: none"> • Clean the cabinet, panel and controls with a dry, soft cloth, or a soft cloth slightly moistened with a mild detergent solution. Do not use any type of solvent, such as alcohol or benzene.

Specifications

System

Format

VHS NTSC standard

Video recording system

Rotary head helical scanning FM system

Video heads

Double azimuth four heads

Video signal

NTSC color, EIA standards

Tape speed

SP: 33.35 mm/s ($1\frac{3}{8}$ inches/s)

EP: 11.11 mm/s ($\frac{7}{16}$ inches/s)

LP: 16.67 mm/s ($1\frac{1}{16}$ inches/s),
playback only

Maximum recording/playback time

8 hrs. in EP mode (with T-160 tape)

Fast-forward and rewind time

Approx. 3 min. (with T-120 tape)

Tuner section

Channel coverage

VHF 2 to 13

UHF 14 to 69

CATV A-8 to A-1, A to W, W+1 to W+84

Antenna

75-ohm antenna terminal for VHF/UHF

Inputs and outputs

LINE-1 IN

VIDEO IN, phono jack (1)

Input signal: 1 Vp-p, 75 ohms, unbalanced,
sync negative

AUDIO IN, phono jacks (1)

Input level: 327 mVrms

Input impedance: more than 47 kilohms

LINE OUT

VIDEO OUT, phono jack (1)

Output signal: 1 Vp-p, 75 ohms, unbalanced,
sync negative

AUDIO OUT, phono jacks (1)

Standard output: 327 mVrms

Load impedance: 47 kilohms

Output impedance: less than 10 kilohms

Timer section

Clock

Quartz locked

Timer indication

12-hour cycle

Timer setting

8 programs per month (max.)

Power back-up

Built-in self-charging capacitor

Back-up duration: up to 1 hour at a time

General

Power requirements

120 V AC, 60 Hz

Power consumption

23 W

Operating temperature

5°C to 40°C (41°F to 104°F)

Storage temperature

-20°C to 60°C (-4°F to 140°F)

Dimensions

Approx. 355 × 96 × 285 mm (w/h/d)

(Approx. 14 × 3 $\frac{3}{4}$ × 11 $\frac{1}{4}$ inches) including
projecting parts and controls

Mass

Approx. 3.7 kg (8 lb 3 oz)

Supplied accessories

Remote commander (1)

Size AA (R6) batteries (2)

75-ohm coaxial cable with F-type connectors (1)

Design and specifications are subject to change
without notice.

Index to parts and controls

Refer to the pages indicated in parentheses () for details.

Front panel

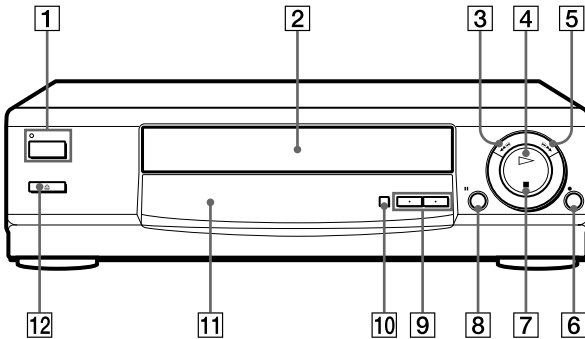

- | | |
|---|--|
| 1 POWER switch/indicator (32) | 7 ■ STOP button (27) |
| 2 Tape compartment | 8 PAUSE button (27) |
| 3 ◀◀ ⏮ REW (rewind) button (27, 34) | 9 CHANNEL/TRACKING +/- buttons (29, 38) |
| 4 ▷ PLAY button (27) | 10 EASY SET UP button (10, 12, 14, 16) |
| 5 ▶▶ ⏭ FF (fast-forward) button (27, 34) | 11 Remote sensor (5) |
| 6 ● REC (record) button (29) | 12 ▲ EJECT button (27) |

continued

Index to parts and controls (continued)

Display window

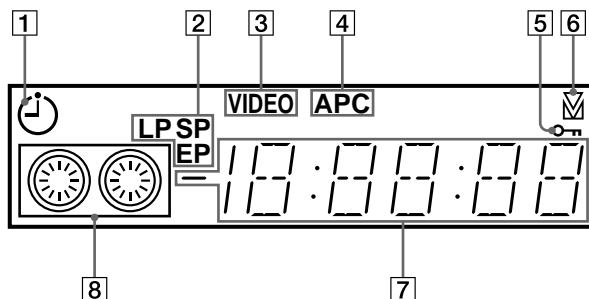

- | | | | |
|---|---|---|--|
| 1 | Timer indicator (32) | 5 | Child Lock indicator (33) |
| 2 | Tape speed indicator (29) | 6 | Tracking indicator (38) |
| 3 | VIDEO indicator (30, 42) | 7 | Time counter/clock/line/channel indicator (27, 29, 41) |
| 4 | APC (Adaptive Picture Control) indicator (38) | 8 | Tape/recording indicator (29) |

Rear panel

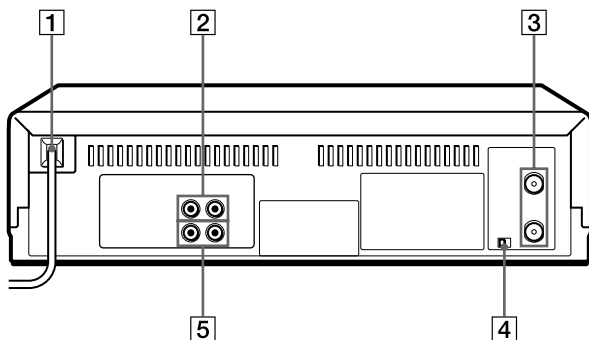

- | | | | |
|---|---|---|---------------------------------------|
| 1 | AC power cord (7) | 4 | RF (Radio Frequency) UNIT switch (42) |
| 2 | LINE-1 IN AUDIO/VIDEO jacks (40) | 5 | LINE OUT AUDIO/VIDEO jacks (8) |
| 3 | VHF/UHF IN/OUT connectors (9, 11, 13, 15) | | |

Remote commander

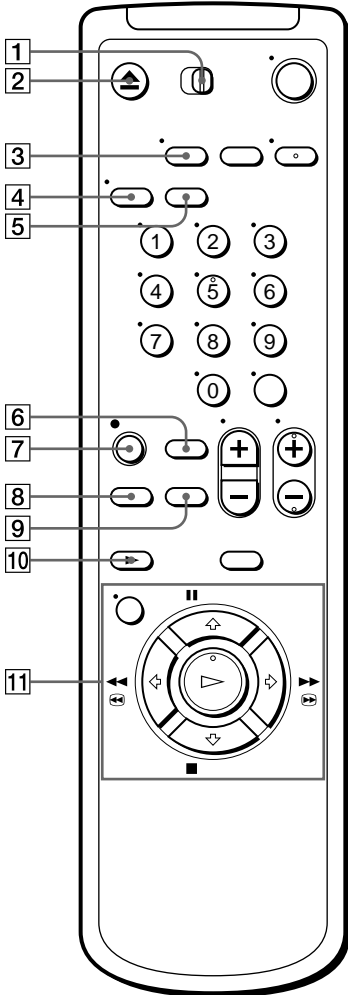

- 1 TV/VIDEO remote control switch (5)
- 2 ▲ EJECT button (27)
- 3 TV/VIDEO button (30, 42)
- 4 DISPLAY button (30)
- 5 COUNTER RESET button (27)
- 6 QUICK TIMER button (35)
- 7 ● REC (record) button (29)
- 8 SP (Standard Play)/EP (Extra Play) button (29)
- 9 INPUT SELECT button (29, 30)
- 10 ►► SLOW button (34)
- 11 Tape/menu operation buttons
 - MENU button (17, 39)
 - ⏸ PAUSE/▲ button (27)
 - STOP/▼ button (27)
 - ◀◀ ◀ REW (rewind)/◀ button (27, 34)
 - ▶▶ ▶ FF (fast-forward)/▶ button (27, 34)
 - ▷ PLAY/OK button (27)

continued

Index to parts and controls (continued)

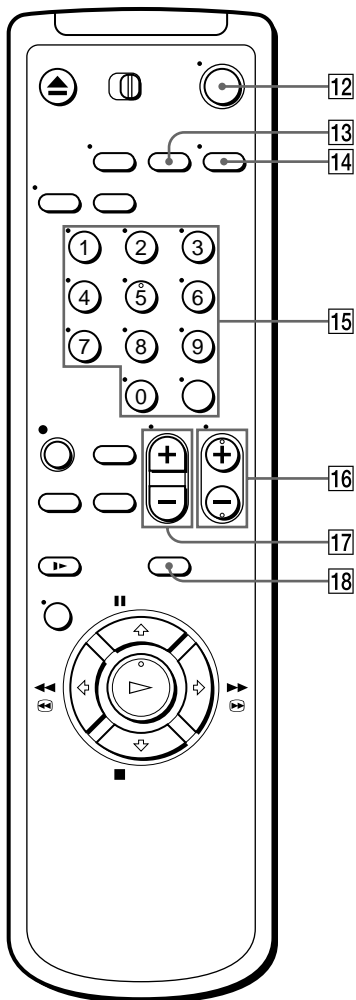

- 12 POWER switch (32)
- 13 CLEAR button (36)
- 14 AUDIO MONITOR button
(This button doesn't work for this VCR.)
- 15 Number buttons and ENTER button (23)
- 16 CH (channel) +/- buttons (29)
- 17 VOL (volume) +/- buttons (6)
- 18 SMART CUE button (27)

Index

A, B

- AFT (Auto Fine Tuning) 24
- Antenna hookup 9
- APC (Adaptive Picture Control) 38
- Audio/video (A/V) hookup 8

C

- Cable hookup 11, 13, 15
- Canceling timer settings 36
- Changing timer settings 36
- Checking timer settings 36
- Child Lock 33
- Cleaning the video heads 44
- Clock setting 18
- Connecting
 - cable TV 11, 13, 15
 - external antenna connector 43
 - UHF/VHF band mixer 43
- Counter 27

D

- Disabling channels 22
- Dubbing. *See* Editing.

E, F, G, H, I, J, K

- Easy Set Up 10, 12, 14, 16
- Editing 40
- EP mode 29

L, M, N, O

- Language selecting 17
- Locking the VCR 33
- LP mode 27

P

- Picture adjustment 24, 34, 38
- Playback 26
 - at various speeds 34
 - frame-by-frame 34
 - skip 27
 - slow motion 34
- Presetting channels 20

Q

- Quick timer 35

R

- Recording 28
 - saving 30
 - while watching another program 30

S

- Safety tab 30
- Searching at various speeds 34
- SP mode 29

T, U, V, W, X, Y, Z

- Timer recording 31
 - canceling timer settings 36
 - changing timer settings 36
 - checking timer settings 36
 - daily/weekly recording 32
 - overlapping timer recordings 37
- Tracking adjustment 34, 38

Quick reference to using the VCR

Hookup 1

To play a tape

- 1 Set the TV to channel 3 or 4 (or to video input, if you made A/V connections.)
- 2 Insert a tape and press PLAY. If there's no picture on your TV, press the VCR's TV/VIDEO button until the VIDEO indicator comes on in the display window.

To record a program

- 1 Press MENU and select TIMER SET/CHECK.
- 2 Set the date, time, channel, and tape speed.
- 3 Press OK.
- 4 Insert a tape.
- 5 Press POWER to turn off the VCR.

To watch TV

- 1 Turn off the VCR, or press the VCR's TV/VIDEO button until the VIDEO indicator in the display window goes off.
- 2 Set the TV to the channel you want to watch.

Hookup 2

To play a tape

- 1 Set the TV to channel 3 or 4 (or to video input, if you made A/V connections.)
- 2 Insert a tape and press PLAY. If there's no picture on your TV, press the VCR's TV/VIDEO button until the VIDEO indicator comes on in the display window.

To record a program

- 1 Turn on the cable box.
- 2 Set the cable box to the channel you want to record.
- 3 Press MENU and select TIMER SET/CHECK.
- 4 Set the date, time, channel, and tape speed.
- 5 Press OK.
- 6 Insert a tape.
- 7 Press POWER to turn off the VCR.
Leave the cable box on.

To watch TV

- 1 Turn off your VCR, or press the VCR's TV/VIDEO button until the VIDEO indicator in the display window goes off.
- 2 Turn on your cable box.
- 3 Set the TV to the cable box output channel (usually 2, 3, or 4).
- 4 Set the cable box to the channel you want to watch.

Hookup 3

To play a tape

- 1 If you made A/V connections, set the TV to video input. If you didn't use A/V hookup:
 - Turn on the cable box.
 - Set the cable box to channel 3 or 4.
 - Set the TV to the output channel of the cable box (usually 2, 3 or 4).
- 2 Insert a tape and press PLAY.

To record a program

- 1 Press MENU and select TIMER SET/CHECK.
- 2 Set the date, time, channel, and tape speed.
- 3 Press OK.
- 4 Insert a tape.
- 5 Press POWER to turn off the VCR.

To watch TV

- 1 Turn off your VCR, or press the VCR's TV/VIDEO button until the VIDEO indicator in the display window goes off.
- 2 Select the channel with your cable box (if you have one) or with your TV.

If you have any questions about this product, you may call: **Sony Customer Information Center** 1-800-222-SONY (7669) or write to: **Sony Customer Information Center** Sony Drive, Mail Drop #T1-11, Park Ridge, NJ 07656