

Video Cassette Recorder

Operating Instructions



Hi-Fi

G-CODE

SLV-X847ML

WARNING

To prevent fire or shock hazard, do not expose the unit to rain or moisture.

To avoid electrical shock, do not open the cabinet. Refer servicing to qualified personnel only.

The mains lead must only be changed at a qualified service shop.

Precautions

Safety

- This unit operates on 110 – 240 V AC, 50/60 Hz. Check that the unit's operating voltage is identical with your local power supply.
- If anything falls into the cabinet, unplug the unit and have it checked by qualified personnel before operating it any further.
- The unit is not disconnected from the mains as long as it is connected to the mains, even if the unit itself has been turned off.
- Unplug the unit from the mains if you do not intend to use it for an extended period of time. To disconnect the lead, pull it out by the plug, never by the lead.

Installing

- Allow adequate air circulation to prevent internal heat buildup.
- Do not place the unit on surfaces (rugs, blankets, etc.) or near materials (curtains, draperies) that may block the ventilation slots.
- Do not install the unit near heat sources such as radiators or air ducts, or in a place subject to direct sunlight, excessive dust, mechanical vibration or shock.
- Do not install the unit in an inclined position. It is designed to be operated in a horizontal position only.
- Keep the unit and cassettes away from equipment with strong magnets, such as microwave ovens or large loudspeakers.
- Do not place heavy objects on the unit.
- If the unit is brought directly from a cold to a warm location, moisture may condense inside the VCR and cause damage to the video head and tape. When you first install the unit, or when you move it from a cold to a warm location, wait for about one hour before operating the unit.

Caution

Television programmes, films, video tapes and other materials may be copyrighted. Unauthorized recording of such material may be contrary to the provisions of the copyright laws. Also, use of this recorder with cable television transmission may require authorization from the cable television transmitter and/or programme owner.

Compatible colour systems

This VCR is designed to record and play back using the PAL (B/G, D/K, and I), MESECAM (B/G, D/K, and K1), or NTSC (M) color systems. Recording of video sources based on other color systems cannot be guaranteed.

Table of contents

Getting Started

- 4 Step 1: Unpacking
- 5 Step 2: Setting up the remote commander
- 8 Step 3: Connecting the VCR
- 11 Step 4: Tuning your TV to the VCR
- 14 Step 5: Setting up the VCR with EASY SET UP
- 17 Manual setup —
 - Selecting a language, Presetting channels, Setting up G-CODE*, Changing/disabling programme positions, Setting the clock

Basic Operations

- 40 Playing a tape
- 44 Recording TV programmes
- 47 Recording TV programmes using G-CODE
- 50 Setting the timer manually

Additional Operations

- 53 Playing/searching at various speeds
- 55 Recording TV programmes using the quick timer
- 56 Checking/changing/cancelling timer settings
- 57 Recording stereo and bilingual programmes
- 60 Searching with the index function
- 61 Adjusting the picture
- 62 Changing menu options

Editing

- 63 Connecting to a VCR or stereo system
- 64 Basic editing

Additional Information

- 65 Troubleshooting
- 68 Specifications
- 69 Index to parts and controls
- Back cover
 - Index

* G-CODE is a trademark of Gemstar Development Corporation. The G-CODE system is manufactured under license from Gemstar Development Corporation.

Step 1

Unpacking

Check that you have received the following items with the VCR:

- Remote commander

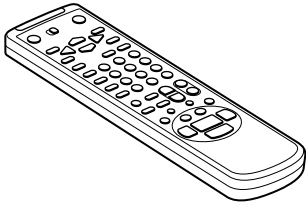

- Aerial cable

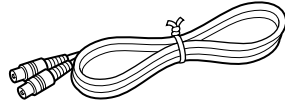

- Audio/video cable (3-phono to 3-phono)

- R6 (size AA) batteries

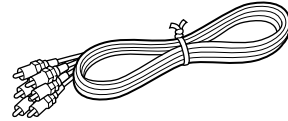
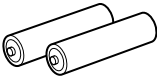

Step 2

Setting up the remote commander

Inserting the batteries

Insert two R6 (size AA) batteries by matching the + and - on the batteries to the diagram inside the battery compartment.

Insert the negative (-) end first, then push in and down until the positive (+) end clicks into position.

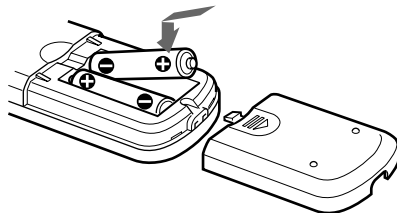

Using the remote commander

You can use this remote commander to operate this VCR and a Sony TV. Buttons on the remote commander marked with a dot (•) can be used to operate your Sony TV.

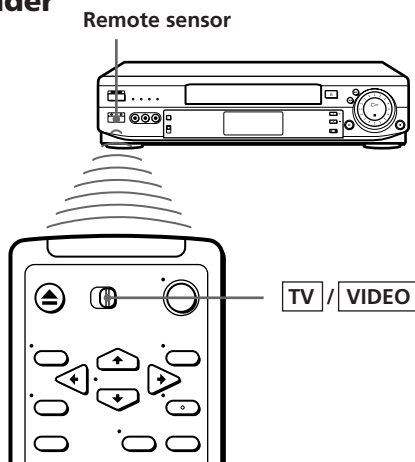

To operate	Set TV / VIDEO to
the VCR	VIDEO and point at the remote sensor on the VCR
a Sony TV	TV and point at the remote sensor on the TV

continued

Step 2 : Setting up the remote commander (continued)

Notes

- The TV/VIDEO button selects an input source of the TV from aerial in or line in. The button does not control this VCR.
- With normal use, the batteries should last about three to six months.
- If you do not use the remote commander for an extended period of time, remove the batteries to avoid possible damage from battery leakage.
- Do not use a new battery with an old one.
- Do not mix different types of batteries.

Controlling other TVs with the remote commander

The remote commander is preprogrammed to control non-Sony TVs. If your TV is listed in the table below, set the appropriate manufacturer's code number.

- 1 Set **TV** / **VIDEO** at the top of the remote commander to **TV**.
- 2 Hold down **⏻**, and enter your TV's code number(s) using the programme number buttons. Then release **⏻**.
Now you can use the following TV control buttons to control your TV:
⏻ (on/standby), **TV/VIDEO**, programme number buttons, **PROG +/-**, **VOL +/-**, and **WIDE** with some TV.

Tip

- If you set your TV's code number correctly while the TV is turned on, the TV turns off automatically.

Code numbers of controllable TVs

If more than one code number is listed, try entering them one at a time until you find the one that works with your TV.

To make wide mode settings, see the footnotes below this table for the applicable code numbers.

Manufacturer	Code number	Manufacturer	Code number
Sony	01* ¹ , 02, 03, 04, 05	NEC	66
Aiwa	32	Nokia	15, 16, 69* ³
Akai	68	Nordmende	35, 42
Blaupunkt	10, 21	Orion	47, 48
Brionvega	40	Panasonic	17* ¹ , 49
C.G.M	09	Philips	06* ¹ , 07* ¹ , 08* ¹
Colonad	03	Phonola	18, 19
Dual	44	Pioneer	26
Emerson	03, 04	Saba	12, 13
Fenner	30, 31	Samsung	22, 23
Ferguson	52	Sanyo	25
Gold Star	03, 04, 17	Schneider	46
Grundig	10* ¹ , 11* ¹	Seleco	14
Hitachi	24	Sharp	29
Hyper	31	Siemens	39
Inno-Hit	41	Sinudyne	37
Irradio	20	TEAC	67
ITT	15, 16, 69* ³	Telefunken	36
JVC	33* ¹	Thomson	43* ²
Loewe	45	Toshiba	38
Mitsubishi	27* ¹ , 28* ¹ , 50* ¹ , 51* ¹	White Westinghouse	34
Mivar	09		

*¹ Press WIDE to switch the wide picture mode on or off.

*² Press WIDE, then press VOL +/- to select the wide picture mode you want.

*³ Press WIDE. The menu appears on the TV screen. Then, press CURSOR $\uparrow/\downarrow/\leftarrow/\rightarrow$ to select the wide picture you want and press EXECUTE.

Notes

- If the TV uses a different remote control system from the one programmed to work with the VCR, you cannot control your TV with the remote commander.
- If you enter a new code number, the code number previously entered will be erased.
- When you replace the batteries of the remote commander, the code number automatically resets to 01 (Sony). Reset the appropriate code number.

Step 3

Connecting the VCR

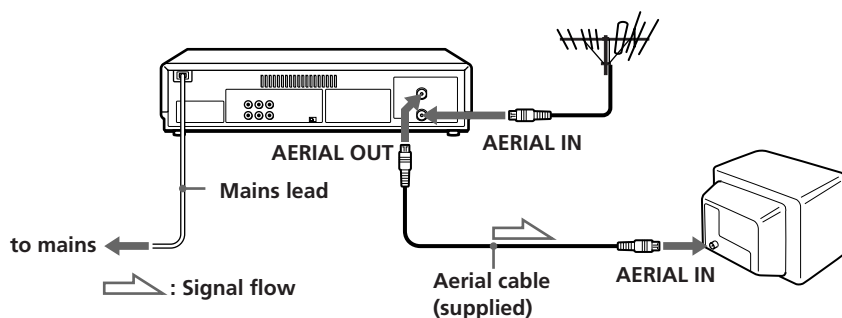

1

Disconnect the aerial cable from your TV and connect it to AERIAL IN on the rear panel of the VCR.

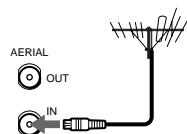

2

Connect AERIAL OUT of the VCR and the aerial input of your TV using the supplied aerial cable.

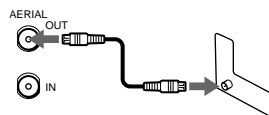

3

Connect the mains lead to the mains.

Additional connections

To a TV that has phono type audio/video input jacks

This additional connection improves picture and sound quality. Connect the TV as shown on the right.

If you want to use the Trinitron TV Synchro Play function (see page 43), this connection is necessary. (If your TV has two or more inputs, connect the audio/video cable to the VIDEO IN 1 jacks.)

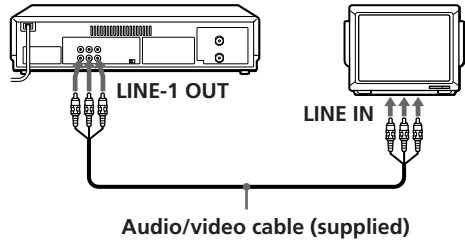

To a stereo system

You can improve sound quality by connecting a stereo system as shown on the right.

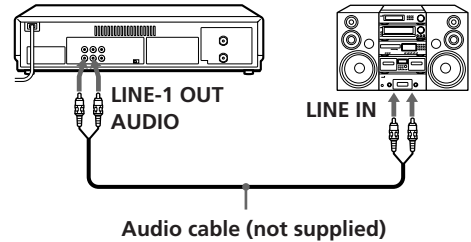

About color systems

Different countries use different color systems and TV systems. These systems handle such things as video playback and recording differently. Using your VCR in a country that is on a color system not supported by this VCR may cause problems such as playback without sound, a vertically rolling picture, etc.

This VCR is compatible with most of the existing color systems (NTSC, PAL, and MESECAM) and TV systems (B/G, D/K, I, and M) except for those used in France, Brazil, Argentina, and Uruguay.

continued

Step 3 : Connecting the VCR (continued)

Setting the NTSC PB switch to match your TV system

You have to set the NTSC PB switch on the rear of the VCR according to your TV system to display the on-screen menus when there is no video signal input, and play back a tape recorded in the NTSC 3.58 system properly.

Set the NTSC PB switch following the table below.

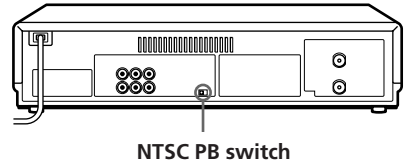

If your TV is compatible with	Set the NTSC PB switch to
PAL, SECAM, or MESECAM	ON PAL TV
NTSC 4.43	NTSC 4.43
NTSC 3.58	NTSC 3.58

Notes

- If a video signal is input to the VCR (via the line input, tuner, or playback), the on-screen menus will appear on your TV regardless of the NTSC PB switch setting.
- If your TV is compatible with the SECAM system, the on-screen menus may be displayed in black and white.

Step 4

Tuning your TV to the VCR

If you have connected your VCR to the TV using the audio/video cable, skip this step.

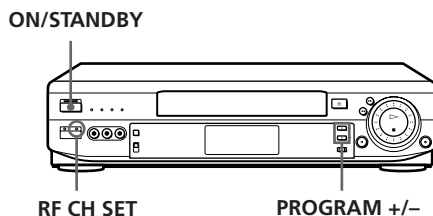

- 1**  Press ON/STANDBY to turn on the VCR.

- 2**  Press RF CH SET on the VCR with a ball-point pen, etc.
The factory-preset RF channel appears in the display window.
The VCR signal is output through this channel to the TV.

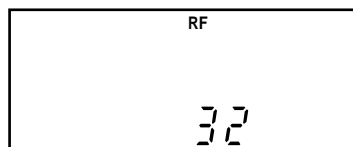

- 3** Turn on your TV and select a programme position for the VCR picture.
This channel will now be referred to as the video channel.

continued

Step 4 : Tuning your TV to the VCR (continued)

4

RF CH
SET
○

Press RF CH SET.

The TV system indicator appears in the display window.

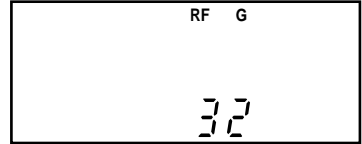

PROGRAM
+
-
○

Press PROGRAM +/- to select the desired TV system.

If your TV color system and TV system are		Select
PAL	I	I
	D/K	K
	B/G	G
NTSC	M	M

5

Tune the TV to the same channel as that shown in the display window so that the picture on the right appears on the TV screen.

Refer to your TV manual for tuning instructions.

If the picture does not appear clearly, see "To obtain a clear picture from the VCR" below.

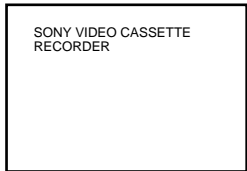

SONY VIDEO CASSETTE
RECORDER

6

RF CH
SET
○

Press RF CH SET.

You have now tuned your TV to the VCR. From now on, whenever you want to play a tape, set the TV to the video channel.

To check to see if the TV tuning is correct

Set the TV to the video channel and press PROGRAM +/- on the VCR. If the TV screen changes to a different programme each time you press PROGRAM +/-, the TV tuning is correct.

To obtain a clear picture from the VCR

If the picture does not appear clearly in step 5 above, go to step 6 to finish this procedure once. Then start again from step 2. After pressing RF CH SET in step 2, press PROGRAM +/- while the RF channel is displayed, so that another RF channel (between 28 and 55) appears (see page 24 for reference). Then tune the TV to the new RF channel until a clear picture appears.

Note

- If you set the wrong TV system, you may have no sound or sound may be distorted (noisy sound).

Step 5

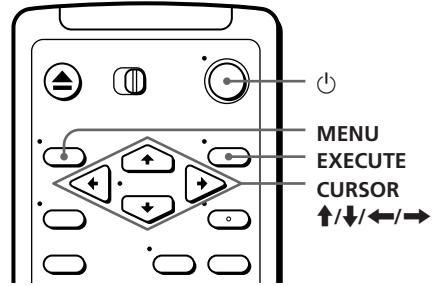

Setting up the VCR with EASY SET UP

Before using the VCR for the first time, set up the VCR using the EASY SET UP function. With this function, you can set the language for the on-screen display, TV channels, guide channels for G-CODE, and the VCR clock, guided by the sequence indicated on the TV screen.

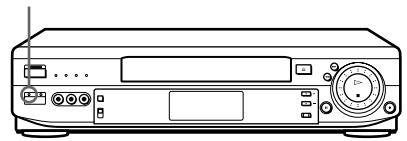

EASY SET UP





1  Press  to turn on the VCR.

2 Turn on your TV and set it to the video channel.

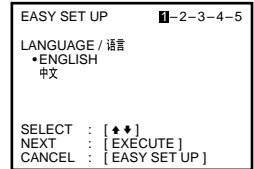
3  Press EASY SET UP on the VCR with a ball-point pen, etc.
To cancel the EASY SET UP function, press EASY SET UP again.

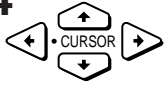

4  Press CURSOR / to select the desired language, then press EXECUTE.
The TV SYSTEM menu appears.

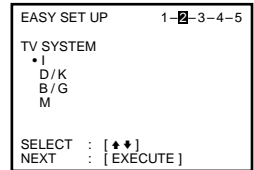

5

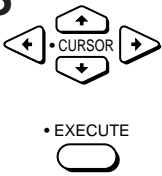

Press CURSOR \uparrow/\downarrow to select either I, D/K, B/G, or M, whichever is applicable in your area, then press EXECUTE.

The VCR starts searching for all the receivable channels.

During presetting, the channel being located is displayed on the screen.

When all the channels are preset, the following screen appears.

Even if various TV systems coexist in your area, the AUTO TUNER PRESET function picks up most of the channels on the TV systems other than the one you selected. But you need to manually reset the proper TV system for the unmatched channels (see "Resetting the TV system" on page 22).

If necessary, you can add or disable the channels manually (see "Presetting channels manually" on page 20).

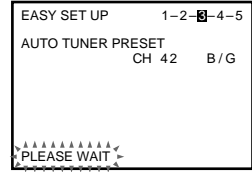

EASY SET UP		1-2-3-4-5	
PROG	CH	GUIDE	CH
1	3	-	---
2	9	-	---
3	12	-	---
4	27	-	---
5	56	-	---

SELECT : [♦♦]
 MOVE PROG : [♦]
 ERASE PROG : [TIMER CLEAR]

6

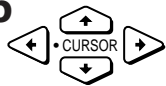

Using CURSOR $\uparrow/\downarrow/\leftarrow/\rightarrow$, set the G-CODE guide channels, change the programme positions of the stations, and disable the unused programme positions. (If not necessary, skip this step.)

The setting procedures are the same as those described in "Manual setup — Setting up G-CODE" on page 32 and "Manual setup — Changing/disabling programme positions" on page 35.

7



Press EXECUTE.

The CLOCK SET menu appears.

8

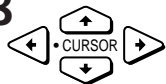

Set the date and time using CURSOR $\uparrow/\downarrow/\leftarrow/\rightarrow$. The setting procedures are the same as those described in "Manual setup—Setting the clock" on page 38.

EASY SET UP		1-2-3-4-5	
CLOCK SET			
25. 10. 1997 SAT 15:30			
SELECT	:	[♦♦]	
SET	:	[♦♦]	
END	:	[EXECUTE]	

9



Press EXECUTE.

continued

Step 5 : Setting up the VCR with EASY SET UP (continued)

Notes

- Do not exit EASY SET UP while the VCR is presetting channels. If you do, repeat EASY SET UP from the beginning.
- The channel numbers preset using AUTO TUNER PRESET may not match your local channel numbers. This is because this VCR's channel search system is based on the fixed TV system with the widest channel coverage.
In this case, you can apply your local channel numbers to the programme positions (see "Changing programme positions" on page 35).
- If the received channel is on cable TV, "C" appears on the left of the channel in step 5 in most areas. However, this won't be applied in some areas (see pages 24 to 31 for reference).

Manual setup — Selecting a language

You can change the on-screen display language from the one you selected with the EASY SET UP function.

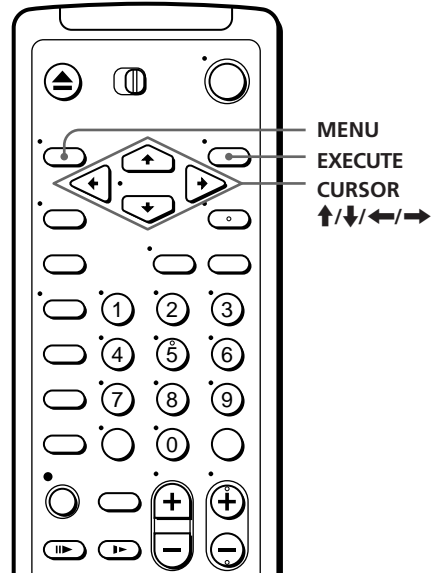

Before you start...

- Turn on the VCR and the TV.
- Set the TV to the video channel.

1

• MENU



Press MENU, then press CURSOR \uparrow/\downarrow to move the cursor (\blacktriangleright) to LANGUAGE and press EXECUTE.

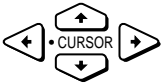

• EXECUTE



LANGUAGE / 语言

• ENGLISH
中文

SELECT : [\blacktriangle \blacktriangleright \blacktriangleleft]
END : [EXECUTE]

2

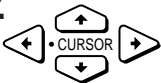

Press CURSOR \uparrow/\downarrow to select the desired language, then press EXECUTE.

• EXECUTE



LANGUAGE / 语言

ENGLISH
• 中文

选择 : [\blacktriangle \blacktriangleright \blacktriangleleft]
完毕 : [EXECUTE]

Manual setup — Presetting channels

First, we recommend that you preset the receivable channels in your area using EASY SET UP or using automatic presetting below. Then, if some channels could not be preset automatically, you can preset them manually; if there are any unwanted channels among the preset ones, you can disable the channels.

If you live in the area where various TV systems coexist, and have channels that don't match the TV system you selected in AUTO TUNER PRESET in the EASY SET UP procedure, reset the TV system for those channels (see "Resetting the TV system" on page 22). If the channels don't match the TV system, the sound may be distorted or noisy, or the color TV program may become black and white, etc. Even if you choose CATV, normal channels may be tuned in, and vice versa depending on the area (see pages 24 to 31 for reference).

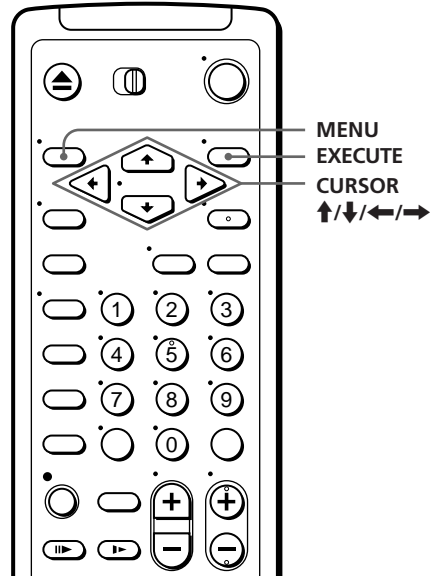

Before you start...

- Turn on the VCR and the TV.
- Set the TV to the video channel.

Presetting all receivable channels automatically

If you have preset the channels using the EASY SET UP procedure, skip this procedure.

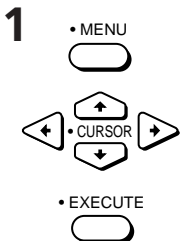

Press MENU, then press CURSOR \uparrow/\downarrow to move the cursor (▶) to TUNER PRESET and press EXECUTE.

TUNER PRESET	PROG1
SYSTEM • I D/K B/G M	• NORM CATV
NORMAL / CATV	• NORM CATV
AUTO PRESET	
▶ CHANNEL SET	2
AFT	• ON OFF
FINE TUNING	
SELECT : [\blacktriangle \blacktriangledown]	
SET : [\blacktriangle \blacktriangledown]	

2

Press CURSOR $\uparrow/\downarrow/\leftarrow/\rightarrow$ to move the cursor (\blacktriangleright) to SYSTEM, then select either I, D/K, B/G, or M, whichever is applicable in your area. If SYSTEM is set to the wrong position, the sound will be distorted or noisy.

TUNER PRESET	PROG1
\blacktriangleright SYSTEM \bullet I	D/K B/G M
NORMAL / CATV	\bullet NORM CATV
AUTO PRESET	
CHANNEL SET	2
AFT	\bullet ON OFF
FINE TUNING	
SELECT :	[\blacklozenge]
SET :	[\blacklozenge]

3

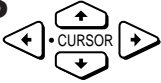

Press CURSOR $\uparrow/\downarrow/\leftarrow/\rightarrow$ to move the cursor (\blacktriangleright) to NORMAL/CATV, then select NORM.

To preset CATV channels, select CATV.

TUNER PRESET	PROG1
SYSTEM \bullet I	D/K B/G M
\blacktriangleright NORMAL / CATV	\bullet NORM CATV
AUTO PRESET	
CHANNEL SET	2
AFT	\bullet ON OFF
FINE TUNING	
SELECT :	[\blacklozenge]
SET :	[\blacklozenge]

4

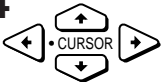

• EXECUTE



Press CURSOR \uparrow/\downarrow to move the cursor (\blacktriangleright) to AUTO PRESET, then press EXECUTE.

All receivable channels are preset in numerical sequence. When no more receivable channels can be found, presetting stops and the picture from the lowest numbered channel is displayed on the TV screen.

TUNER PRESET	PROG1
SYSTEM \bullet I	D/K B/G M
NORMAL / CATV	\bullet NORM CATV
\blacktriangleright AUTO PRESET	
CHANNEL SET	2
AFT	\bullet ON OFF
FINE TUNING	
▲▲▲▲▲▲▲▲▲▲ ▲PLEASE WAIT▲ ▼▼▼▼▼▼▼▼▼▼	

Notes

- If you connect the VCR to a TV with the NTSC colour system, the picture quality may be compromised during automatic presetting. A colour picture appears when presetting is complete.
- The channel numbers besides CHANNEL SET may not be the same as those in your area. This is because this VCR's channel search system is based on the fixed TV system that has the widest channel coverage. If necessary, apply your local channel numbers to the programme positions (see "Changing programme positions" on page 35).

continued

Manual setup — Presetting channels (continued)

Presetting channels manually

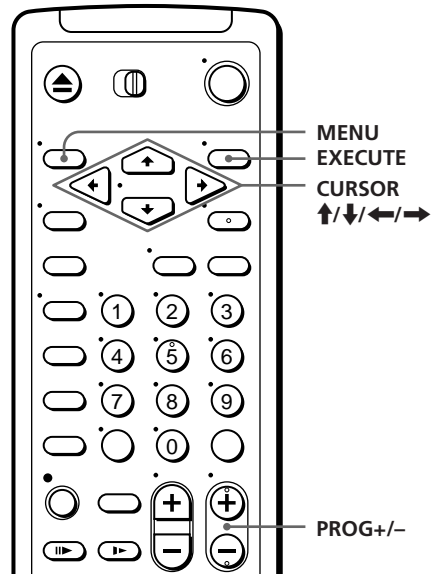

1

•MENU

•EXECUTE

•CURSOR

Press MENU, then press CURSOR ↑/↓ to move the cursor (▶) to TUNER PRESET and press EXECUTE.

TUNER PRESET	PROG10
SYSTEM	•I D/K B/G M
NORMAL / CATV	•NORM CATV
AUTO PRESET	
▶CHANNEL SET	3
AFT	•ON OFF
FINE TUNING	
SELECT	: [♦♦]
SET	: [♦♦]

2

•CURSOR

Press CURSOR ↑/↓/←/→ to move the cursor (▶) to NORMAL / CATV, then select NORM.

To preset CATV channels, select CATV.

TUNER PRESET	PROG10
SYSTEM	•I D/K B/G M
▶NORMAL / CATV	•NORM CATV
AUTO PRESET	
CHANNEL SET	3
AFT	•ON OFF
FINE TUNING	
SELECT	: [♦♦]
SET	: [♦♦]

3

•CURSOR

Press CURSOR ↑/↓ to move the cursor (▶) to CHANNEL SET.

TUNER PRESET	PROG10
SYSTEM	•I D/K B/G M
NORMAL / CATV	•NORM CATV
AUTO PRESET	
▶CHANNEL SET	3
AFT	•ON OFF
FINE TUNING	
SELECT	: [♦♦]
SET	: [♦♦]

4

•PROG



Press PROG +/- to select the programme position.

Selected programme position

TUNER PRESET	PROG14
SYSTEM	• I D/K B/G M
NORMAL / CATV	• NORM CATV
AUTO PRESET	
▶ CHANNEL SET	3
AFT	• ON OFF
FINE TUNING	
SELECT :	[♦♦]
SET :	[♦♦]

5

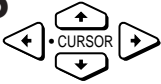

Press CURSOR → repeatedly until the channel you want is displayed. Pressing CURSOR ← goes back to the previous channels.

The channels are scanned in the order shown on pages 24 to 31.

If you know the number of the channel you want, press the programme number buttons. For example, for channel 5, first press "0" and then press "5."

TUNER PRESET	PROG14
SYSTEM	• I D/K B/G M
NORMAL / CATV	• NORM CATV
AUTO PRESET	
▶ CHANNEL SET	4
AFT	• ON OFF
FINE TUNING	
SELECT :	[♦♦]
SET :	[♦♦]

6

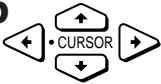

If the TV sound is distorted or noisy, press CURSOR ↑/↓/←/→ to move the cursor (▶) to SYSTEM, then select either I, D/K, B/G, or M, whichever is applicable in your area.

TUNER PRESET	PROG14
▶ SYSTEM	• I D/K B/G M
NORMAL / CATV	• NORM CATV
AUTO PRESET	
CHANNEL SET	4
AFT	• ON OFF
FINE TUNING	
SELECT :	[♦♦]
SET :	[♦♦]

7

•EXECUTE



To allocate another channel to another programme position, repeat steps 4 and 5.

8

Press EXECUTE.

Note

- The channel numbers besides CHANNEL SET may not be the same as those in your area. This is because this VCR's channel search system is based on the fixed TV system that has the widest channel coverage. If necessary, apply your local channel numbers to the programme positions (see "Changing programme positions" on page 35).

continued

Manual setup — Presetting channels (continued)

Disabling unwanted programme positions

After tuning the TV channels, you can disable unused programme positions. The disabled positions will be skipped later when you press the PROG +/- buttons.

You can also disable unwanted programme positions using the SET UP CH AND G-CODE menu (see page 32).

- 1 In step 5 above, press programme number button “0” twice to display the number “0” beside CHANNEL SET.
- 2 Press EXECUTE.

Resetting the TV system (only for areas where various TV systems coexist)

If the sound is distorted or noisy, or the color TV programme becomes black and white, etc., that channel may not be matched to the proper TV system. In this case, try the following steps.

- 1 Press PROG +/- to select the programme position that has the channel with above described conditions.
- 2 Press MENU, then select TUNER PRESET and press EXECUTE.
- 3 Select SYSTEM and select the TV system on which you can obtain the best sound and picture.
- 4 Repeat steps 2 and 3 for other positions you want to preset the TV system to.
- 5 Press EXECUTE.

Checking the TV system

Press PROG +/- to choose the programme position.

The multi system indicator (I, D/K, B/G, or M) of the selected programme position’s TV system lights up.

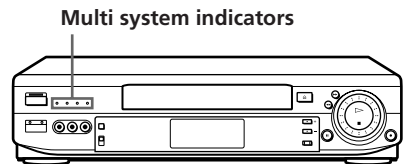

If the picture is not clear

Normally, the Auto Fine Tuning (AFT) function automatically tunes in channels clearly. If, however, the picture is not clear, you may also use the manual tuning function.

- 1 Press PROG +/- to select the programme number for which you cannot obtain a clear picture.
- 2 Press MENU, then select TUNER PRESET and press EXECUTE.
- 3 Select FINE TUNING. The fine tuning meter appears.

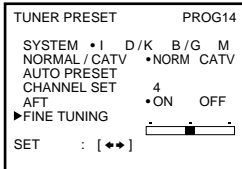

- 4 Press CURSOR ←/→ to get a clearer picture, then press EXECUTE.
Note that the AFT (Auto Fine Tuning) setting switches to OFF.

Note

- The menu disappears automatically if you don't proceed for more than a few minutes.

continued

Manual setup — Presetting channels (continued)

Channel numbers in the CHANNEL SET field and the corresponding channels

TV system	B/G				
Country	Western Europe	Australia	New Zealand	Morocco	Indonesia
Channel number in the CHANNEL SET field	Corresponding channels				
1		A50	1		1A
2	E2				
3	E3	1	2		2A
4	E4	2	3		3A
5	E5	6	4		4A
6	E6	7	5	M6	5A
7	E7	8	6	M7	6A
8	E8	9	7	M8	7A
9	E9	9A	8	M9	8A
10	E10	10	9	M10	9A
11	E11	11	10		10A
12	E12		11		11A
13					
14					
15		3			
16		4			
17					
18					
19					
20					
21	E21				
22	E22				
23	E23				
24	E24				
25	E25				
26	E26				
27	E27				
28	E28	28			
29	E29	29			
30	E30	30			
31	E31	31, 32			

TV system	B/G				
Country	Western Europe	Australia	New Zealand	Morocco	Indonesia
Channel number in the CHANNEL SET field	Corresponding channels				
32	E32	33			
33	E33	34			
34	E34	35			
35	E35	36			
36	E36	37			
37	E37	38			
38	E38	39, 40			
39	E39	41			
40	E40	42			
41	E41	43			
42	E42	44			
43	E43	45			
44	E44	46			
45	E45	47, 48			
46	E46	49			
47	E47	50			
48	E48	51			
49	E49	52			
50	E50	53			
51	E51	54			
52	E52	55, 56			
53	E53	57			
54	E54	58			
55	E55	59			
56	E56	60			
57	E57	61			
58	E58	62			
59	E59	63, 64			
60	E60	65			
61	E61	66			
62	E62	67			
63	E63	68			

continued

Manual setup — Presetting channels (continued)

TV system	B/G				
Country	Western Europe	Australia	New Zealand	Morocco	Indonesia
Channel number in the CHANNEL SET field	Corresponding channels				
64	E64	69			
65	E65				
66	E66				
67	E67				
68	E68				
69	E69				
C1	S1	5			
C2	S2				
C3	S3				
C4	S4				
C5	S5				
C6	S6	5A			
C7	S7				
C8	S8				
C9	S9		M4		
C10	S10		M5		
C11	S11				
C12	S12				
C13	S13				
C14	S14				
C15	S15				
C16	S16				
C17	S17				
C18	S18				
C19	S19				
C20	S20				
C21	S21				
C22	S22				
C23	S23				
C24	S24				
C25	S25				
C26	S26				
C27	S27				

TV system	B/G				
Country	Western Europe	Australia	New Zealand	Morocco	Indonesia
Channel number in the CHANNEL SET field	Corresponding channels				
C28	S28				
C29	S29				
C30	S30				
C31	S31				
C32	S32				
C33	S33				
C34	S34				
C35	S35				
C36	S36				
C37	S37				
C38	S38				
C39	S39				
C40	S40				
C41	S41				
C42	S01				
C43	S02				
C44	S03				
C45	S04				
C46	S05				

continued

Manual setup — Presetting channels (continued)

TV system	D/K		I			M	
Country	East Europe	China	UK/Hong Kong	Ireland	South Africa	U.S.A.	Japan
Channel number in the CHANNEL SET field	Corresponding channels						
1				A			
2	R1	1					
3		2		B		2, C2	
4		3		C		3	
5	R6	7		D	4	7	J-5
6	R7	8		E	5	8	J-6
7						9	J-7
8							
9						12	J-10
10						13	J-11
11						J	J-12
12	R12			J	10	K	S1
13	R2						
14	R3	4				5	
15	R4	5					
16	R5						
17	R8	9		F	6	10	J-8
18	R9	10		G	7	11	J-9
19	R10	11		H	8		
20	R11	12		I	9		
21	R21	13	B21		21	14, W+29, W+30	J13
22	R22	14	B22		22	15, 16, W+31	J14, J15
23	R23	15	B23		23	17, W+32	J16
24	R24	16	B24		24	18, W+33, W+34	J17
25	R25	17	B25		25	19, 20, W+35	J18, J19
26	R26	18	B26		26	21, W+36	J20
27	R27	19	B27		27	22, W+37, W+38	J21
28	R28	20	B28		28	23, 24, W+39	J22, J23
29	R29	21	B29		29	25, W+40	J24
30	R30	22	B30		30	26, W+41, W+42	J25
31	R31	23	B31		31	27, 28, W+43	J26, J27

TV system	D/K		I			M	
Country	East Europe	China	UK/Hong Kong	Ireland	South Africa	U.S.A.	Japan
Channel number in the CHANNEL SET field	Corresponding channels						
32	R32	24	B32		32	29, W+44	J28
33	R33		B33		33	30, W+45, W+46	J29
34	R34		B34		34	31, 32, W+47	J30, J31
35	R35		B35		35	33, W+48	J32
36	R36		B36		36	34, W+49, W+50	J33
37	R37		B37		37	35, 36, W+51	J34, J35
38	R38	25	B38		38	37, W+52	J36
39	R39	26	B39		39	38, W+53, W+54	J37
40	R40	27	B40		40	39, 40, W+55	J38, J39
41	R41	28	B41		41	41, W+56	J40
42	R42	29	B42		42	42, W+57, W+58	J41
43	R43	30	B43		43	43, 44	J42, J43
44	R44	31	B44		44	45	J44
45	R45	32	B45		45	46	J45
46	R46	33	B46		46	47, 48	J46, J47
47	R47	34	B47		47	49	J48
48	R48	35	B48		48	50	J49
49	R49	36	B49		49	51, 52	J50, J51
50	R50	37	B50		50	53	J52
51	R51	38	B51		51	54	J53
52	R52	39	B52		52	55, 56	J54, J55
53	R53	40	B53		53	57	J56
54	R54	41	B54		54	58	J57
55	R55	42	B55		55	59, 60	J58, J59
56	R56	43	B56		56	61	J60
57	R57	44	B57		57	62	J61
58	R58	45	B58		58	63, 64	J62
59	R59	46	B59		59	65	
60	R60	47	B60		60	66	
61		48	B61		61	67, 68	
62		49	B62		62	69	

continued

Manual setup — Presetting channels (continued)

TV system	D/K		I			M	
Country	East Europe	China	UK/Hong Kong	Ireland	South Africa	U.S.A.	Japan
Channel number in the CHANNEL SET field	Corresponding channels						
63		50	B63		63	70	
64		51	B64		64	71, 72	
65		52	B65		65	73	
66		53	B66		66	74	
67		54	B67		67	75, 76	
68		55	B68		68	77	
69		56	B69			78	
C1						A-3	J-3
C2						A-2, A-1	M1, M2
C3						A	M3
C4						B	M4
C5						C	M5
C6						D	M6
C7						E	M7
C8						F, G	M8, M9
C9						H	M10
C10		6				I	J-4
C11					11	L	S2
C12					(12)	M, N	S3
C13					13	O	S4
C14						P	S5, S6
C15						Q	S7
C16						R	S8
C17						S	S9
C18						T, U	S10, S11
C19						V	S12
C20						W	S13
C21						W+1, W+2	S14, S15
C22						W+3	S16
C23						W+4	S17
C24						W+5, W+6	S18, S19

TV system	D/K		I			M	
Country	East Europe	China	UK/Hong Kong	Ireland	South Africa	U.S.A.	Japan
Channel number in the CHANNEL SET field	Corresponding channels						
C25						W+7	S20
C26						W+8	S21
C27						W+9, W+10	S22, S23
C28						W+11	S24
C29						W+12	S25
C30						W+13, W+14	S26, S27
C31						W+15	S28
C32						W+16	S29
C33						W+17, W+18	S30, S31
C34						W+19	S32
C35						W+20	S33
C36						W+21, W+22	S34, S35
C37						W+23	S36
C38						W+24	S37
C39						W+25, W+26	S38, S39
C40						W+27	S40
C41						W+28	S41
C42						4, 4A	
C43							
C44						6	
C45						A-5	J-1
C46						A-4	J-2

Tip

- The shadow in the table shows the adjustable RF output channel range (see page 11 for reference).

Note

- There may be a case that the same area channel may appear repeatedly as the other channel number in the CHANNEL SET field.

Manual setup — Setting up G-CODE

G-CODE is a feature in Sony VCRs that simplifies programming the VCR to make timer recordings. To use G-CODE, each programme position needs to be matched with its G-CODE guide channel. To get the guide channel numbers, look in the programme guide for your area that features G-CODE numbers.

If you want to record satellite broadcasts using G-CODE, see page 34.

Before you start...

- Turn on the VCR and the TV.
- Set the TV to the video channel.

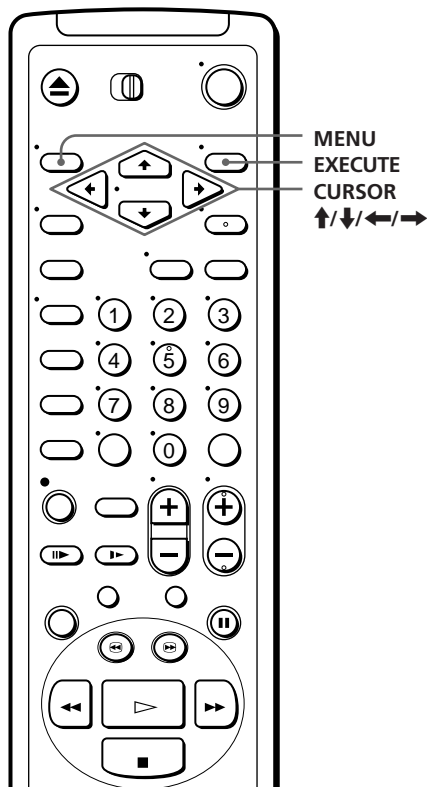

1

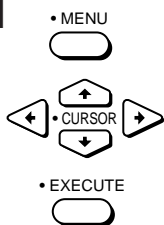

Press MENU, then press CURSOR \uparrow/\downarrow to move the cursor (▶) to SET UP CH AND G-CODE and press EXECUTE.

When using the EASY SET UP procedure, skip this step.

The preset channels are displayed on the screen.

SET UP CH AND G-CODE			
PROG	CH	GUIDE	CH
▶ 1	3	----	
2	9	----	
3	12	----	
4	27	----	
5	56	----	
SELECT : [\uparrow/\downarrow]			
MOVE PROG : [\star]			
ERASE PROG : [TIMER CLEAR]			

2

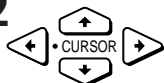

Press CURSOR \uparrow/\downarrow to move the cursor (▶) to the row on which you want to set the guide channel.

To display other pages for programme positions 6 to 50, press CURSOR \uparrow/\downarrow repeatedly.

SET UP CH AND G-CODE			
PROG	CH	GUIDE	CH
1	3	----	
2	9	----	
▶ 3	12	----	
4	27	----	
5	56	----	
SELECT : [\uparrow/\downarrow]			
MOVE PROG : [\star]			
ERASE PROG : [TIMER CLEAR]			

3

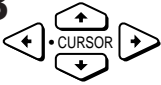

Press CURSOR \rightarrow twice to select the guide channel column.

SET UP CH AND G-CODE			
PROG	CH	GUIDE	CH
1	3	----	
2	9	----	
▶ 3	12	- [----]	
4	27	----	
5	56	----	
SELECT GUIDE CH		:	[♦♦]
CONFIRM		:	[♦♦]

4

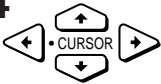

Press CURSOR \uparrow/\downarrow to select the guide channel number assigned in the programme guide.

SET UP CH AND G-CODE			
PROG	CH	GUIDE	CH
1	3	----	
2	9	----	
▶ 3	12	- [6]	
4	27	----	
5	56	----	
SELECT GUIDE CH		:	[♦♦]
CONFIRM		:	[♦♦]

5

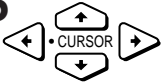

Press CURSOR \leftarrow/\rightarrow to confirm the setting.

SET UP CH AND G-CODE			
PROG	CH	GUIDE	CH
1	3	----	
2	9	----	
▶ 3	12	----	6
4	27	----	
5	56	----	
SELECT		:	[♦♦]
MOVE PROG		:	[♦]
ERASE PROG		:	[TIMER CLEAR]

6

To set the guide channel of another station, repeat steps 2 to 5.

If you want to change the programme positions of the stations, proceed to step 2 of "Manual setup — Changing/disabling programme positions" on page 35.

7



Press EXECUTE.

continued

Setting up G-CODE for satellite broadcasts

When your satellite tuner is connected via the AERIAL IN connector, first you have to set the programme position for each satellite channel using the TUNER PRESET menu. Then set the guide channel number for each satellite channel using the SET UP CH AND G-CODE menu.

If your satellite tuner is connected via the LINE-1 IN jacks, you don't have to set programme positions nor guide channel numbers for satellite channels. Skip the following operations.

- 1 Turn on the satellite tuner.
- 2 Press MENU, then select TUNER PRESET and press EXECUTE.
- 3 Press PROG +/- to select a programme position you want to use for watching a satellite channel.

- 4 Select CHANNEL SET, then press CURSOR → to tune the VCR to the satellite tuner.

The channel number displayed beside CHANNEL SET is used for receiving all satellite broadcasts from the satellite tuner.

TUNER PRESET		PROG6	
SYSTEM	• I	D/K	B/G M
NORMAL / CATV		• NORM	CATV
AUTO PRESET			
▶ CHANNEL SET		6	
AFT		• ON	OFF
FINE TUNING			
SELECT	:	[♦♦]	
SET	:	[♦♦]	

- 5 Press PROG +/- to select another programme position for another satellite channel, and press the programme number buttons to enter the same channel number as the one displayed in step 4.

Repeat this step for all satellite channels.

- 6 Set the guide channel number for each programme position assigned to the satellite channel, following the procedures in “Manual setup — Setting up G-CODE” on page 32.

Notes

- The G-CODE used in this VCR is for Singapore, Malaysia, Hong Kong, Macao, etc. and cannot be used in areas such as U.S.A, Canada, Japan, Korea, Taiwan, and U.K.
- If the preset channel is on cable TV, “C” appears on the left of the channel in step 1 (“Setting up G-CODE”) in most areas. However, this won't be applied in some areas (see pages 24 to 31 for reference).
- The menu disappears automatically if you don't proceed for more than a few minutes.
- If you inadvertently entered a guide channel number, press CURSOR ↑/↓ repeatedly to reset the “GUIDE CH” column to “---.” “---” appears between 1 and 255.
- The VCR does not allow entering the guide channel number, if the same number has been set.
- If you use a satellite tuner connected via the LINE-1 IN jacks, you don't have to setup G-CODE. Just record a satellite programme using G-CODE, and the VCR automatically records the programme from the LINE-1 IN jacks.
- When you record a satellite broadcast using G-CODE, you need to select the desired channel on the satellite tuner manually.

Manual setup — Changing/ disabling programme positions

After setting the channels and G-CODE guide channels, you can change the programme positions as you like. If any programme positions are unused or contain unwanted channels, you can disable them.

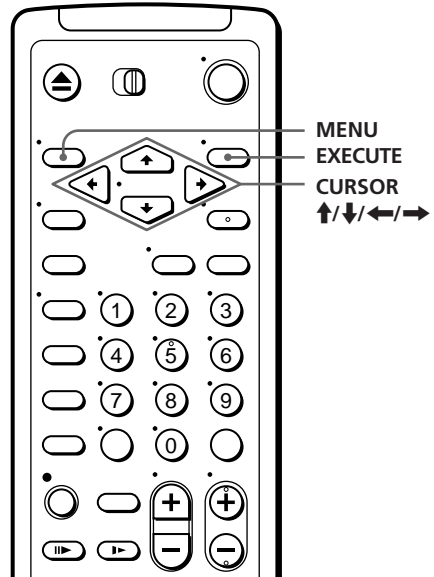

Before you start...

- Turn on the VCR and the TV.
- Set the TV to the video channel.

Changing programme positions

e.g. Moving the programme position from 4 to 1

1

• MENU



Press MENU, then press CURSOR \uparrow/\downarrow to move the cursor (\blacktriangleright) to SET UP CH AND G-CODE and press EXECUTE.

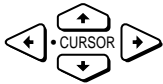

When using the EASY SET UP procedure, skip this step.

• EXECUTE



SET UP CH AND G-CODE			
PROG	CH	GUIDE	CH
\blacktriangleright 1	3	-	16
2	9	-	2
3	12	-	6
4	27	-	12
5	56	-	---
SELECT	:	[\blacktriangle]	
MOVE PROG	:	[\blacklozenge]	
ERASE PROG	:	[TIMER CLEAR]	

2

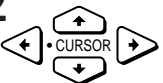

Press CURSOR \uparrow/\downarrow to move the cursor (\blacktriangleright) to the row on which you want to change the programme position, then press CURSOR \rightarrow .

To display other pages for programme positions 6 to 50, press CURSOR \uparrow/\downarrow repeatedly.

SET UP CH AND G-CODE			
PROG	CH	GUIDE	CH
1	3	-	16
2	9	-	2
3	12	-	6
\blacktriangleright 4	[27	-	12]
5	56	-	---
SELECT	:	[\blacktriangle]	
SET GUIDE CH	:	[\blacklozenge]	
CONFIRM	:	[\blacklozenge]	

continued

Manual setup — Changing/disabling programme positions (continued)

3

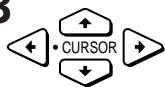

Press CURSOR \uparrow/\downarrow until the selected channel and guide channel row moves to the desired programme position.

The selected channel and guide channel are inserted at the new programme position and the intermediate channels are displaced to fill the gap.

SET UP CH AND G-CODE			
PROG	CH	GUIDE	CH
▶ 1	27	-	12
2	3	-	16
3	9	-	2
4	12	-	6
5	56	-	---
SELECT	:	[♦♦]	
SET GUIDE CH	:	[♦]	
CONFIRM	:	[♦]	

4

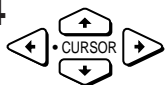

Press CURSOR \leftarrow to confirm the setting.

5

To change the programme position of another station, repeat steps 2 to 4.

6



Press EXECUTE.

Disabling unwanted programme positions

Note

- Be sure to select the programme position you want to disable correctly. If you disable a programme position by mistake, you need to reset that channel manually.

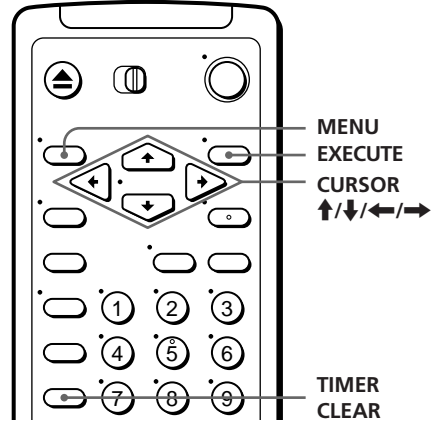

1

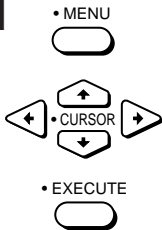

Press MENU, then press CURSOR ↑/↓ to move the cursor (▶) to SET UP CH AND G-CODE and press EXECUTE.

When using the EASY SET UP procedure, skip this step.

SET UP CH AND G-CODE			
PROG	CH	GUIDE	CH
▶ 1	3	-	16
2	9	-	2
3	12	-	6
4	27	-	12
5	56	-	---
SELECT : [♦♦]			
MOVE PROG : [♦]			
ERASE PROG : [TIMER CLEAR]			

2

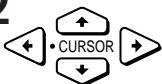

Press CURSOR ↑/↓ to move the cursor (▶) to the row on which you want to disable.

SET UP CH AND G-CODE			
PROG	CH	GUIDE	CH
1	3	-	16
2	9	-	2
▶ 3	12	-	6
4	27	-	12
5	56	-	---
SELECT : [♦♦]			
MOVE PROG : [♦]			
ERASE PROG : [TIMER CLEAR]			

3



Press TIMER CLEAR.

The selected row will be cleared as shown on the right.

SET UP CH AND G-CODE			
PROG	CH	GUIDE	CH
1	3	-	16
2	9	-	2
▶ 3	0	-	---
4	27	-	12
5	56	-	---
SELECT : [♦♦]			
MOVE PROG : [♦]			
ERASE PROG : [TIMER CLEAR]			

4

Repeat steps 2 and 3 for any other programme positions you want to disable.

5



Press EXECUTE.

Manual setup — Setting the clock

You must set the time and date on the VCR to be able to use the timer recording features properly. If you have not set the VCR clock in the EASY SET UP procedure, you need to set it manually.

Before you start...

- Turn on the VCR and the TV.
- Set the TV to the video channel.

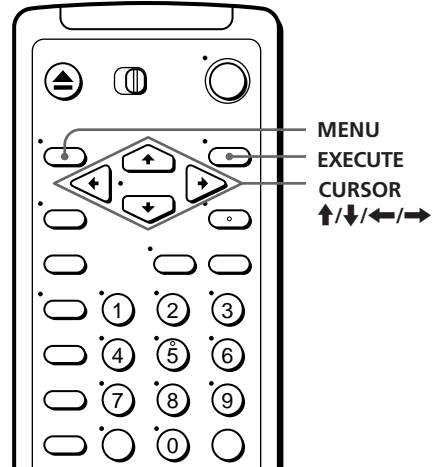

1 Press MENU, then press CURSOR \uparrow/\downarrow to move the cursor (\blacktriangleright) to CLOCK SET and press EXECUTE.

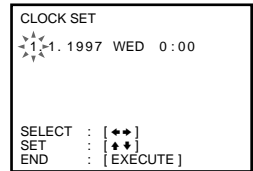
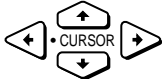

2 Press CURSOR \uparrow/\downarrow to set the date. The day of the week is set automatically.

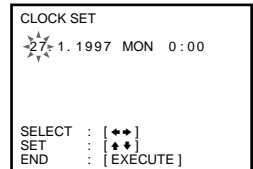
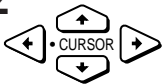

3 Press CURSOR \rightarrow to select the month and set the month using CURSOR \uparrow/\downarrow .

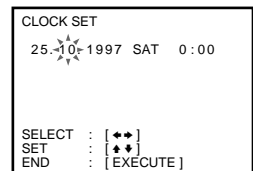
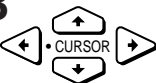

4

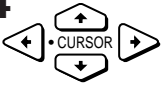

Set the year, hour and minutes in sequence, using CURSOR \rightarrow to select the item to be set, and CURSOR \uparrow/\downarrow to select the digits.

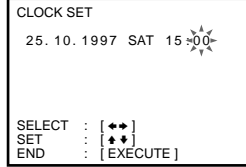

5



Press EXECUTE to start the clock.

Tip

- To change the digits during setting, press CURSOR \leftarrow to return to the item to be changed, and select the digits using CURSOR \uparrow/\downarrow .

Note

- The menu disappears automatically if you don't proceed for more than a few minutes.

Playing a tape

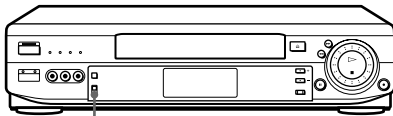

COLOR SYSTEM switch

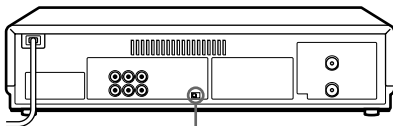

NTSC PB switch

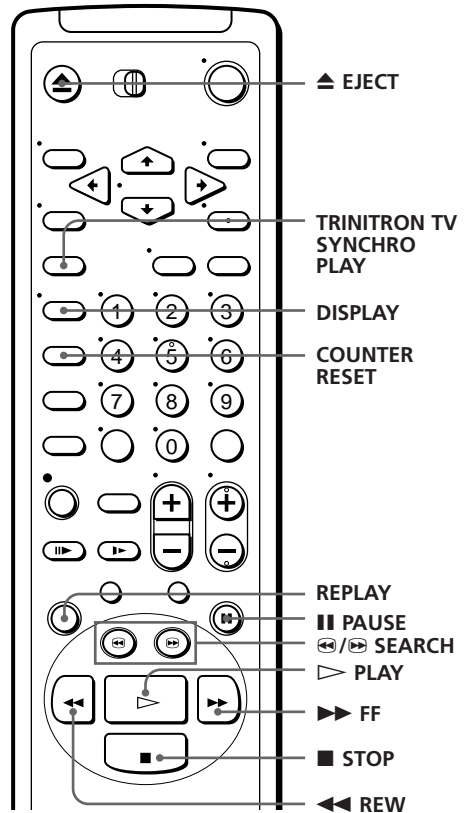

1 Turn on your TV and set it to the video channel.

2 Insert a tape.
The VCR turns on and starts playing automatically if you insert a tape with its safety tab removed.

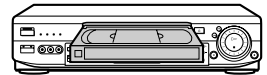

3 Press  PLAY.

When the tape reaches the end, it will rewind automatically.

Additional tasks

To	Press
Stop play	■ STOP
Pause play	PAUSE
Resume play after pause	PAUSE or ▷ PLAY
Search forward	▶▶ FF or 🔍 SEARCH during playback
Search backward	◀◀ REW or 🔍 SEARCH during playback
Fast-forward the tape	▶▶ FF during stop
Rewind the tape	◀◀ REW during stop
Eject the tape	⬆ EJECT

To replay a recently watched scene

You can immediately rewind and playback the scene you want to watch again.

During playback, press REPLAY up to four times. The VCR rewinds the tape about 10 seconds on the counter for each press of the button, and restarts playback.

To set the colour system

If streaks appear during playback, set COLOR SYSTEM on the VCR to conform to the system that the tape was recorded in. (When you select AUTO, normally, the colour system is correctly set whenever the tape is inserted.)

If your tape was recorded in	Set COLOR SYSTEM to
PAL	PAL/MESECAM
NTSC	NTSC
MESECAM	PAL/MESECAM

To play an NTSC-recorded tape

Set NTSC PB at the rear of the VCR according to the colour system of your TV.

If your TV is	Set NTSC PB to
PAL	ON PAL TV
NTSC 4.43	NTSC 4.43
NTSC 3.58	NTSC 3.58

continued

Playing a tape (continued)

To use the time counter

At the point on the tape that you want to find later, press COUNTER RESET. The counter in the display window resets to "0H00M00S." Search for the point afterwards by referring to the counter.



To display the counter on the TV screen, press DISPLAY.

Notes

- When you play back a tape recorded in the PAL or MESECAM colour system, streaks may appear even if the COLOR SYSTEM switch is set to PAL/MESECAM. If so, select the colour system, PAL or MESECAM in the PAL/MESECAM option of the SET UP MENU (see page 62 for details).
- The counter resets to "0H00M00S" whenever a tape is reinserted.
- The counter stops counting when it comes to a portion with no recording.
- If a tape has portions recorded in both PAL and NTSC systems, the time counter reading will not be correct. This is due to the difference between the counting cycles of the two video systems.
- Depending on your TV, the following may occur while playing an NTSC-recorded tape:
 - the picture is black and white,
 - the picture shakes,
 - no picture appears on the TV screen,
 - black streaks appear horizontally on the TV screen,
 - the colour density increases or decreases.

Turning on the VCR and TV, and starting playback automatically (Trinitron TV Synchro Play)

You can only use this function if your TV is made by Sony (Trinitron TV).

How to connect to use this function

Connect the VCR and TV with the audio/video cable (see “To a TV that has phono type audio/video input jacks” on page 9). Be sure to connect the audio/video cable to the VIDEO IN 1 jacks on the TV if the TV has two inputs or more. The TV must be placed where it will respond to the remote commander while you are pointing it at the VCR.

Operation

Make sure that the TV's power is in standby mode.

Press TRINITRON TV SYNCHRO PLAY and hold the remote commander in place for about two seconds.

The VCR and TV turn on, and the TV is set to the video channel. If there is a tape in the VCR, playback starts automatically.

Notes

- If the Trinitron TV Synchro Play function does not work properly:
 - Wait a few moments, and press the button again.
 - Replace both of the batteries with new ones, and press the button again.Note that this function may not operate some Sony TVs because of the remote commander's signal limitations.
- Do not press TRINITRON TV SYNCHRO PLAY while playing back a video tape. If you do so, the TV's input source will momentarily switch to the TV's tuner.

Recording TV programmes

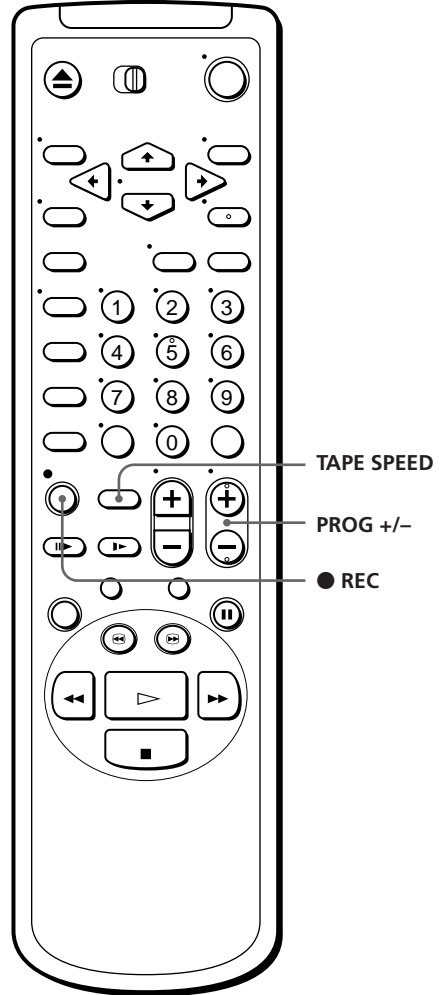

-
- 1** Turn on your TV and set it to the video channel.

 - 2** Insert a tape with its safety tab in place.

3

• PROG



Press PROG +/- to select the programme position you want to record.

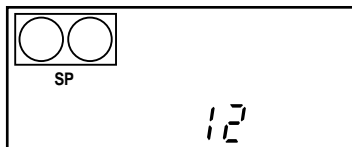

4

TAPE
SPEED

Press TAPE SPEED to select the tape speed (SP or LP for the PAL colour system, and SP or EP for the NTSC colour system).

LP provides recording time twice as long as SP. EP provides recording time three times as long as SP. However, SP produces better picture and audio quality.

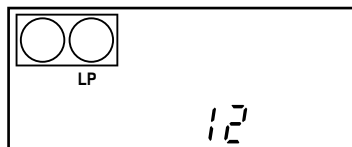

5

● REC



Press ● REC to start recording.

To stop recording

Press ■ STOP.

To check the remaining tape length (except for NTSC recorded tapes)

Press DISPLAY. The white bar indicates the approximate length of tape remaining.

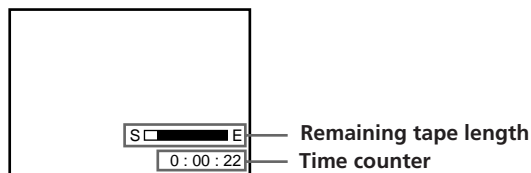

continued

Recording TV programmes (continued)

To watch another TV programme while recording

- 1 If the TV is connected to the VCR using an audio/video cable, set the TV to TV input. If the TV is connected to the VCR using only the aerial cable, skip this step.
- 2 Select another programme position on the TV.

To save a recording

To prevent accidental erasure, break off the safety tab as illustrated. To record on a tape again, cover the tab hole with adhesive tape.

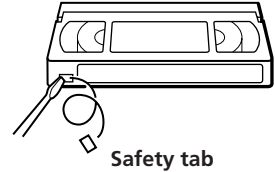

Tips

- To select a programme position, you can use the programme number buttons on the remote commander. For two-digit numbers, press the -- (ten's digit) button followed by the programme number buttons.
- You can select a video source from the LINE-1 IN or the LINE 2 IN jacks using the INPUT SELECT button.
- The display appears on the TV screen indicating information about the tape, but the information won't be recorded on the tape.
- If you don't want to watch TV while recording, you can turn off the TV.

Note

- When you play back a tape recorded in the PAL or MESECAM colour system, streaks may appear even if the COLOR SYSTEM switch is set to PAL/MESECAM. If so, select the colour system PAL or MESECAM in the PAL/MESECAM option of the SET UP MENU (see page 62 for details).

Recording TV programmes using G-CODE

Just enter the programme's G-CODE number listed in the TV programme guide. The date, times and programme position of that programme are set automatically. You can preset up to eight programmes at a time.

Before you start...

- Check that the VCR clock is set to the correct time.
- Insert a tape with its safety tab in place. Make sure the tape is longer than the total recording time.
- Turn on your TV and set it to the video channel.

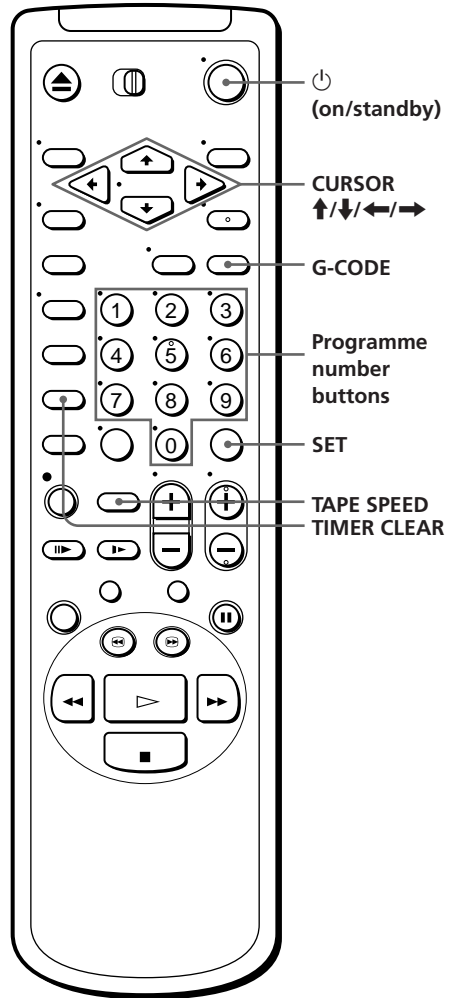

1



Press G-CODE.

G-CODE	
G-CODE No. [-----]	SP / LP [SP]
SET : [0-9]	
SP / LP : [TAPE SPEED]	

continued

Recording TV programmes using G-CODE (continued)

2

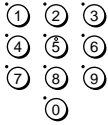

Press the programme number buttons to enter the programme's G-CODE number.

If you make a mistake, press TIMER CLEAR and re-enter the correct number.

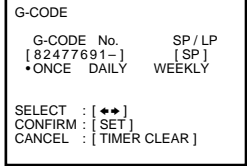

3



Press TAPE SPEED to select the tape speed, SP or LP.

To set the EP mode for the NTSC colour system, display "LP" in the tape speed position.

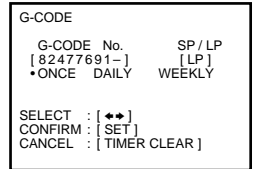

4

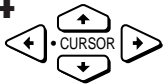

Select ONCE, DAILY or WEEKLY by using CURSOR \leftarrow / \rightarrow , then press SET:



To record	Select
Only once	ONCE
Everyday Monday to Friday	DAILY
Once a week	WEEKLY

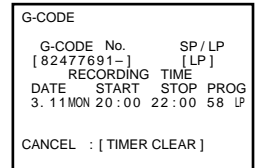

The date, start and stop times, programme position, and tape speed appear on the TV screen.

If the information is not correct, press TIMER CLEAR to cancel the setting.

5

To enter another setting, repeat steps 1 to 4.

6



Press $\text{\textcircled{P}}$ to turn off the VCR.

The TIMER indicator appears in the display window and the VCR stands by for recording.

To stop recording



To stop the VCR while recording, press \blacksquare STOP.

To record satellite broadcasts

If you connect the satellite tuner and the VCR, you can record satellite programmes.

- 1** Turn on the satellite tuner.
- 2** On the satellite tuner, select the satellite programme for which you wish to make a timer setting.
- 3** Follow the steps on pages 47 and 48.
- 4** Keep the satellite tuner turned on until the VCR finishes recording the satellite programme for which you have made a timer setting.

To use the VCR after setting the timer

To use the VCR before a timer recording begins, just press . The TIMER indicator turns off and the VCR switches on. Remember to press  to reset the VCR after using the VCR.

You can also do the following tasks while the VCR is recording:

- Reset the counter.
- Display tape information on the TV screen.
- Check the timer settings.
- Watch another TV programme.

Tip

- To cancel the procedure, press G-CODE before pressing SET.

Notes

- The G-CODE used in this VCR is for Singapore, Malaysia, Hong Kong, Macao, etc. and cannot be used in areas such as U.S.A., Canada, Japan, Korea, Taiwan, and U.K.
- If the VCR beeps repeatedly, this means that:
 - The G-CODE number is incorrect.
 - ONCE, DAILY, or WEEKLY was selected incorrectly. You cannot select DAILY or WEEKLY for a programme that airs more than seven days ahead.

Setting the timer manually

The VCR automatically starts and stops recording TV programmes. You can preset up to eight programmes at a time.

Before you start...

- Check that the VCR clock is set to the correct time.
- Insert a tape with its safety tab in place. Make sure the tape is longer than the total recording time.
- Turn on your TV and set it to the video channel.

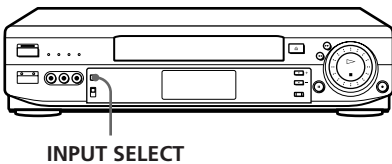
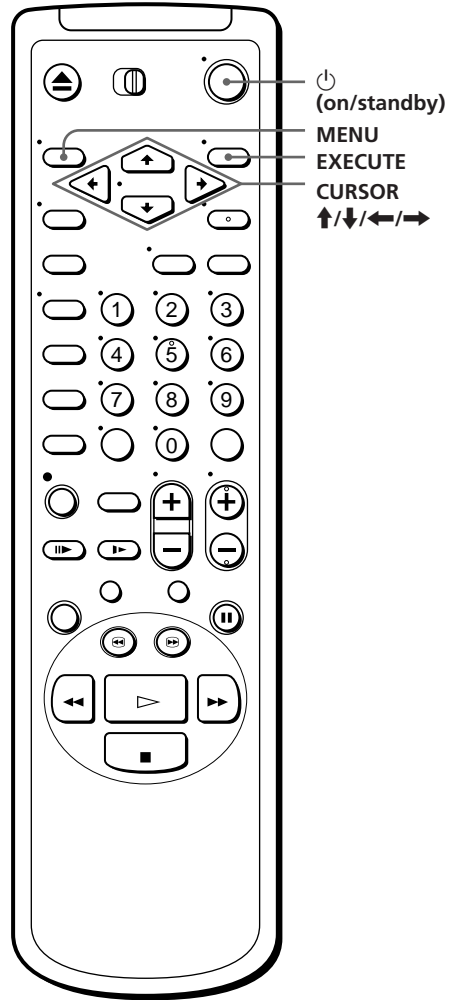

1

- MENU
- CURSOR
- EXECUTE

Press MENU and select TIMER SET / CHECK, then press EXECUTE.

TIMER SET / CHECK	25 .10	SAT
DATE	START	STOP
PROG		
▶---	----	----
----	----	----
----	----	----
----	----	----
----	----	----
----	----	----
----	----	----
----	----	----
----	----	----

2

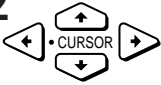

Set the date, start and stop times, programme position, and tape speed:

1 Press CURSOR → to select each item in turn.

2 Press CURSOR ↑/↓ to set each item.

To correct a setting, press CURSOR ← to return to that setting and reset.

To record the same programme every day or the same day every week, press CURSOR ↓ while the date is flashing. For details, see “Daily/weekly recording” below.

To record from a source connected to the LINE-1 IN or the LINE 2 IN jacks, press INPUT SELECT to display “L1” or “L2” in the “PROG” position.

TIMER SET /CHECK	25 . 10 SAT		
DATE	START	STOP	PROG
▶ 19 . THWED	---	---	---
22 . FRI	---	---	---
---	---	---	---
---	---	---	---
---	---	---	---
---	---	---	---
---	---	---	---
---	---	---	---
---	---	---	---

3

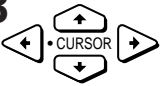

Press CURSOR → to confirm the setting.

To enter another setting, move the cursor to the next line and repeat step 2.

4



Press EXECUTE.

5



Press  to turn off the VCR.

The TIMER indicator appears in the display window and the VCR stands by for recording.

To record from other equipment, leave the connected equipment switched on.

To stop recording

To stop the VCR while recording, press ■ STOP.

Daily/weekly recording



In step 2 above, press CURSOR ↓ to select the recording pattern. Each time you press CURSOR ↓, the indication changes as shown below. Press CURSOR ↑ to change the indication in reverse order.

the current date → SUN-SAT → MON-SAT → MON-FRI → EVERY SAT
 → EVERY MON → EVERY SUN → 1 month later → (dates count down)
 → the current date

continued

Setting the timer manually (continued)

To use the VCR after setting the timer

To use the VCR before a timer recording begins, just press . The TIMER indicator turns off and the VCR switches on. Remember to press  to reset the VCR after using the VCR.

You can also do the following tasks while the VCR is recording:

- Reset the counter.
- Display tape information on the TV screen.
- Check the timer settings.
- Watch another TV programme.

Tips

- To set the programme position, you can also use the PROG +/- or programme number buttons.
- To set the tape speed, you can also use the TAPE SPEED button.
- To record NTSC signals, set the tape speed to SP or EP. To set the EP mode, display "LP" in the tape speed position.

Note

- "TIMER" flashes in the display window when you press  with no tape inserted.

Playing/searching at various speeds

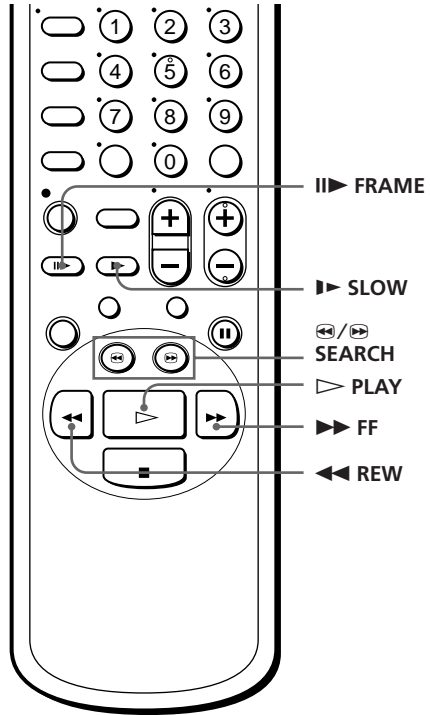

Playback options	Operation
Fast-forward/rewind	During stop, press ►► FF or ◀◀ REW.
View the picture during fast-forward or rewind	During fast-forward, hold ►► FF down. During rewind, hold ◀◀ REW down.
Play at high speed	During playback or pause, press 🔍 SEARCH or 🔍 SEARCH. To change direction, press the other one.
Play in slow motion for two minutes	During playback or pause, press ► SLOW.
Play frame by frame	During pause, press II ► FRAME. Hold the button down to play one frame each second.
Rewind to the beginning of a tape and start play	During stop, hold ◀◀ REW down <u>on the VCR</u> , and press ▷ PLAY <u>on the VCR</u> .

To resume normal playback

Press ▷ PLAY.

continued

Playing/searching at various speeds (continued)

Using the CLICK SHUTTLE ring

With the CLICK SHUTTLE ring on the VCR you can operate a variety of playback options.

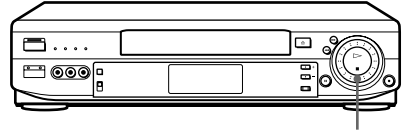

CLICK SHUTTLE ring

During playback or pause, turn the CLICK SHUTTLE ring clockwise or counterclockwise. Each change in the CLICK SHUTTLE ring position changes the playback mode, and the corresponding mark appears on the TV screen for a few seconds in the following way if the on-screen display function is on.

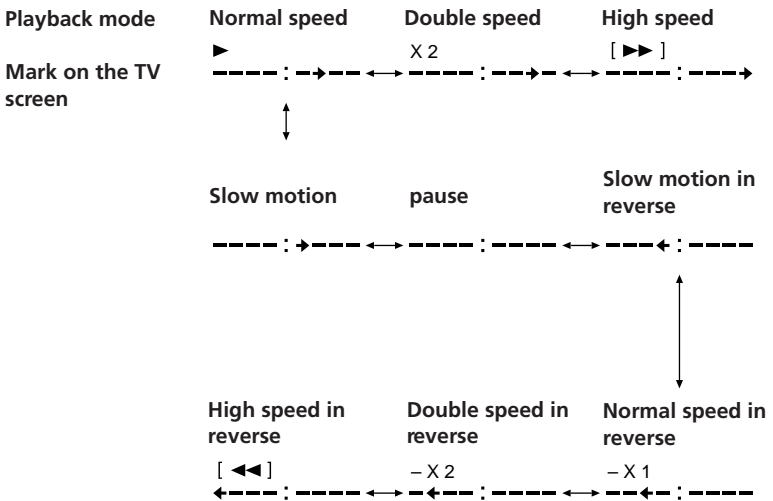

Tip

- Adjust the picture using TRACKING +/- on the VCR if:
 - streaks appear while playing in slow motion.
 - bands appear at the top or bottom while pausing.
 - the picture shakes while pausing.

Notes

- The playback sound is muted during these operations.
- In the LP mode, noise may appear or there may be no colour.
- If the playback mode mark doesn't appear on the TV screen, press DISPLAY.
- The playback mode mark may shake while playing or searching at various speeds.

Recording TV programmes using the quick timer

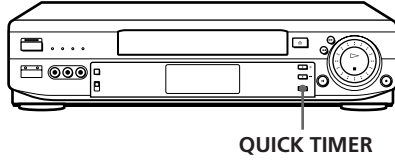

After starting recording in the normal way, you can have the VCR stop recording automatically after a specified duration.

- 1 While recording, press QUICK TIMER on the VCR once.



- 2 Press QUICK TIMER repeatedly to set the duration.
Each press advances the time in increments of 30 minutes.

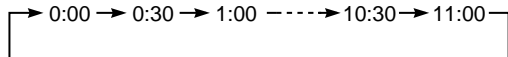

The duration decreases minute by minute to 0:00, then the VCR stops recording and turns off automatically.

To extend the duration

Press QUICK TIMER repeatedly to set to the new duration.

To stop recording

To stop the VCR while recording, press ■ STOP.

Tip

- You can also set the quick timer and start recording during the stop mode.

Checking/ changing/ cancelling timer settings

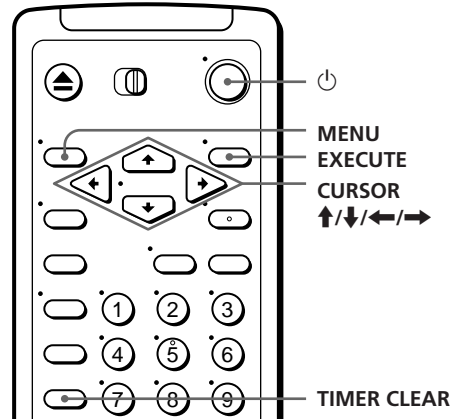

Before you start...

- Turn on your TV and set it to the video channel.

- 1 Press to turn on the VCR.
- 2 Press MENU, then select TIMER SET/CHECK:
 - If you want to change a setting, go on to the next step.
 - If you do not need to change the settings, press EXECUTE, then turn off the VCR to return to recording standby.

TIMER SET / CHECK	25.10	SAT
DATE	START	STOP PROG
▶ 2.11SUN	7:00	8:00 6 SP
4.11TUE	21:00	0:00 50 LP
MON-SAT	12:12	13:00 27 LP
EVERY SUN	23:00	0:00 L1 SP
---	---	---
---	---	---
---	---	---
---	---	---

- 3 Press CURSOR to select the setting you want to change or cancel:
 - To change the setting, press CURSOR to select the item you want to change, and press CURSOR to reset it. Then, press CURSOR repeatedly until the cursor (▶) appears at the beginning of the line.
 - To cancel the setting, press TIMER CLEAR.
- 4 Press EXECUTE.

If any settings remain, turn off the VCR to return to recording standby.

When the timer settings overlap

The programme that starts first has priority and the second programme starts recording only after the first programme has finished. If the programmes start at the same time, the programme listed first in the menu has priority.

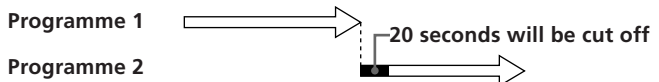
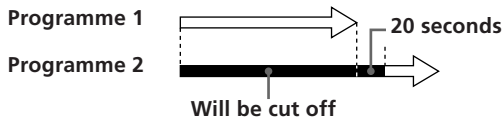

Recording stereo and bilingual programmes

In ZWEITON (German stereo) system

This VCR automatically receives and records stereo and bilingual programmes based on the ZWEITON system only when the SYSTEM (I, D/K, B/G, or M) option in the TUNER PRESET menu is set to B/G. When a stereo or bilingual programme is received, the STEREO indicator appears in the display window.

To select bilingual sound while recording

Press AUDIO MONITOR to select the sound you want.

To listen to	On-screen display	Display window
Main	MAIN	L
Sub	SUB	R
Main and sub	MAIN/SUB	L, R

In NICAM system

This VCR receives and records stereo and bilingual programmes based on the NICAM system (the NICAM indicator appears). When a stereo or bilingual programme is received, the STEREO indicator appears in the display window.

To record a NICAM programme, HIFI AUDIO in the SET UP MENU should be set to NICAM (initial setting). To check the menu setting, see page 62 for details.

To select the sound while recording

Press AUDIO MONITOR to select the sound you want.

Stereo programme

To listen to	On-screen display	Display window
Stereo	STEREO	STEREO
Standard sound*	No indicator	No indicator

* Usually the mixed sound of left and right channels (monaural)

continued

Recording stereo and bilingual programmes (continued)

Bilingual programme

To listen to	On-screen display	Display window
Main	MAIN	L
Sub	SUB	R
Main and sub	MAIN/SUB	L, R
Standard sound*	No indicator	No indicator

* Usually the main sound (monaural)

Selecting the sound during playback

Press AUDIO MONITOR to select the sound you want.

Stereo programme

To listen to	On-screen display	Display window
Stereo	STEREO	L, R STEREO
Left channel	LCH	L, STEREO
Right channel	RCH	R, STEREO
Standard sound*	No indicator	No indicator

* Usually the mixed sound of the left and right channels

Bilingual programme

To listen to	On-screen display	Display window
Main	MAIN	L, STEREO
Sub	SUB	R, STEREO
Main and sub	MAIN/SUB	L, R STEREO
Standard sound*	No indicator	No indicator

* Usually the main sound (monaural)

To check audio channel and sound level

You can check the audio channel and sound level visually with the indicators in the display window.

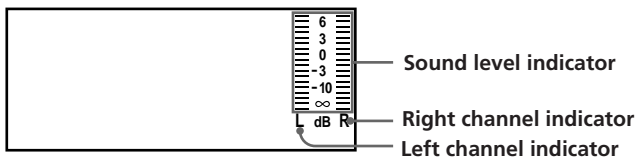

How sound is recorded on a video tape

The VCR records sound onto two separate tracks. Hi-fi audio is recorded onto the main track along with the picture. Monaural sound is recorded onto the normal audio track along the edge of the tape.

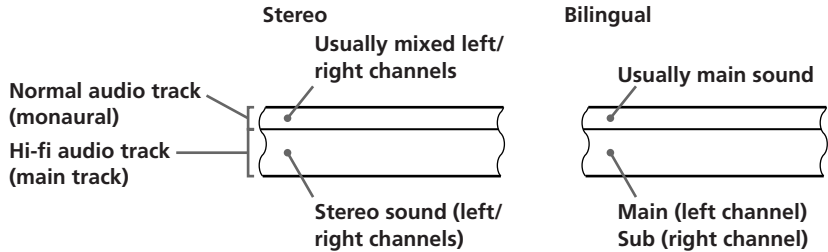

Notes

- To play a tape in stereo, you must use the AUDIO OUT connections.
- When you play a tape recorded in monaural, the sound is heard in monaural regardless of the AUDIO MONITOR setting.
- If the AUDIO MONITOR button does not function, check that AUDIO MIX in the SET UP MENU is set to OFF.
- If HIFI AUDIO is set to STD, the standard sound will be recorded on both the hi-fi and normal audio tracks. Pressing AUDIO MONITOR will not change the sound.

Searching with the index function

You can search for the start of a specific passage or scene.

The VCR can search up to 99 index signals ahead of or behind the current position.

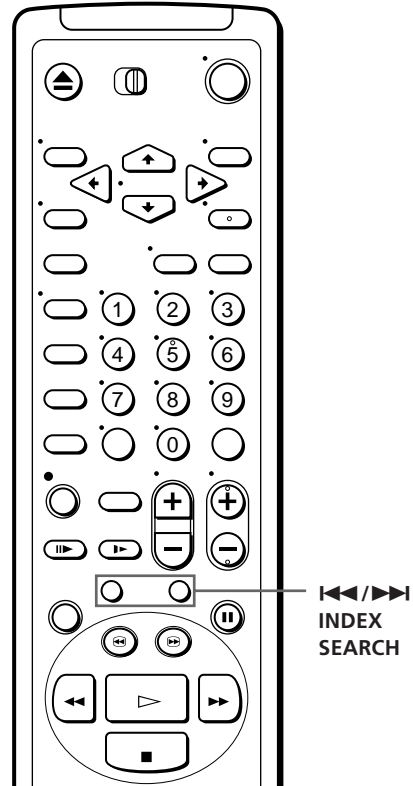

- 1 Insert an indexed tape into the VCR.
- 2 Press **◀◀ / ▶▶** INDEX SEARCH repeatedly to specify how many index signals ahead or behind you want to search:
 - To search ahead, press **▶▶** INDEX SEARCH.
 - To search backwards, press **◀◀** INDEX SEARCH.

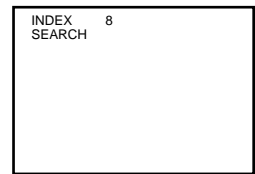

The VCR starts searching and the index number on the TV screen counts down to zero. Playback starts automatically from that point.

To stop searching

Press **■** STOP.

Note

- No index signal will be added when recording starts from recording pause. However, an index signal will be marked if you change the channel during recording pause.

Adjusting the picture

Adjusting the tracking

Although the VCR automatically adjusts the tracking when playing a tape (the tracking indicator  flashes in the display window, then goes off), distortion may occur if the tape was recorded in poor condition. If so, manually adjust the tracking.

Press TRACKING +/- on the VCR to display the tracking meter. The distortion should disappear as you press one of the two buttons (the  indicator lights up). To resume automatic tracking adjustment, eject the tape and reinsert it.

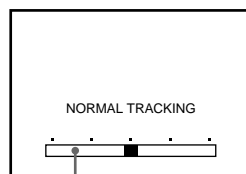

Tracking meter

About Adaptive Picture Control (APC)

Adaptive Picture Control (APC) automatically improves recording and playback quality by adjusting the VCR to the condition of the video heads and tape. To maintain better picture quality, we recommend that you set APC to ON in the SET UP MENU (with the APC indicator in the display window lit).

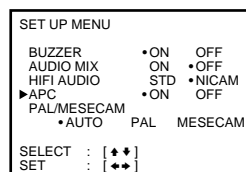

APC playback

The APC function automatically works on all types of tapes, including rental tapes and tapes that were not recorded with APC.



APC recording

Whenever you insert a tape and start recording for the first time, the VCR adjusts to the tape using the APC function (the APC indicator flashes rapidly). This adjustment is retained until the tape is ejected.

To deactivate the APC

Press MENU and select SET UP MENU, then set APC to OFF. The APC indicator in the display window goes off.

Note

- There is a delay of a few seconds before the VCR actually starts recording while the VCR analyses the tape. To avoid the delay, first set the VCR to recording pause (the APC indicator flashes slowly) and press  REC to have the VCR analyse the tape (the APC indicator flashes rapidly). After the APC indicator stops flashing, press  PAUSE to start recording immediately. If you want to start recording quickly without using the APC function, first set the VCR to recording pause (the APC indicator flashes slowly) and press  PAUSE to start recording.

Changing menu options

- 1 Press MENU, then select SET UP MENU.

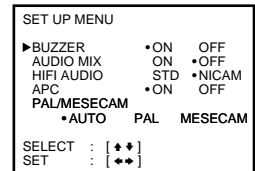

- 2 Press CURSOR **↑/↓** to select the option to change, then press CURSOR **←/→** to change the setting.
- 3 Press EXECUTE to return to the original screen.

Menu choices

Initial settings are indicated in bold print.

Menu option	Set this option to
BUZZER	<ul style="list-style-type: none"> • ON to output a beep sound when all illogical operation is made. • OFF to deactivate it.
AUDIO MIX	<ul style="list-style-type: none"> • ON to listen to the hi-fi and normal audio tracks at the same time. The AUDIO MONITOR button will not function. • OFF to listen to hi-fi and normal audio tracks separately. Select the sound using the AUDIO MONITOR button. <p>For details, see page 59.</p>
HIFI AUDIO	<ul style="list-style-type: none"> • STD to record standard sound on the hi-fi audio track. • NICAM to record NICAM broadcasts on the hi-fi audio track. <p>For details, see page 57.</p>
APC	<ul style="list-style-type: none"> • ON to switch on the APC (Adaptive Picture Control) function and improve picture quality. • OFF to switch off APC. <p>For details, see page 61.</p>
PAL/MESECAM	<ul style="list-style-type: none"> • AUTO to record/play back in the colour system selected automatically. Normally, select AUTO. • PAL to record/play back in the PAL colour system. • MESECAM to record/play back in the MESECAM colour system. <p>For details, see page 42.</p>

Connecting to a VCR or stereo system

How to connect to record on this VCR

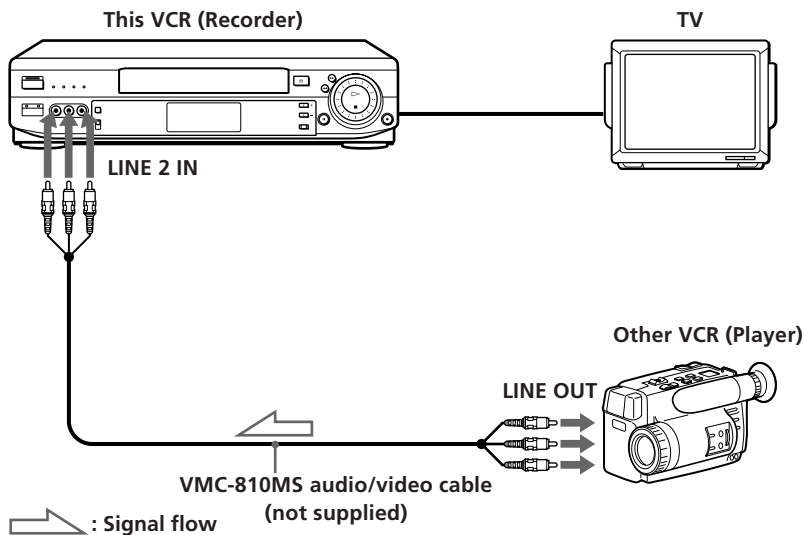

Tip

- You can also use the LINE-1 IN jacks instead.

Notes

- Make sure you connect the plugs to jacks of the same colour.
- If the other VCR is a monaural type, connect the audio plug to the AUDIO L (white) jack. The sound is recorded on both right and left channels. When connecting to the AUDIO R (red) jack, the sound is recorded only on the right channel.
- If you connected this VCR to both the LINE IN and LINE OUT jacks of the other VCR, select the input correctly to prevent a humming noise.

How to connect to a stereo system

Connect LINE 2 IN AUDIO on this VCR to the audio output jacks on the stereo system, using the RK-C510KS audio cable (not supplied).

Basic editing

(when recording on this VCR)

Before you start editing

- Turn on your TV and set it to the video channel.
- Press INPUT SELECT to display “L2” (or “L1”) in the display window.
- Press TAPE SPEED on the remote commander to select the tape speed (SP or LP for the PAL system, and SP or EP for the NTSC system).

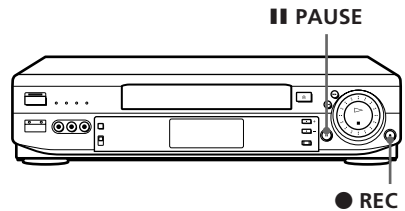

- 1** Insert a source tape with its safety tab removed into the other (playback) VCR. Search for the point to start playback and set it to playback pause.
- 2** Insert a tape with its safety tab in place into this (recording) VCR. Search for the point to start recording and press **|| PAUSE**.
- 3** Press **● REC** on this VCR and set it to recording pause.
- 4** To start editing, press the **|| PAUSE** buttons on both VCRs at the same time.

To stop editing

Press the **■ STOP** buttons on both VCRs.

Tips

- To edit more precisely, press the **|| PAUSE** buttons on the VCRs to release pause.
- To cut out unwanted scenes while editing, press **|| PAUSE** on this VCR when an unwanted scene begins. When it ends, press **|| PAUSE** again to resume recording (Assemble Editing).

Note

- If you start recording following the procedure above, the VCR won't start recording with the APC function. To record a tape with the APC function, press **● REC** again during recording pause in step 3 so that the VCR analyses the tape. Then when you start recording in step 4, press **|| PAUSE** after the APC indicator stops flashing. If you press **|| PAUSE** before the APC indicator stops flashing, the APC function is cancelled.

Troubleshooting

If you have any questions or problems not covered below, please consult your nearest Sony service facility.

	Symptom	Remedy
Power	The ON/STANDBY switch does not function.	<ul style="list-style-type: none"> Connect the mains lead to mains securely.
	The power is turned on but the VCR does not operate.	<ul style="list-style-type: none"> Moisture condensation occurs. Turn the power off, unplug the mains lead and leave the VCR to dry for over one hour.
Clock	The clock has stopped and “-:-” lights in the display window.	<ul style="list-style-type: none"> The clock stops if the VCR is disconnected from the mains for more than an hour. Reset the clock (and timer).
	The playback picture does not appear on the TV screen.	<ul style="list-style-type: none"> Make sure the TV is set to the video channel. If you are using a monitor, set it to video input.
Playback	The picture is not clear.	<ul style="list-style-type: none"> Adjust the tracking with the TRACKING +/- buttons. Make sure the colour system is correctly set to the system that the tape was recorded in. The video heads are dirty (see below). Clean the video heads using the Sony V-25CL video head cleaning cassette. If this cleaning cassette is not available in your area, have the heads cleaned at your nearest Sony service facility (a standard service charge will be required). Do not use a commercially available liquid-type cleaning cassette, as it may damage the video heads. The video heads may have to be replaced. Consult your local Sony service facility for more information.

Symptoms caused by contaminated video heads

- Normal picture
- Rough picture
- Unclear picture
- No picture (or black & white screen appears)



initial
contamination



terminal

continued

Troubleshooting (continued)

	Symptom	Remedy
Playback	The picture rolls vertically during picture search.	<ul style="list-style-type: none"> Adjust the vertical hold control on the TV or monitor.
	The picture has no sound.	<ul style="list-style-type: none"> The tape is defective. Use a new tape.
	The sound is unstable or has an echo.	<ul style="list-style-type: none"> When you play a tape with the same sound recorded on both the hi-fi and normal sound tracks, make sure the AUDIO MIX option in the SET UP MENU is set to OFF.
Recording	No TV programmes appear on the TV screen.	<ul style="list-style-type: none"> Make sure the TV is set to the video channel. If you are using a monitor, set it to video input.
	TV reception is poor.	<ul style="list-style-type: none"> Adjust the TV aerial. Make sure SYSTEM, I, D/K, B/G, or M in the TUNER PRESET menu is set to the system in your area.
	The tape starts playing as soon as it is inserted.	<ul style="list-style-type: none"> The safety tab has been removed. To record on this tape, cover the tab hole.
	The tape is ejected when you press ● REC.	<ul style="list-style-type: none"> Check that the safety tab has not been removed.
	Nothing happens when you press ● REC.	<ul style="list-style-type: none"> Make sure the tape is not at its end. Select the correct source. Select a programme position with the PROG +/- buttons when recording TV programmes; select "L1" or "L2" with the INPUT SELECT button when recording from other equipment.
Timer recording	The timer does not operate.	<ul style="list-style-type: none"> Check that the clock is set. Make sure a tape has been inserted. Check that the safety tab has not been removed. Make sure the tape is not at its end. Make sure a programme has been set for timer recording. Make sure your timer settings have not already passed the current time. Check that the satellite tuner is turned on. The clock stops if the VCR is disconnected from the mains for more than an hour. Reset the clock and timer.

Symptom	Remedy
A tape cannot be inserted.	<ul style="list-style-type: none"> • Check that a tape isn't already in the tape compartment.
The remote commander does not function.	<ul style="list-style-type: none"> • Make sure you are pointing the remote commander at the remote sensor on the VCR. • Replace all the batteries in the remote commander with new ones if they are weak. • Make sure the [TV]/[VIDEO] remote control switch is set correctly.
The tracking indicator does not appear on the screen.	<ul style="list-style-type: none"> • The recording condition of the tape is very poor and tracking cannot be adjusted, or the NTSC system is being used.
The VCR needs to be cleaned.	<ul style="list-style-type: none"> • Clean the cabinet, panel and controls with a dry, soft cloth, or a soft cloth slightly moistened with a mild detergent solution. Do not use any type of solvent, such as alcohol or benzine.

Others

Specifications

System

Channel coverage

VHF R1 to R12, E2 to E12, NZ1 to NZ11

UHF E21 to E69, R21 to R60

CATV S01 to S05, S1 to S41

RF output signal

UHF channels 21 to 69

Aerial out

75-ohm asymmetrical aerial socket

Inputs and outputs

LINE-1 IN and LINE 2 IN

VIDEO IN, phono jack (1 each)

Input signal: 1 Vp-p, 75 ohms, unbalanced,
sync negative

AUDIO IN, phono jack (2 each)

Input level: 327 mVrms

Input impedance: more than 47 kilohms

LINE-1 OUT

VIDEO OUT, phono jack (1 each)

Output signal: 1 Vp-p, 75 ohms, unbalanced,
sync negative

AUDIO OUT, phono jack (2 each)

Standard output: 327 mVrms

Load impedance: 47 kilohms

Output impedance: less than 10 kilohms

General

Power requirements

110 – 240 V AC, 50/60 Hz

Power consumption

27W

Operating temperature

5°C to 40°C

Storage temperature

-20°C to 60°C

Dimensions

Approx. 430 × 100 × 282 mm (w/h/d)

including projecting parts and controls

Mass

Approx. 4.7 kg

Supplied accessories

Remote commander (1)

R6 (size AA) batteries (2)

Aerial cable (1)

Audio/video cable (1)

Design and specifications are subject to change
without notice.

Index to parts and controls

Refer to the pages indicated in parentheses () for details.

Front panel

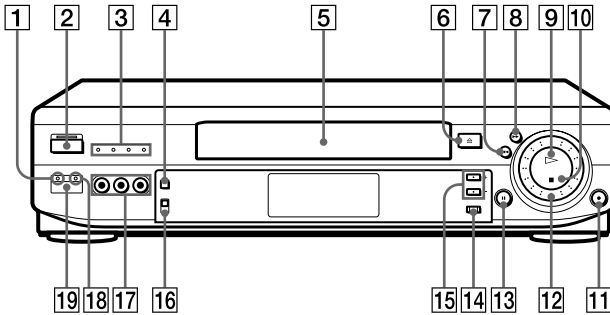

- | | |
|---|---|
| 1 EASY SET UP button (14) | 11 ● REC button (45, 64) |
| 2 ON/STANDBY switch/indicator (11) | 12 CLICK SHUTTLE ring (54) |
| 3 Multi system indicators (22) | 13 ■ PAUSE button (41, 64) |
| 4 INPUT SELECT button (51) | 14 QUICK TIMER button (55) |
| 5 Tape compartment | 15 PROGRAM/TRACKING +/- buttons (45, 61) |
| 6 ▲ EJECT button (41) | 16 COLOR SYSTEM switch (40) |
| 7 ◀◀ REW button (41, 53) | 17 LINE 2 IN VIDEO/AUDIO L/R jacks (63) |
| 8 ▶▶ FF button (41, 53) | 18 RF CH SET button (11) |
| 9 ▷ PLAY button (40) | 19 Remote sensor (5) |
| 10 ■ STOP button (41, 45) | |

continued

Index to parts and controls (continued)

Display window

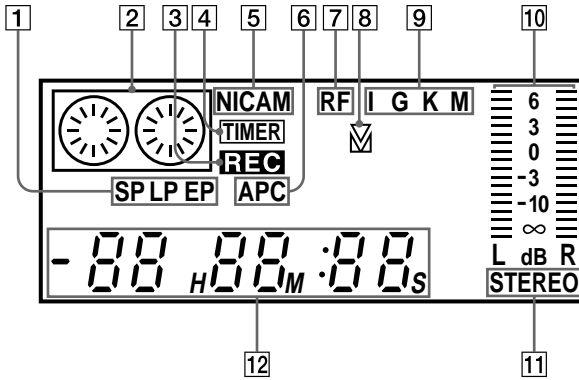

- | | | | |
|---|---------------------------|----|---|
| 1 | Tape speed indicator (45) | 8 | ☒ (Tracking) indicator (61) |
| 2 | Tape indicator | 9 | TV system indicator (12)
I/G/K/M |
| 3 | REC indicator | 10 | Audio channel/sound level
indicator (58) |
| 4 | TIMER indicator (48, 51) | 11 | STEREO indicator (57) |
| 5 | NICAM indicator (57) | 12 | Time counter/clock/line/
programme position (42, 45) |
| 6 | APC indicator (61) | | |
| 7 | RF indicator (11) | | |

Rear panel

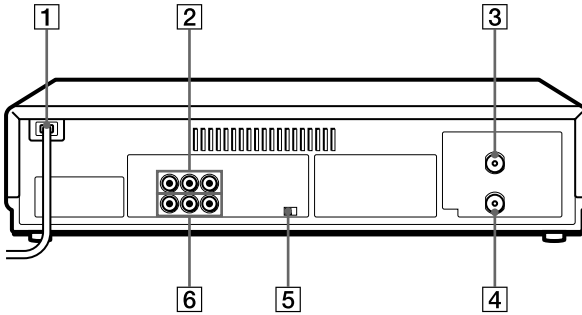

- | | |
|---|---|
| 1 Mains lead (8) | 4 AERIAL IN connector (8) |
| 2 LINE-1 IN AUDIO L/R/VIDEO jacks (63) | 5 NTSC PB switch (41) |
| 3 AERIAL OUT connector (8) | 6 LINE-1 OUT AUDIO L/R/VIDEO jacks (9) |

continued

Index to parts and controls (continued)

Remote commander

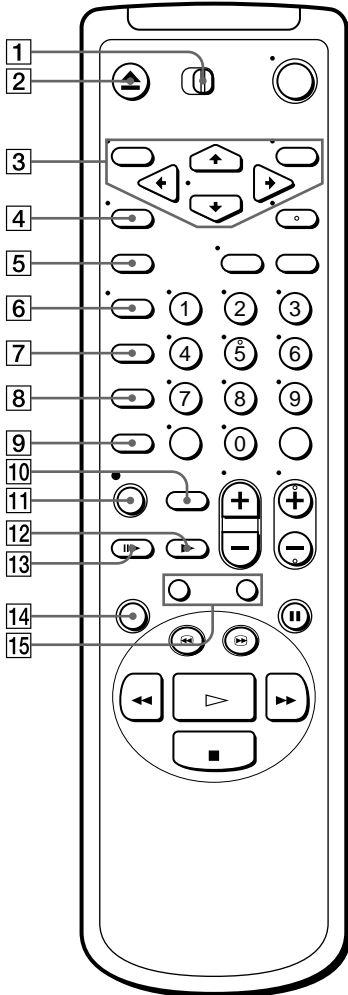

- 1** [TV]/[VIDEO] remote control switch (5)
- 2** ▲ EJECT button (41)
- 3** Menu buttons (14)
MENU button
CURSOR ↑/↓/←/→ buttons
EXECUTE button
- 4** WIDE button (6)
- 5** TRINITRON TV SYNCHRO PLAY button (43)
- 6** DISPLAY button (45)
- 7** COUNTER RESET button (42)
- 8** TIMER CLEAR button (48, 56)
- 9** QUICK TIMER button (55)
- 10** TAPE SPEED button (45)
- 11** ● REC button (45)
- 12** ►► SLOW button (53)
- 13** ||► FRAME button (53)
- 14** REPLAY buttons (41)
- 15** ◀◀/▶▶ INDEX SEARCH buttons (60)

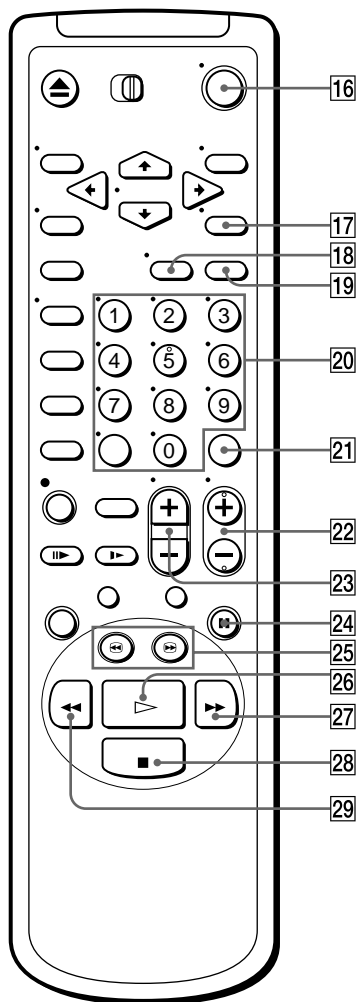

- 16 (on/standby) switch (14)
- 17 AUDIO MONITOR button (57)
- 18 TV/VIDEO button (*for TV*) (6)
- 19 G-CODE button (47)
- 20 Programme number /-/-- (ten's digit) buttons (46, 48)
- 21 SET button (48)
- 22 PROG +/- buttons (20, 45)
- 23 VOL +/- buttons (*for TV*) (6)
- 24 PAUSE button (41)
- 25 / SEARCH buttons (53)
- 26 PLAY button (40)
- 27 FF button (41, 53)
- 28 STOP button (41)
- 29 REW button (41, 53)

Index

A, B

- Accessories supplied 4
- Adjusting
 - picture 23, 54, 61
 - tracking 54, 61
- Aerial hookup 8
- AFT (Auto Fine Tuning) 23
- APC (Adaptive Picture Control) 61
- Audio track 59
- AV connection 9

C

- Cancelling timer settings 56
- Changing timer settings 56
- Cleaning the video heads 65
- Clock setting 38
- Colour system
 - compatible colour systems 2
 - setting 41
- Connecting
 - to a stereo system 9
 - to a TV with an aerial cable 8
 - to a TV with audio/video jacks 9
- Counter 42

D

- Disabling programme position 22, 37
- Dubbing. *See* Editing

E, F

- EASY SET UP 14
- Editing 63
- EP mode 45

G

- G-CODE
 - recording 47
 - setting 32
- Guide channel setting up 32

H

- Hi-fi audio track 59

I, J, K

- Index searching 60

L

- Language selecting 17
- LP mode 45

M

- Monitoring
 - during playback 58
 - during recording 57

N, O

- NICAM broadcasts 57
- Normal audio track 59
- NTSC-recorded tapes 41

P

- Picture adjustment. *See* Adjusting
- Playback 40
 - at various speeds 53
 - slow motion 53
- Presetting channels 18

Q

- Quick timer 55

R

- Recording 44
 - bilingual programmes 57
 - saving 46
 - stereo programmes 57
 - using G-CODE 47
 - while watching another programme 46
- Remote commander 5

S

- Safety tab 46
- Searching
 - at various speeds 53
 - using the index function 60
- SP mode 45

T, U, V, W, X, Y

- Timer recording 50
 - cancelling timer settings 56
 - changing timer settings 56
 - checking timer settings 56
 - daily/weekly recording 51
 - overlapping timer recordings 56
 - using G-CODE 47
- Tracking adjustment. *See* Adjusting
- Trinitron TV Synchro Play 43

Z

- ZWEITON broadcasts 57