

Color Rear Video Projector

Operating Instructions

IMPORTANT SAFETY INFORMATION:

Please read the important safety information on the inside cover.

CONSIGNES DE SECURITE IMPORTANTES:

Lisez les instructions de sécurité importantes sur la couverture intérieure.

KP-53XBR200

KP-61XBR200

© 1998 by Sony Corporation

If, after reading the following instructions, you have additional questions related to the use of your Sony projection TV, please call one of the following numbers (English only).

Customers in the continental United States contact the Direct Response Center at:

1-800-222-SONY (7669)

Customers in Canada contact the

Customer Relations Center at:

(416) 499-SONY (7669)

Table of Contents

<i>Welcome!</i>	1
<i>Precautions</i>	1
<i>Using This Manual</i>	2

Installing and Connecting the Projection TV

Carrying your projection TV	2
Installing the Projection TV	2
Mounting the Supplied Rear Speakers	3
Connector Types	4
Making Connections	4
Connecting directly to cable or an antenna	4
Cable or antenna	5
Cable and antenna	5
Connecting a cable box	5
Cable box and cable	5
Connecting an antenna/cable TV system with a VCR	6
Connecting to an S Video equipped VCR	7
Connecting a VCR and projection TV with a cable box	8
Connecting to an S Video equipped VCR with a cable box	9
Connecting a DBS receiver	10
Connecting a DBS receiver and a VCR	11
Connecting a camcorder	12
Connecting two VCRs for tape editing	13

Connecting a DVD Player without component video output connectors	14
Connecting a DVD Player with component video output connectors	15
Connecting an AV receiver	16
Connecting an audio system	17
Connecting an amplifier with Dolby Pro Logic decoder	18
Using the S-Link/CONTROL S function	19

Basic Set Up

Inserting Batteries	22
Using the Remote Control Joystick	22
Adjusting Sliders	22
On Line Help/Instructions	22

Using your New projection TV

Setting Up the Projection TV Automatically	23
Adjusting the Convergence Automatically (AUTO FOCUS)	24
Watching the TV	25
Watching Two programs at One Time — PIP	28
Watching Two Programs at One Time — P&P (Twin View™)	30
Using CHANNEL INDEX	32

Adjusting Your SET UP (menus)

Learning Menu Selection	34
Using the VIDEO Menu	35
Using ADVANCED VIDEO Menu	37
Using the AUDIO Menu	38
Adjusting the Speaker Volume for Customized Surround Mode	40
Using the TIMER Menu	41
Using the CHANNEL SET UP Menu	43
Setting and Selecting FAVORITE CHANNEL	46
Using the SET UP Menu	48

Operating Video Equipment

Setting the Manufacturer's Code	52
---------------------------------------	----

Operating a Cable Box or DBS Receiver

Setting the Manufacturer's Code	54
---------------------------------------	----

Troubleshooting

Specifications

Index

Owner's Record

The model and serial numbers are located at the rear of the TV, below the Sony logo, on the sticker, and also on the TV box (white label). Record these numbers in the spaces provided below. Refer to them whenever you call upon your Sony dealer regarding this product.

Model No.	KP- _____
Serial No.	_____

Welcome!

Thank you for purchasing the Sony Color Rear Video Projection TV. This manual is for models, KP-53XBR200 and KP-61XBR200.

Model KP-53XBR200 is used for illustration purposes.

The features you will enjoy include:

- DRC (Digital Reality Creation), a technology unique to Sony, allowing you to obtain a finer, more detailed picture with four-times higher-density than the conventional NTSC picture.
- MID (Multi Image Driver), a newly developed device, allowing you to enjoy the following features and, at the same time, to use your projection TV easily.
 - Picture & Picture (P&P) with zoom-in function (Twin View™)
 - Picture-in-Picture (PIP)
 - CHANNEL INDEX, allowing you to view and choose from twelve programs
 - FAVORITE CHANNEL, allowing you to view and choose from eight of your favorite channels
- AUTO FOCUS, allowing you to adjust convergence automatically.
- S-Link™, allowing you to synchronize some operations of your projection TV with those of other Sony components.
- One Y/C_B/C_R input for DVD Player connection.
- Five AUDIO/VIDEO/S VIDEO inputs.

Precautions

Safety

- Operate the projection TV only on 120 V AC.
- The plug is designed, for safety purposes, to fit into the wall outlet only one way. If you are unable to insert the plug fully into the outlet, contact your dealer.
- If any liquid or solid object should fall inside the cabinet, unplug the projection TV immediately and have it checked by qualified service personnel before operating it further.
- If you will not be using the projection TV for several days, disconnect the power by pulling the plug itself. Never pull on the cord.

For details concerning safety precautions, see the supplied leaflet "IMPORTANT SAFEGUARDS."

Note on cleaning

Clean the cabinet of the projection TV with a dry soft cloth. To remove dust from the screen, wipe it gently with a soft cloth. Stubborn stains may be removed with a cloth slightly dampened with solution of mild soap and warm water. Never use strong solvents such as thinner or benzine for cleaning.

If the picture becomes dark after using the projection TV for a long period of time, it may be necessary to clean the inside of the projection TV. Consult qualified service personnel.

Installing

- To prevent internal heat buildup, do not block the ventilation openings.
- Do not install the projection TV in a hot or humid place, or in a place subject to excessive dust or mechanical vibration.
- If the projection TV is transported directly from a cold to a warm location, or if the room temperature has changed suddenly, the picture may be blurred or show poor color. In this case, let the moisture evaporate before using the projection TV.
- To obtain the best picture, do not expose the screen to direct illumination or direct sunlight. It is recommended to use spot lighting directed down from the ceiling or to cover the windows that face the screen with opaque drapery. It is desirable to install the projection TV in a room where the floor and walls are not of reflecting material.

Using This Manual

This manual is divided into four major sections. We recommend that you carefully review the contents of each section in the order provided to ensure that you fully understand the operation of your new projection TV.

1 Installing and Connecting the Projection TV.

This section will guide you through your initial set up. It will show you how to connect your new components and how to connect to your antenna or cable.

2 Basic Set Up.

This section will teach you the basic skills needed to operate your new projection TV. It will show you how to operate special functions of the remote control.

3 Using Your New Projection TV.

This section will show you how to begin using your new projection TV. It will show you how to use the AUTO SET UP feature, and how to use your remote control's features.

4 Adjusting Your Set Up (menus).

This section will teach you how to access on-screen menus and adjust your projection TV's settings.

Instructions in this manual are written for the remote control. Similar controls may be found on the projection TV console.

Installing and Connecting the Projection TV

Carrying your projection TV

Carrying the projection TV requires three or more people. The projection TV has been equipped with casters for easy movement. Please move your projection TV using the casters.

Installing the Projection TV

Recommended viewing area (Horizontal)

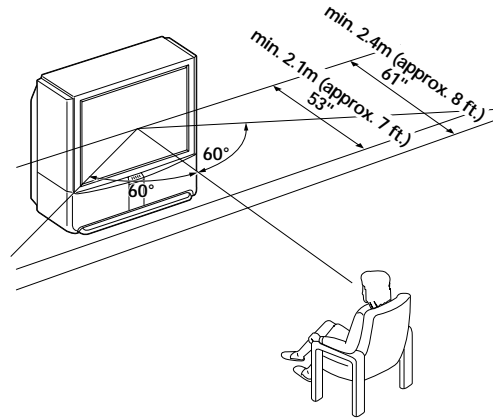

Recommended viewing area (Vertical)

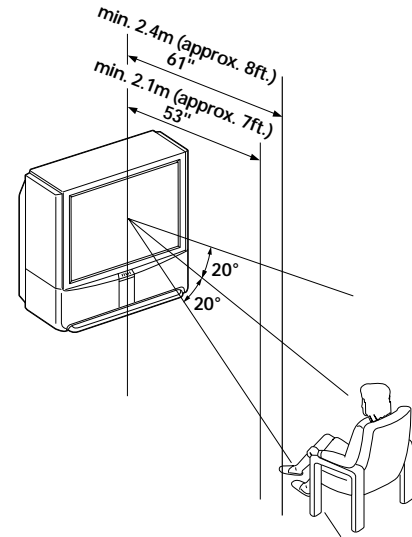

Mounting the Supplied Rear Speakers

For enhanced surround effect, connect the supplied rear speakers to your projection TV.

Connecting the rear speakers

Using the supplied speaker cord, connect REAR SPEAKER OUT L on your projection TV to the speaker terminal on one rear speaker, and connect REAR SPEAKER OUT R to the terminal on the other one.

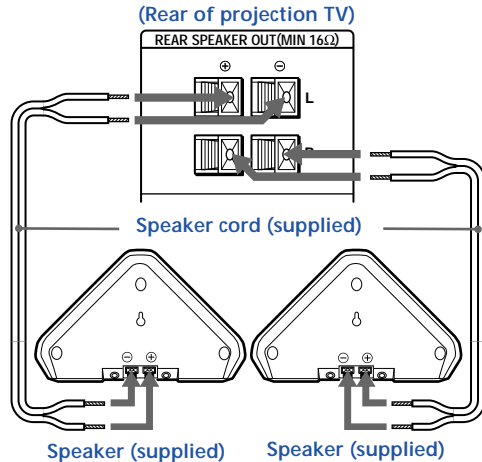

Installation

For optimum surround effect, mount the rear speakers in the following places (as shown in the illustration):

- on a wall, a little higher or lower than the listener's ears.
- on a table, a little lower than the listener's ears.
- on a corner of wall and ceiling.

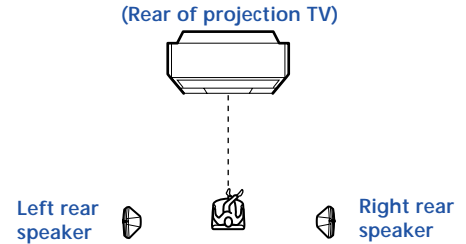
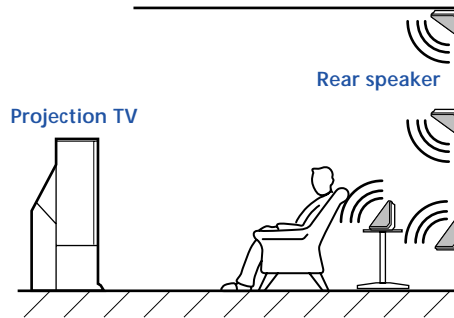

Note:

- Match the colors of the speaker cords and the terminals. If the colors are reversed, sound will be distorted.

Installing and Connecting the Projection TV (continued)

Connector Types

You may find it necessary to use some of the following connector types during set up.

Coaxial cable

Standard TV cable and antenna connector

Plug Type



Screw-on Type



S Video cable

High quality video connector for enhanced picture quality

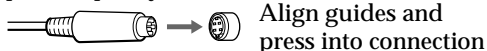

Audio/Video cable



Video - Yellow

Audio (Left) - White

Audio (Right) - Red

(Some DVD Players are equipped with the following three video connectors.)

Y - Green

C_B (C_b, B-Y or P_B) - Blue

C_R (C_r, R-Y or P_R) - Red

S-Link/CONTROL S cable

Sony connector for S-Link and CONTROL S connections. These features are exclusive to Sony products and allow greater control of all Sony equipment.



Note:

- For S-Link and CONTROL S connections, you can use the combined S-Link/CONTROL S cable provided with some Sony video equipment, or you can purchase a separate S-Link/CONTROL S cable (RK-G69HG).

Making Connections

For the best picture quality, a cable TV system or outdoor antenna is recommended.

Connecting directly to cable or an antenna

The connection you choose will depend on the cable found in your home. Newer homes will be equipped with standard coaxial cable (see **A**); older homes will probably have 300-ohm twin lead cable (see **B**); still other homes may contain both (see **C**).

A

- VHF only
or
- VHF/UHF
or
- Cable

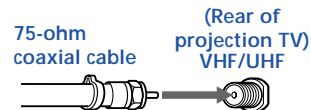

B

- VHF only
or
- UHF only
or
- VHF/UHF

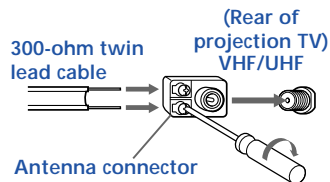

C

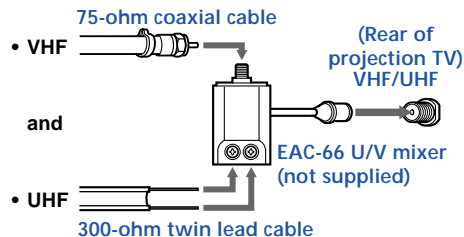
- VHF
 - and
 - UHF
- 

Cable or antenna

Most simple connection. Connection is made directly from the cable or antenna to the projection TV.

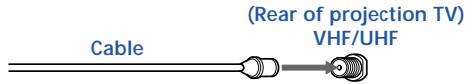

Cable and antenna

You may find it convenient to use the following set up if your cable provider does not feature local channels that you are able to receive using an antenna.

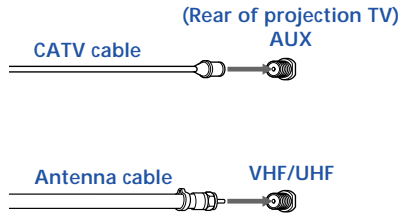

Select Cable or ANT mode by pressing ANT on the remote control.

Connecting a cable box

Some pay cable TV systems use scrambled or encoded signals that require a cable box* to view all channels.

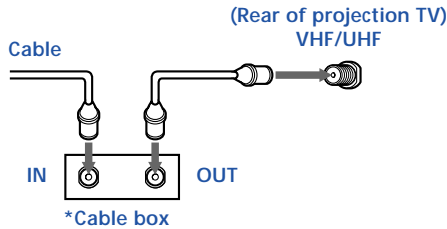

Note:

- If you will be controlling all channel selection through your cable box, you should consider using the CHANNEL FIX feature. (see "CHANNEL FIX" on page 45)

Cable box and cable

Some pay cable TV systems use scrambled or encoded signals requiring a cable box* only for certain channels (e.g. HBO, SHOWTIME, etc.).

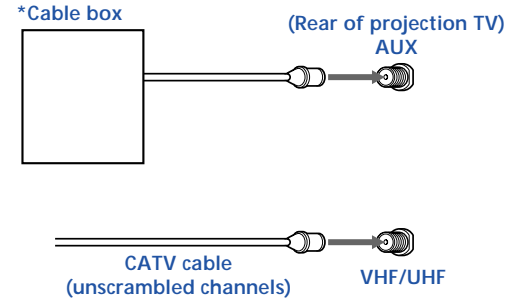

For this set up, you can switch between scrambled channels (through your cable box), and normal (CATV) channels by pressing ANT on your remote control.

Notes:

- You may be able to program your Sony remote control to operate your cable box. (see "Operating a Cable Box or DBS Receiver" on page 54)
- During PIP, P&P, CHANNEL INDEX or FAVORITE CHANNEL viewing, the AUX input can only be viewed in the main picture.
- If you are connecting a cable box through the AUX input and would like to switch between the AUX and normal (CATV) input you should consider using CHANNEL FIX. (see "CHANNEL FIX" on page 45)

Installing and Connecting the Projection TV (continued)

Disconnect all power sources before making any connections.

Connecting an antenna/cable TV system with a VCR

- 1 Attach the coaxial connector from your cable or antenna to IN on your VCR.
- 2 Using AUDIO/VIDEO connectors, connect AUDIO and VIDEO OUT on your VCR to AUDIO and VIDEO IN on your projection TV (Yellow-VIDEO, White-AUDIO Left, Red-AUDIO Right).
- 3 Using a coaxial connector, connect OUT on your VCR to VHF/UHF on your projection TV.

Note:

- If you are connecting a monaural VCR, connect only the single audio output to the left (MONO) input on your projection TV.

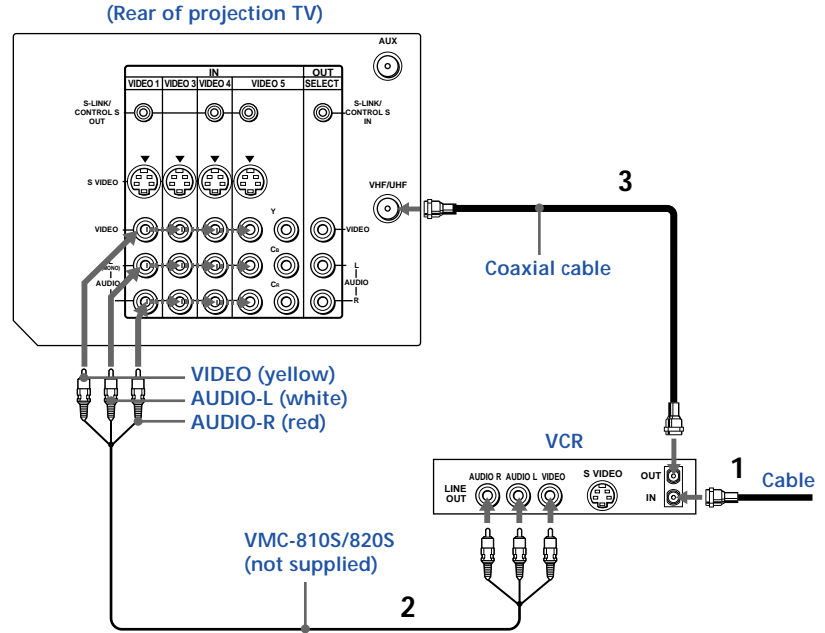

Connecting to an S Video equipped VCR

- 1 Attach the coaxial connector from your cable or antenna to IN on your VCR.
- 2 Using AUDIO connectors, connect AUDIO OUT on your VCR to AUDIO IN on your projection TV (White-AUDIO Left, Red-AUDIO Right).
- 3 Using a coaxial connector, connect OUT on your VCR to VHF/UHF on your projection TV.
- 4 Using an S VIDEO connector, connect S VIDEO on your VCR to S VIDEO on your projection TV.

Note:

- If you are connecting a monaural VCR, connect only the single audio output to the left (MONO) input on your projection TV.

Disconnect all power sources before making any connections.

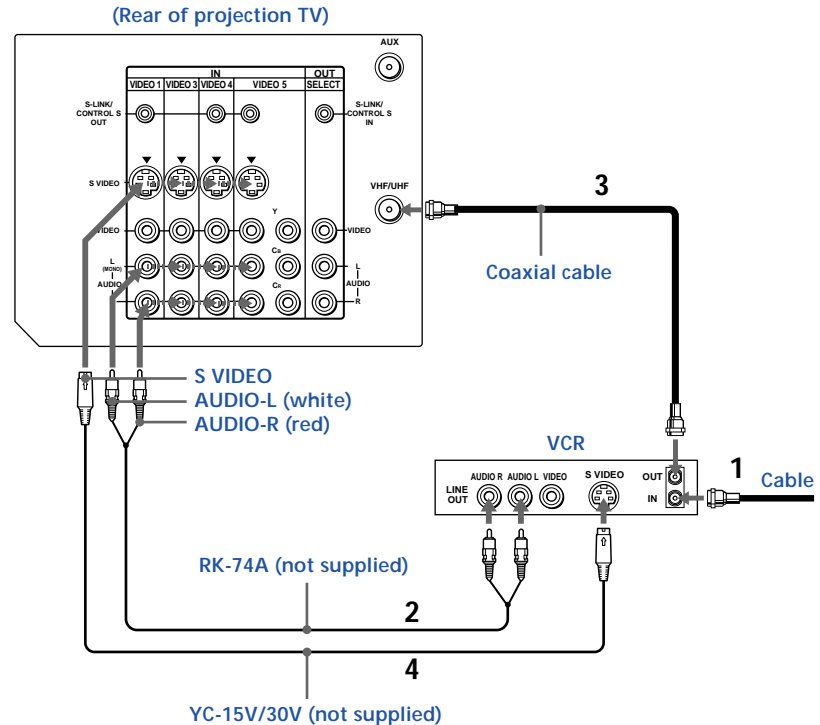

Installing and Connecting the Projection TV (continued)

Disconnect all power sources before making any connections.

Connecting a VCR and projection TV with a cable box

- 1 Connect the single (input) jack of the Splitter to your incoming cable connection, and connect the other two (output) jacks (using coaxial cable) to IN on your cable box and VHF/UHF on your projection TV.
- 2 Using a coaxial connector, connect OUT on your cable box to IN on your VCR.
- 3 Using AUDIO/VIDEO connectors, connect AUDIO and VIDEO OUT on your VCR to AUDIO and VIDEO IN on your projection TV (Yellow-VIDEO, White-AUDIO Left, Red-AUDIO Right).

Note:

- To view scrambled channels through your cable box, select the video input which your cable box is connected to by pressing TV/VIDEO.

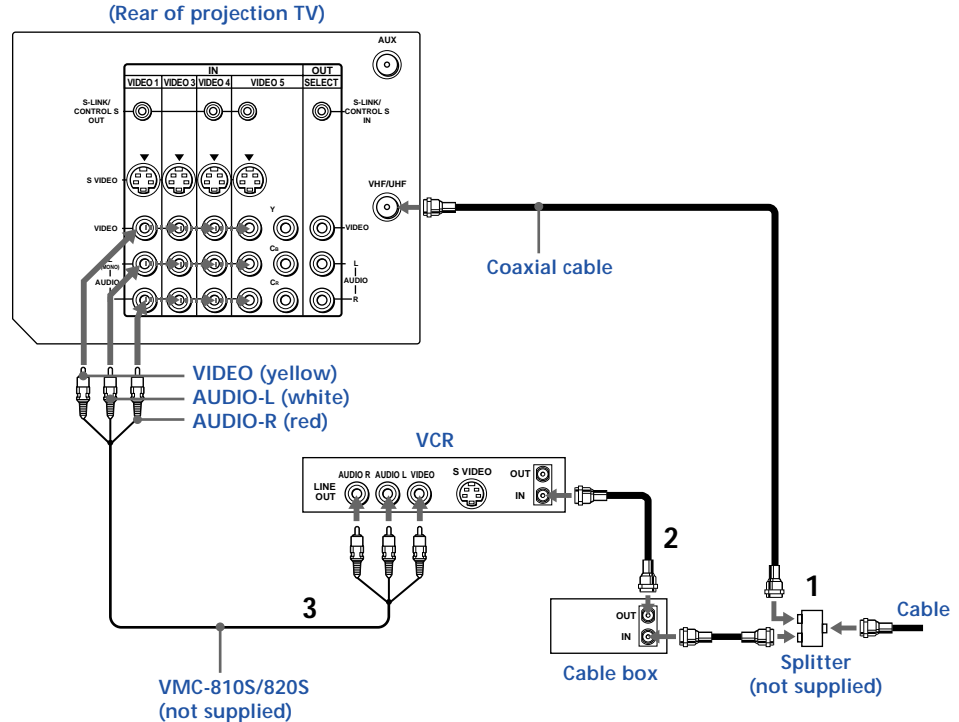

Connecting to an S Video equipped VCR with a cable box

1-2 Perform as described on page 8.

3 Using AUDIO connectors, connect AUDIO OUT on your VCR to AUDIO IN on your projection TV (White-AUDIO Left, Red-AUDIO Right).

4 Using an S VIDEO connector, connect S VIDEO on your VCR to S VIDEO on your projection TV.

Note:

- To view scrambled channels through your cable box, select the video input which your cable box is connected to by pressing TV/VIDEO.

Disconnect all power sources before making any connections.

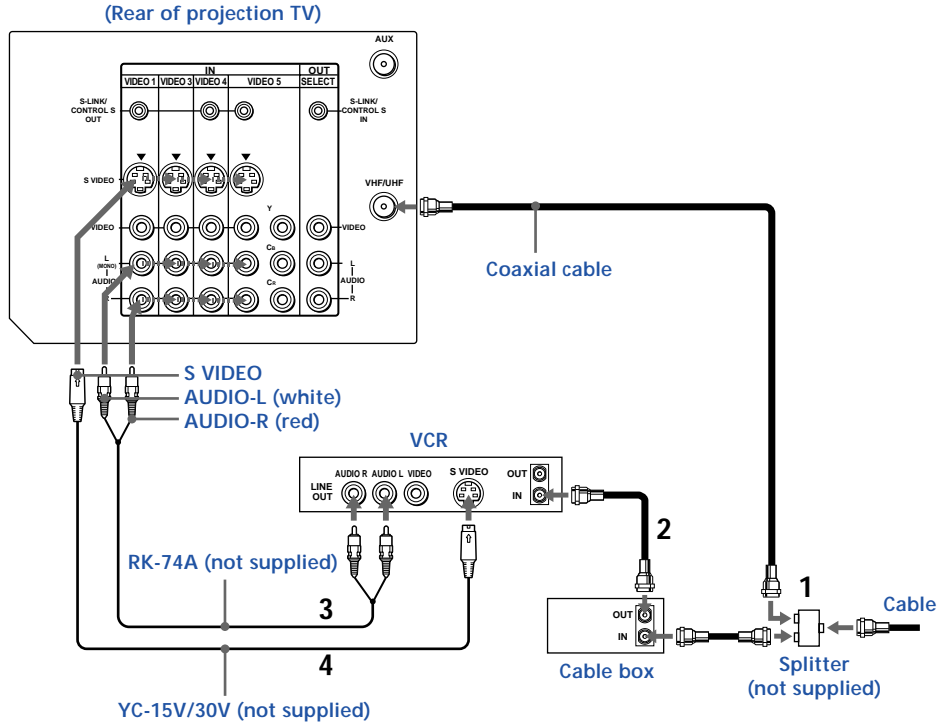

Installing and Connecting the Projection TV (continued)

Disconnect all power sources before making any connections.

Connecting a DBS (Direct Broadcast Satellite) receiver

- 1 Connect the cable from your satellite antenna to your DBS receiver.
- 2 Attach the coaxial connector from your cable or antenna to VHF/UHF on your projection TV.
- 3 Using AUDIO connectors, connect AUDIO OUT on your DBS receiver to AUDIO IN on your projection TV (White-AUDIO Left, Red-AUDIO Right).
- 4 Using an S VIDEO connector, connect S VIDEO on your DBS receiver to S VIDEO on your projection TV.

Note:

- To view input from the DBS, select the video input which your DBS receiver is connected to by pressing TV/VIDEO on the remote control.

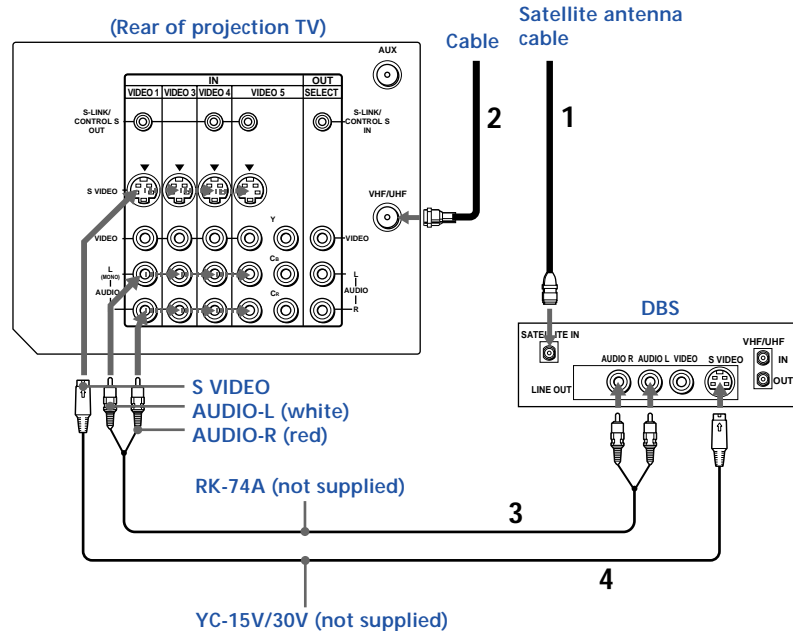

Connecting a DBS (Direct Broadcast Satellite) receiver and a VCR

- 1 Connect the cable from your satellite antenna to your DBS receiver.
- 2 Attach the coaxial connector from your cable or antenna to VHF/UHF IN on your VCR.
- 3 Using a coaxial connector, connect VHF/UHF OUT on your VCR to VHF/UHF IN on your projection TV.
- 4 Using AUDIO and S VIDEO connectors, connect AUDIO OUT and S VIDEO on your DBS receiver to AUDIO IN and S VIDEO on your VCR.
- 5 Using AUDIO and S VIDEO connectors, connect AUDIO OUT and S VIDEO on your VCR to AUDIO IN and S VIDEO on your projection TV (White-AUDIO Left, Red-AUDIO Right).

Notes:

- To view input from the DBS or VCR, select the video input which your DBS receiver or VCR is connected to by pressing TV/VIDEO on the remote control.
- If your VCR is not equipped with S VIDEO, connect VIDEO OUT on your VCR to VIDEO IN on your projection TV using AUDIO/VIDEO connectors.

Disconnect all power sources before making any connections.

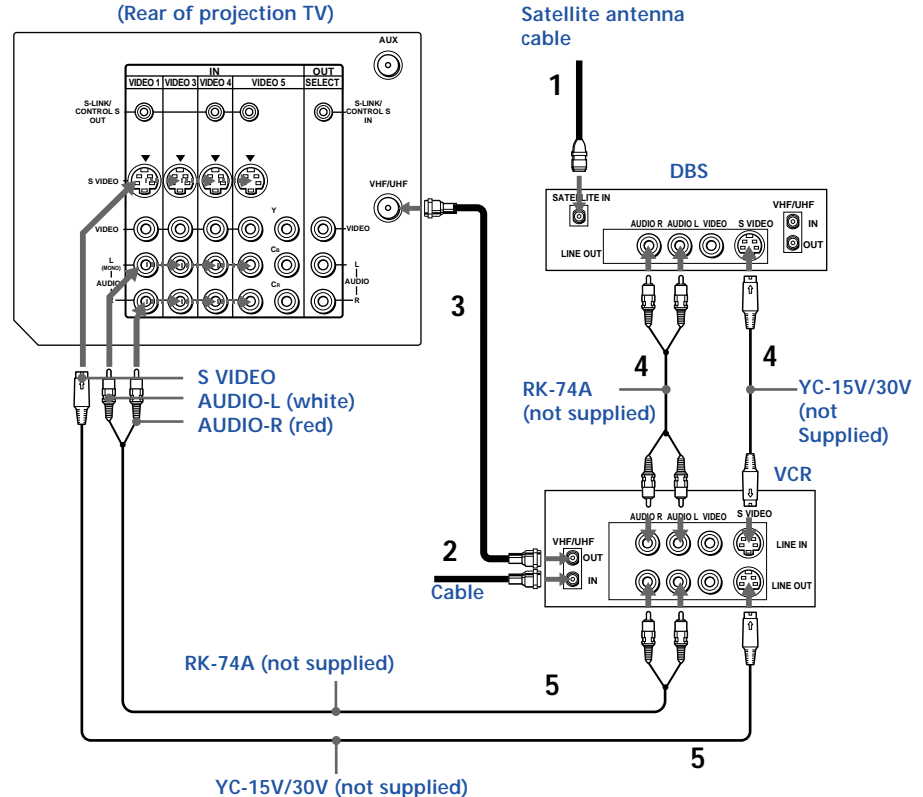

Installing and Connecting the Projection TV (continued)

Disconnect all power sources before making any connections.

Connecting a camcorder

Use this connection to view a picture directly from your camcorder.

Using AUDIO/VIDEO connectors, connect AUDIO and VIDEO OUT on your camcorder to AUDIO and VIDEO IN on the front panel of your projection TV (Yellow-VIDEO, White-AUDIO Left, Red-AUDIO Right).

Notes:

- If you are connecting a monaural camcorder, connect only the single audio output to the left (MONO) input on your projection TV.
- If you have an S Video equipped camcorder, you can use an S Video connection.

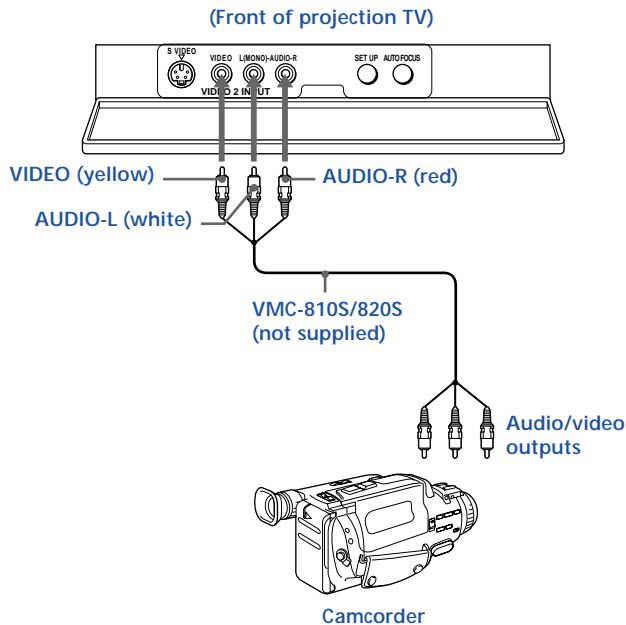

Connecting two VCRs for tape editing

SELECT OUT gives you the ability to use a second VCR to record a program being played by the primary VCR or to perform tape editing and dubbing.

- 1 Connect the VCR intended for playback using the connection instructions on pages 6 and 7 of this manual.
- 2 Using AUDIO/VIDEO connectors, connect AUDIO and VIDEO IN on your VCR intended for recording to SELECT OUT AUDIO and VIDEO on your projection TV.

Notes:

- Do not change the input signal while editing through SELECT OUT.
- When connecting a single VCR to the projection TV: if VCR LINE OUT is connected to projection TV's VIDEO IN, **do not** connect the projection TV's SELECT OUT jacks to the VCR LINE INPUT (see right). Doing so will cause program interference and other viewing problems.
- You can select the output signal from SELECT OUT from the SET UP menu. (see "SELECT OUT" on page 48)

Disconnect all power sources before making any connections.

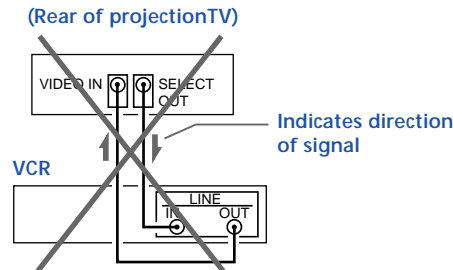
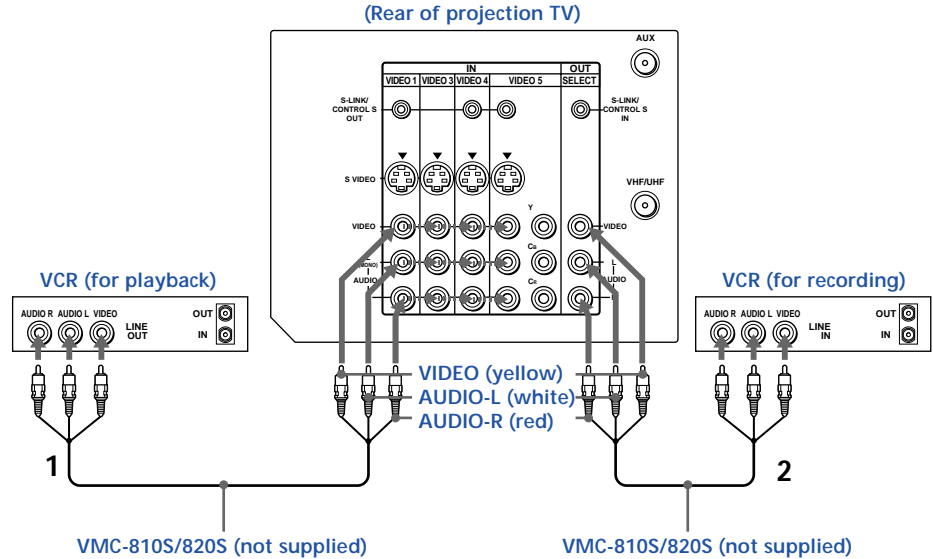

Installing and Connecting the Projection TV (continued)

Disconnect all power sources before making any connections.

Connecting a DVD Player without component video output connectors

Using AUDIO/VIDEO connectors, connect AUDIO and VIDEO IN on your projection TV to LINE OUT on your DVD Player.

Note:

- Since the high quality pictures on a DVD disc contain a lot of information, picture noise may appear. In this case, adjust NR in the ADVANCED VIDEO menu. (see “NR” on page 37)

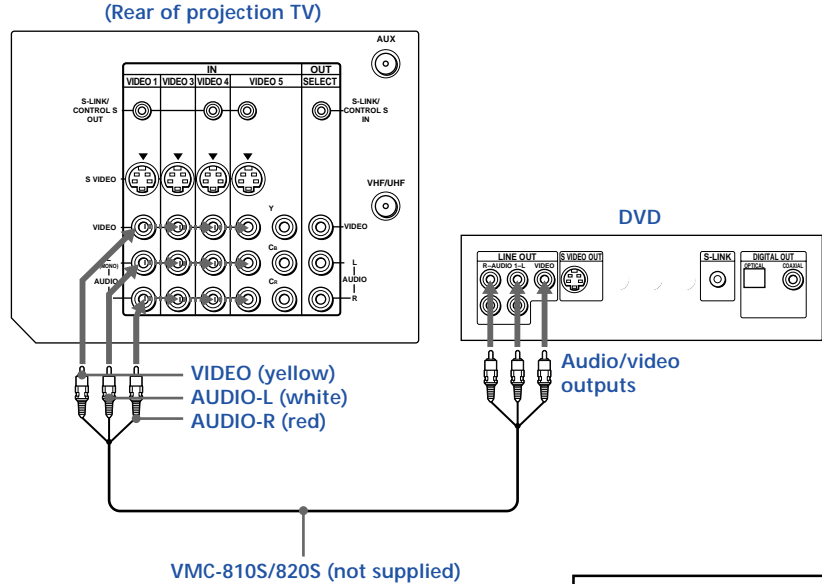

Connect your DVD Player directly to your projection TV. Connecting the DVD Player through other video equipment will cause unwanted picture noise.

Connecting a DVD Player with component video output connectors

- Using AUDIO connectors, connect AUDIO R and L of the LINE OUT on your DVD Player to AUDIO R and L on the VIDEO 5 IN panel at the rear of your projection TV.
- Using three yellow VIDEO connectors, connect Y, C_B, and C_R on the COMPONENT VIDEO OUT on your DVD Player to Y, C_B, and C_R on the VIDEO 5 IN panel at the rear of your projection TV.

Notes:

- Some DVD Player terminals may be labeled differently. If so, connect as follows:

Connect	To
Y (green)	Y
C _B (blue)	C _b , B-Y or P _B
C _R (red)	C _r , R-Y or P _R

- Since the high quality pictures on a DVD disc contain a lot of information, picture noise may appear. In this case, adjust NR in the ADVANCED VIDEO menu. (see "NR" on page 37)

Disconnect all power sources before making any connections.

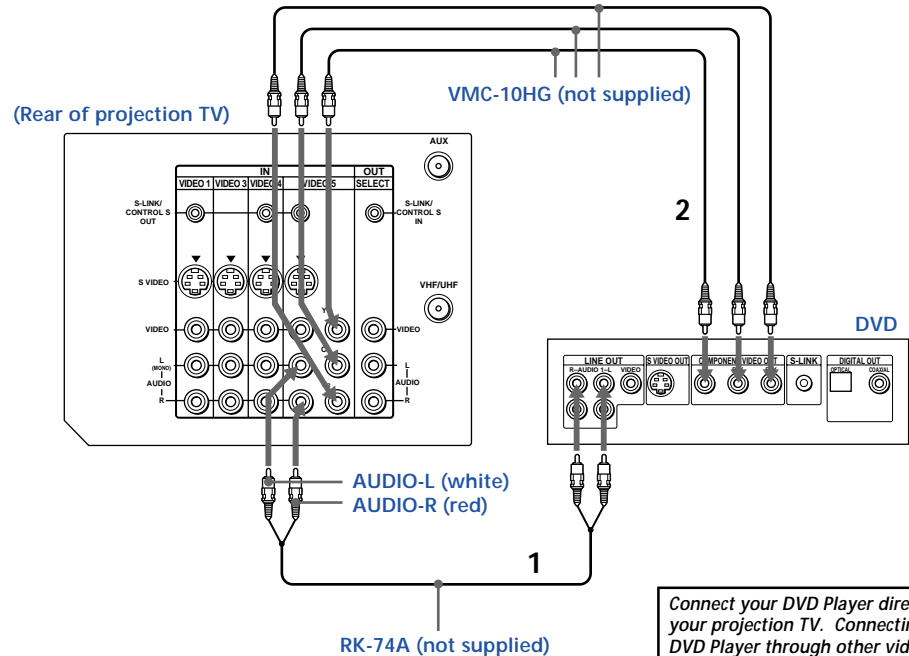

Connect your DVD Player directly to your projection TV. Connecting the DVD Player through other video equipment will cause unwanted picture noise.

Installing and Connecting the Projection TV (continued)

Disconnect all power sources before making any connections.

Connecting an AV receiver

For greater control of all audio and video equipment, connect your AV receiver.

- 1 Using AUDIO/VIDEO connectors, connect VIDEO 1 IN on your projection TV to Monitor AUDIO and VIDEO OUT on your AV receiver.
- 2 Using AUDIO/VIDEO connectors, connect SELECT OUT on your projection TV to TV AUDIO and VIDEO IN on your AV receiver.
- 3 Use the SET UP menu to set SELECT OUT to TV OUT. (see "SELECT OUT" on page 48)

Note:

- You may want to use CHANNEL FIX to fix your TV's input to the AV receiver (VIDEO 1). (see "CHANNEL FIX" on page 45)

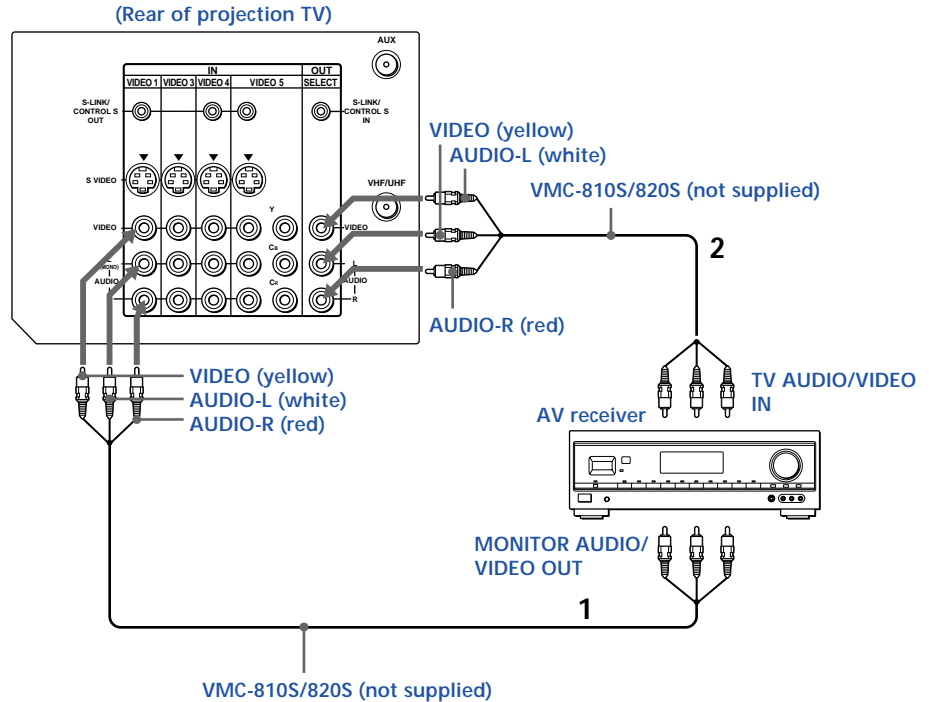

Disconnect all power sources before making any connections.

Connecting an audio system

For more dynamic sound, connect your audio system to your projection TV.

- 1 Using AUDIO connectors, connect AUDIO (VAR) OUT on your projection TV to one of the unused Line inputs (e.g. Tape-2, AUX1, etc.) on your stereo (White-AUDIO Left, Red-AUDIO Right).
- 2 Set your stereo to the chosen Line input and use the AUDIO menu to switch projection TV's speakers off. (see "SPEAKER" on page 38)

Note:

- You can adjust VOLUME, BASS, TREBLE and BALANCE through the projection TV on AUDIO (VAR) OUT only.

(Rear of projection TV)

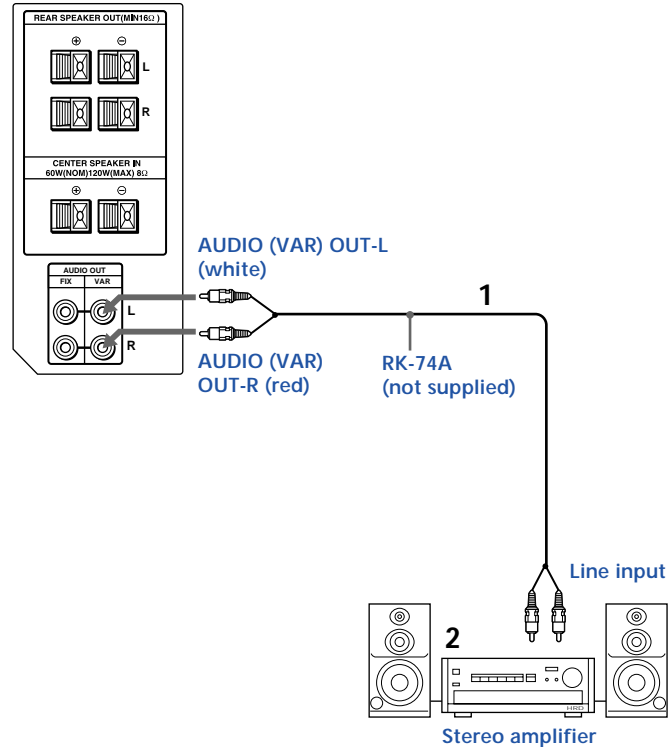

Installing and Connecting the Projection TV (continued)

Connecting an amplifier with Dolby Pro Logic decoder

If you use an amplifier with Dolby Pro Logic decoder instead of the projection TV's audio system, you can still use the projection TV's center speaker.

- 1 Using the speaker cords (supplied with the amplifier), connect the speaker terminals on your amplifier to CENTER SPEAKER IN +/- on your projection TV.
- 2 Using AUDIO/VIDEO connectors, connect AUDIO (FIX) OUT on your projection TV to one of the unused Line inputs (e.g. Tape-2, AUX1, etc.) on your amplifier (White-AUDIO Left, red-AUDIO Right).
- 3 Set your amplifier to the chosen Line input and use the AUDIO menu to set "SPEAKER" to "CENTER IN" on your projection TV. (see "SPEAKER" on page 38)

* Manufactured under license from Dolby Laboratories Licensing Corporation. Additionally licensed under Canadian patent number 1,037,877. "Dolby," the double-D symbol  and "Pro Logic" are trademarks of Dolby Laboratories Licensing Corporation.

Disconnect all power sources before making any connections.

(Rear of projection TV)

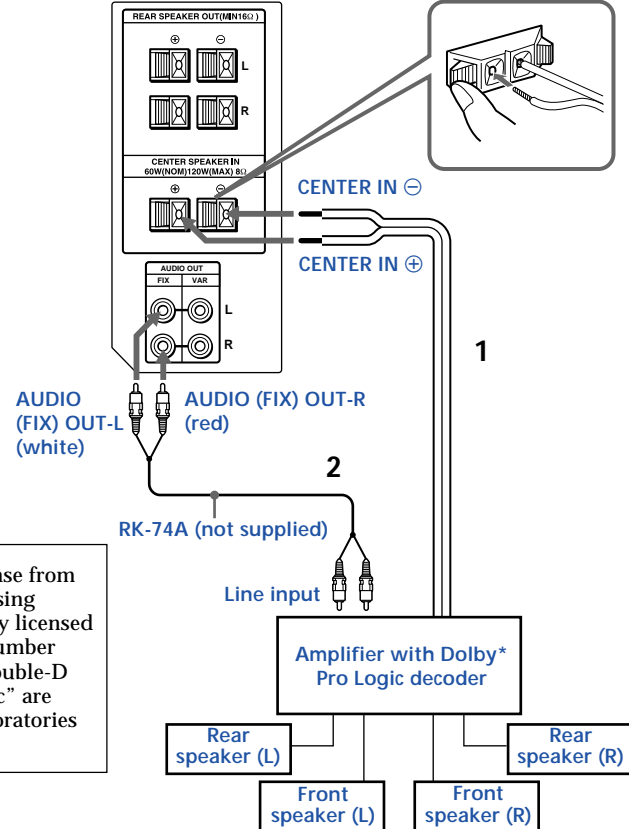

Using the S-Link/CONTROL S function

S-Link is a Sony innovation designed to make your Sony components work together. It allows you to automatically switch the projection TV's input mode to video when you press the play button on your Sony S-Link VCR. It also allows you to turn the VCR and projection TV off at the same time with the SYSTEM OFF button on the remote control.

Using the S-Link function without a Sony AV receiver

- 1 Connect your VCR. (see "Connecting an antenna/cable TV system with a VCR" or "Connecting to an S Video equipped VCR" on pages 6 and 7)
- 2 Using an S-LINK connector, connect the S-LINK jacks on your VCR (DVD) and projection TV. Ensure that both ends are seated firmly and that the projection TV's S-LINK jack is in the same row as the AUDIO/VIDEO connectors.

Refer also to the Operating Instructions supplied with your VCR, DBS tuner, DVD player, LD player and other Sony video equipment for details.

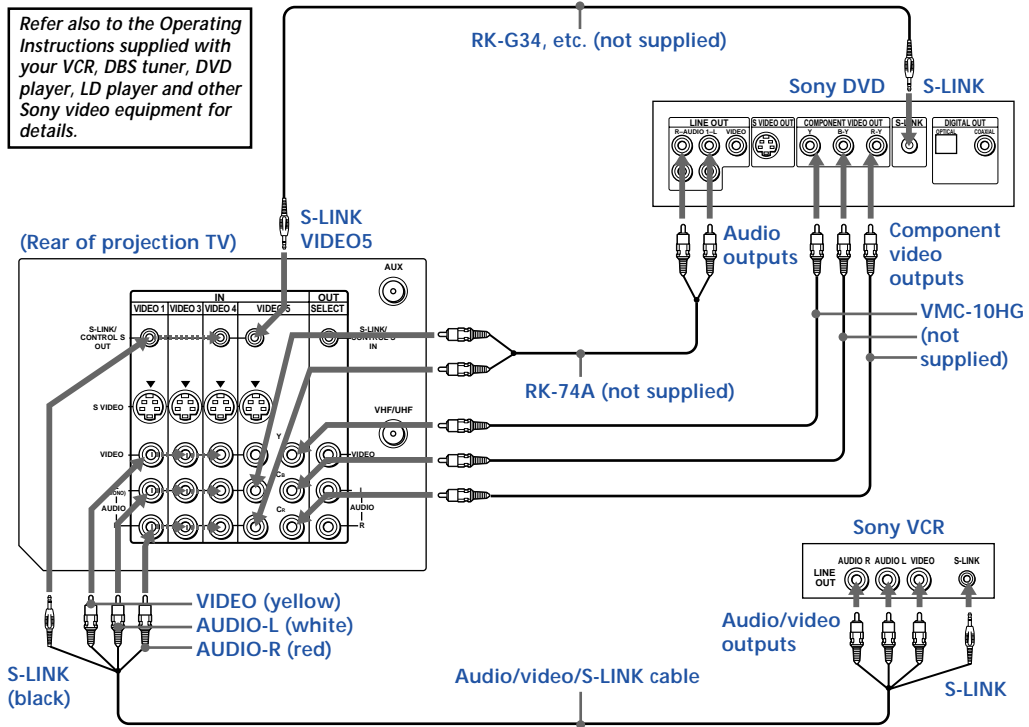

Disconnect all power sources before making any connections.

Installing and Connecting the Projection TV (continued)

Using the S-Link function with a Sony AV receiver

- 1 Using VIDEO connector, connect VIDEO 1 IN on your projection TV to MONITOR VIDEO OUT on your Sony AV receiver.
- 2 Using AUDIO/VIDEO connectors, connect SELECT OUT on your projection TV to TV AUDIO and VIDEO IN on your receiver.
- 3 Using an S-LINK connector, connect S-LINK on VIDEO 1 IN on your projection TV and S-LINK on MONITOR OUT on your AV receiver.
- 4 Using an S-LINK connector, connect projection TV's S-LINK on SELECT OUT to S-LINK on TV IN on your AV receiver.
- 5 Using AUDIO/VIDEO and S-LINK connectors, connect your Sony video equipment to your AV receiver.
- 6 Use the AUDIO menu to set SPEAKER to ALL OFF or CENTER IN. (see "SPEAKER" on page 38)
- 7 Use the SET UP menu to set SELECT OUT to TV OUT. (see "SELECT OUT" on page 48)

Disconnect all power sources before making any connections.

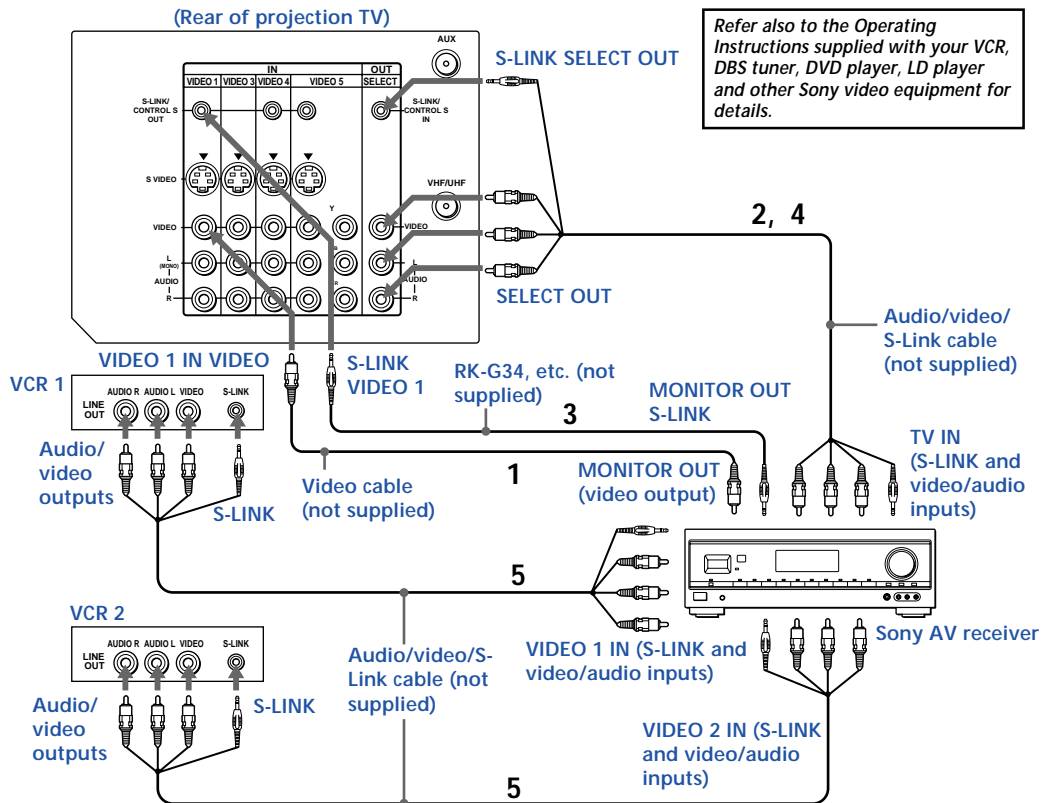

Using the CONTROL S feature

CONTROL S allows you to control your projection TV and other Sony equipment with one remote control.

To control other Sony equipment with your projection TV's remote control, connect the CONTROL S IN jack of the equipment to the CONTROL S OUT jack on the projection TV with the CONTROL S cable.

To control your projection TV with other Sony equipment's remote control, connect the CONTROL S OUT jack of the equipment to the CONTROL S IN jack on the projection TV with the CONTROL S cable.

Disconnect all power sources before making any connections.

(Rear of projection TV)

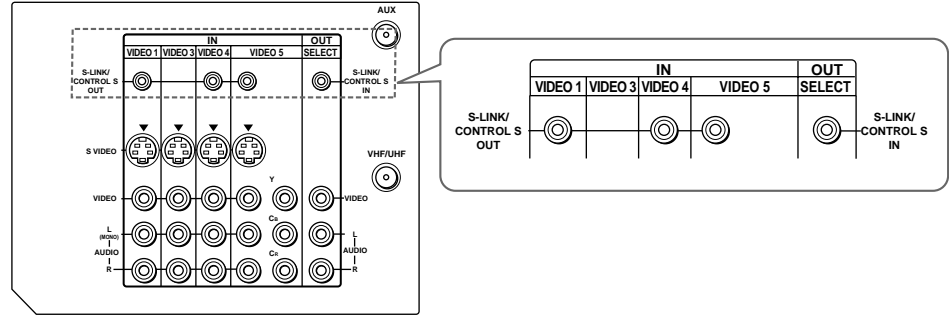

Inserting Batteries

Insert two size AA (R6) batteries (supplied) by matching the + and - on the batteries inside the remote control's battery compartment.

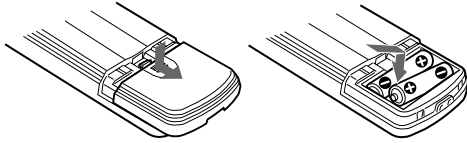

Notes:

- Remove the batteries to avoid damage from possible battery leakage whenever you anticipate that the remote control will not be used for an extended period.
- Handle the remote control with care. Avoid dropping it, getting it wet, or placing it in direct sunlight, near a heater or where the humidity is high.
- Your remote control can be programmed to operate most video equipment. (see "Operating Video Equipment" on page 52)

Using the Remote Control Joystick

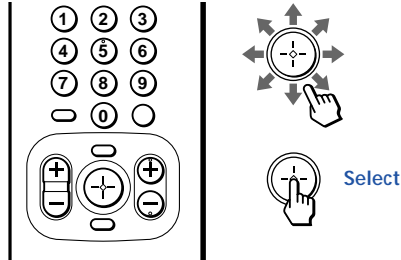

The supplied remote control has a joystick which moves the on-screen selector in eight directions. In most cases, moving the joystick up, down, left or right will cause the selector to *move* in the selected direction.

In some cases, the selector may move in eight directions according to your moving direction. Pressing down on the center of the joystick (⊕) will *activate* the selected item.

You may also move the joystick right to activate the selected item. (There are some exceptions to this option.)

Adjusting Sliders

When menu items present a slider (▬ or →), move the joystick up, down, left or right to adjust the setting.

On Line Help/Instructions

Several menu windows will provide prompts and instructions to assist you in navigating through the different functions.

When the instructions are presented, use them to supplement the instructions in this manual.

Using Your New Projection TV

Setting Up the Projection TV Automatically

The AUTO SET UP feature will allow you to set the on-screen language and set all receivable channels. The AUTO SET UP screen will appear every time you turn on the projection TV until you perform AUTO PROGRAM.

The AUTO SET UP feature does not apply for installations that use a cable box for all channel selection.

You can also set up the projection TV manually. (see "Using the CHANNEL SET UP menu" on page 43)

Notes:

- Before you perform AUTO SET UP again, make sure that the input from ANT (not AUX) is selected by pressing ANT until "AUX" does not appear next to the channel number.
- Perform this function during the day, with the antenna and/or cable properly connected, to ensure that all available channels will be broadcasting and receivable.
- When you perform AUTO PROGRAM, your CHANNEL FIX, ON/OFF TIMER, and CHANNEL BLOCK settings will be erased.
- When you perform AUTO PROGRAM, all the settings in the VIDEO, ADVANCED VIDEO and AUDIO menus are reset to the factory settings.

Using the buttons on the front panel of the projection TV:

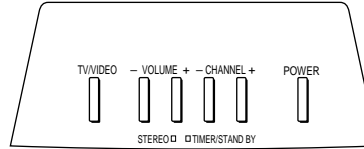

- 1 Press POWER to turn on the projection TV.
The AUTO SET UP screen appears.

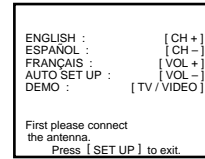

- 2 Press CHANNEL + to select English, CHANNEL - to select Spanish or VOLUME + to select French.

The screen will change to reflect your choice.

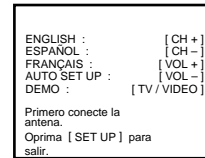
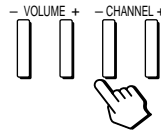

For a DEMO of functions and menus, press TV/VIDEO.

- 3 Press VOLUME - to continue.

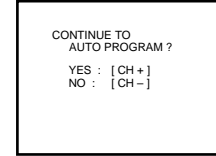

- 4 Press CHANNEL + to preset channels automatically.



"AUTO PROGRAM" appears and the projection TV starts scanning and presetting channels automatically. While scanning, the received channel will be displayed on the sub screen. When all the receivable channels are stored, the lowest numbered channel is displayed. If the projection TV receives cable TV channels, CABLE is set to ON automatically.

(continued)

Using Your New Projection TV (continued)

To perform AUTO SET UP again

- Press SET UP inside the drop-down panel on the projection TV.
- Press CHANNEL +, CHANNEL - or VOLUME + to select a language.
- Press VOLUME - to restore factory settings (“CONTINUE TO AUTO PROGRAM?” will appear on the screen. Press CHANNEL+ to execute or CHANNEL- to exit).
- Press SET UP to exit.

Adjusting the Convergence Automatically (AUTO FOCUS)

The projection tube image appears on the screen in three layers (red, green and blue). If they do not converge, the color is poor and the picture blurs.

Before you use your projection TV, be sure to adjust the convergence. The AUTO FOCUS feature allows you to adjust the convergence automatically.

Using the AUTO FOCUS button inside the drop-down panel on the projection TV:

Tip

- *It is recommended to perform AUTO FOCUS about 30 minutes after the projection TV is turned on.*

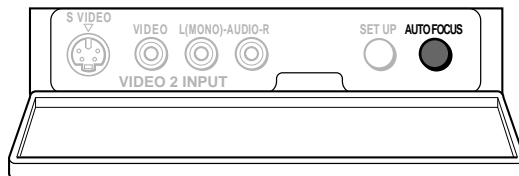

Press AUTO FOCUS.



The cross pattern appears and auto convergence works. It is completed when the cross pattern becomes white.

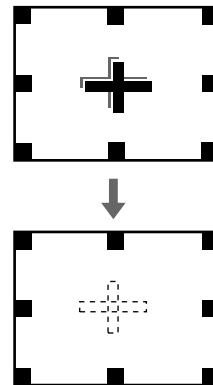

Note:

- You will not be able to perform any other functions until AUTO FOCUS has completed its cycle.

Watching the TV

Many TV features can be accessed directly through the remote control. The following chart will explain the function of some buttons found on your remote control.



REFER TO THE
ILLUSTRATION OF THE
REMOTE CONTROL ON THE
INSIDE FRONT COVER OF
THIS MANUAL AS YOU
REVIEW THIS CHART

Using the White Labeled Buttons for Projection TV Operations.

TV (FUNCTION)	Activates the remote control for use with the projection TV.
TV POWER	Turns the projection TV on and off. If a video input indication (e.g., VIDEO 1, VIDEO 2) appears on the screen, press TV/VIDEO until a channel number appears.
 and ENTER	Use for direct channel selection. Press 0-9 to select a channel (for example, to select channel 10, press 1 and 0), the channel will change after 2 seconds, or you can press ENTER for immediate selection.
CH +/-	Press to scan through the channels (+ up or – down).
VOL +/-	Press to adjust the volume (+ up or – down).
JUMP	Press to alternate or <i>jump</i> back and forth between two channels. The projection TV will jump between the current channel and the last channel selected using the 0-9 buttons.
MUTING	Press to mute the sound. “MUTING” will appear on the screen and will dim three seconds later. Press again or press VOL + to restore sound.

(continued)

PICTURE MODE

Press PICTURE MODE repeatedly to choose one of five different video modes that best suits the program you are watching directly. You can also adjust the picture items for each mode to suit your taste. When adjusting them, first select each MODE individually.

VIVID: Select for enhanced picture contrast and sharpness.

STANDARD: Select to display a standard picture.

MOVIE: Select to display a finely detailed picture.

GAME: Select to display graphics such as a video game.

PRO: Select to reproduce the original scene

For details, see “MODE” on page 35.

Using Your New Projection TV (continued)

Using the White Labeled Buttons for Projection TV Operations.	
<p>FREEZE (yellow labeled button)</p>	<p>Press to <i>freeze</i> the picture. Press again or press OFF to cancel. If you select TWIN as a FREEZE MODE in the SET UP menu, you can freeze the desired scene and display it on the left while viewing the normal picture on the right. (see "FREEZE MODE" on page 51)</p> <p>Note: If the frozen picture mode lasts for an hour, frozen mode will be canceled and the normal picture is resumed.</p>
<p>SLEEP</p>	<p>Press repeatedly until the projection TV displays the approximate time in minutes (30, 60, or 90) that you want the projection TV to remain on before shutting off automatically. Cancel by pressing until "SLEEP OFF" appears.</p>
<p>DISPLAY</p>	<p>Press to display the channel number, current time, channel caption (if set), and MTS mode (if SAP is selected). The SAP indication disappears and the other indications dim after three seconds. To turn the display off, press DISPLAY again.</p>
<p>CC</p>	<p>Press repeatedly to step through available displays:</p> <p>XDS XDS (Extended Data Service) shows a network name, program name, program type, program length, program description, call letters and time of the show if the broadcaster offers this service.</p> <p>Caption Vision Caption Vision will be displayed on the screen if the broadcaster offers this service. (see right)</p> <p>No display "OFF" appears and the display is canceled.</p>

CAPTION VISION

(Closed Caption)

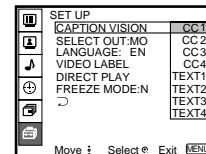

Some programs are broadcast with Caption Vision. To display Caption Vision, select **CC**1, **CC**2, **CC**3, **CC**4, TEXT1, TEXT2, TEXT3 or TEXT4 from the menu. (see "CAPTION VISION" on page 48) Then press the **CC** button until Caption Vision is displayed.

CC1, **CC**2, **CC**3 or **CC**4 shows you a caption, that is, a printed version of the dialogue or sound effects of a program. (The mode should be set to **CC**1 for most programs.) TEXT1, TEXT2, TEXT3, or TEXT4 shows you text, that is, information presented, using half of the screen. It is not usually related to the program.

Notes:

- Poor reception of TV programs can cause errors in Caption Vision and XDS. Captions may appear with a white box or other errors instead of intended text.
- XDS, Caption Vision, and the status display cannot be used at the same time.

Using the White Labeled Buttons for Projection TV Operations.

TV/VIDEO	Press repeatedly to step through available video inputs: TV, VIDEO 1, VIDEO 2, VIDEO 3, VIDEO 4 and VIDEO 5 If you select SKIP as a VIDEO LABEL in the SET UP menu, your projection TV will skip the video input you selected. (see "VIDEO LABEL" on page 49)
ANT <i>(AUX input)</i>	Press to change between the VHF/UHF input and the AUX input. (for detailed connection information, see "Cable box and cable" or "Cable and antenna" on page 3)
MTS	Press to cycle through the Multi-channel TV Sound (MTS) options. (see "MTS" on page 38)
SYSTEM OFF <i>(green labeled button)</i>	Press to turn off the projection TV and all other equipment connected with S-Link. (see "Using the S-Link/CONTROL S function" on page 19)



**REFER TO THE
ILLUSTRATION OF THE
REMOTE CONTROL ON THE
INSIDE FRONT COVER OF
THIS MANUAL AS YOU
REVIEW THIS CHART**

Using Your New Projection TV (continued)

Watching Two Programs at One Time — PIP

The Picture-in-Picture (PIP) feature allows you to view two channels simultaneously, one in the full size “main” picture and one in a smaller “window” picture.

In this feature you can move the location of a window picture as you like.

The symbol “➡” or “⬅” indicates which picture’s TV channel or input source can be changed.

The symbol “♪” indicates which picture’s sound is being received.

Main picture

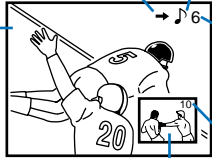

Window picture





TV channel or input-source mode for the main picture (It will dim about 3 seconds later.)

TV channel or input-source mode for the window picture (It will dim about 3 seconds later.)







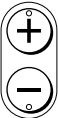

Tip

If you press RESET in PIP mode, the window picture will move to the bottom right (factory-preset location).

Using the Yellow Labeled Buttons for PIP Operations.

	<p>Press to display a window picture. Each time you press, the picture size will change (1/4 → 1/9 → 1/16). Press OFF to remove the window picture.</p>
<p>POSITION</p> 	<p>Press to move the location of the window picture (counterclockwise) around the main picture.</p>
<p>ACTIVE</p> 	<p>Press to allow you to alternate, between the main picture and the window picture, the picture for which you can change the TV channel or video source using the white labeled buttons below. The symbol “➡” (or “⬅”) will appear, to indicate which picture’s channel or input mode can be changed.</p>
 <p>(white labeled button)</p>	<p>To move the location of the window picture as you like, move and hold the joystick in any direction and release it when the picture is in the desired location.</p>
<p>TV/VIDEO</p>  <p>(white labeled button)</p>	<p>Press repeatedly to step through the available video inputs for the picture on which the symbol “➡” (or “⬅”) is displayed. (see “TV/VIDEO” on page 27)</p>

Using the Yellow Labeled Buttons for PIP Operations.

<p>CH</p>  <p>or 0-9 or JUMP</p>   <p>and ENTER</p> <p><i>(white labeled button)</i></p>	<p>Press to select the TV channel of the picture on which the symbol "➤" (or "➤") is displayed. (for details, see "Watching the TV" on page 25)</p>
<p>ANT</p>  <p><i>(white labeled button)</i></p>	<p>Press to change between the VHF/UHF input and the AUX input of the picture on which the symbol "➤" (or "➤") is displayed.</p>
<p>AUDIO</p> 	<p>Press to alternate sound between the main picture and the window picture. The symbol "♪" will appear for a few seconds to indicate which picture's sound is being received.</p>
<p>FREEZE</p> 	<p>Great for copying down phone numbers, addresses, recipes, etc. Press to freeze the main and window pictures. The symbols "➤" and "♪", and the channel number disappear. Press again to resume PIP viewing. Press OFF to cancel and resume normal TV viewing.</p>
<p>SWAP</p> 	<p>Press to switch the audio and video of the main picture and the window picture. Each time you press SWAP, the picture and sound of the two will be exchanged.</p>
	<p>Press to access CHANNEL INDEX for direct channel selection. (see "Using CHANNEL INDEX" on page 32)</p>
<p>OFF</p> 	<p>Press to cancel PIP function and return to normal viewing.</p>



REFER TO THE ILLUSTRATION OF THE REMOTE CONTROL ON THE INSIDE FRONT COVER OF THIS MANUAL AS YOU REVIEW THIS CHART

Note:

- If one of the pictures received through PIP is snowy, the entire screen may become unstable. In this case, erase the snowy channel. (see "CHANNEL SKIP" on page 43)

Using Your New Projection TV (continued)

Watching Two Programs at One Time — P&P (Twin View™)

The Picture-and-Picture (P&P) feature allows you to view two channels simultaneously, both in a reduced size screen. The main picture will appear on the right.



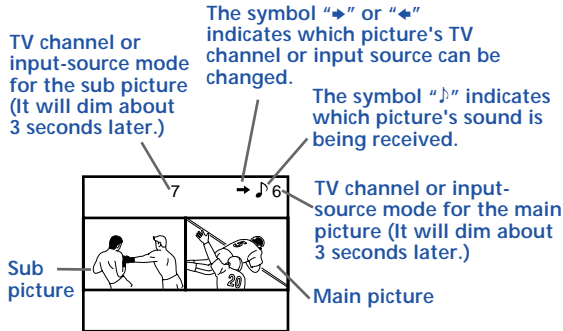

In this feature you can change the size of both pictures as you like.







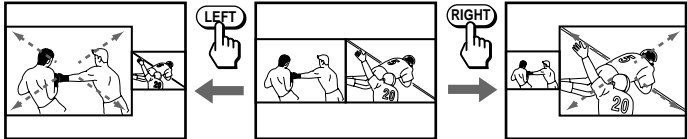



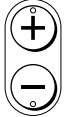

Tip

If you press RESET in P&P mode, the right and left pictures will be reset to the same size (factory-preset size.)

Using the Yellow Labeled Buttons for P&P Operations.

	<p>Press to display right (main) and left pictures. Press OFF to remove the window picture.</p>
<p>—ZOOM IN— LEFT RIGHT</p> <p>or</p> 	<p>Press and hold either RIGHT or LEFT to zoom in on the selected picture. Release at the desired size. The other picture will be zoomed out simultaneously.</p> <p>Moving and holding the joystick right or left will activate the same function.</p> 
<p>ACTIVE </p>	<p>Press to allow you to alternate, between the right and left pictures, the picture for which you can change the TV channel or video source using the white labeled buttons below. The symbol "↔" (or "↔") will appear, to indicate which picture's channel or input mode can be changed.</p>
<p>TV/VIDEO  (white labeled button)</p>	<p>Press repeatedly to step through the available video inputs for the picture on which the symbol "↔" (or "↔") is displayed. (see "TV/VIDEO" on page 27)</p>

Using the Yellow Labeled Buttons for P&P Operations.

<p>CH</p>  <p>or  -  or JUMP </p> <p>and ENTER</p> <p><i>(white labeled button)</i></p>	<p>Press to select the TV channel for the picture on which the symbol "➡" (or "⬅") is displayed. (for details, see "Watching the TV" on page 25)</p>
<p>ANT</p>  <p><i>(white labeled button)</i></p>	<p>Press to change between the VHF/UHF input and the AUX input of the picture on which the symbol "➡" (or "⬅") is displayed.</p>
<p>AUDIO</p> 	<p>Press to alternate sound between the right and left pictures. The symbol "♪" will appear for a few seconds to indicate which picture's sound is being received.</p>
<p>FREEZE</p> 	<p>Great for copying down phone numbers, addresses, recipes, etc. Press to freeze both the right and left pictures. Press again to resume P&P viewing or press  to cancel and resume normal TV viewing.</p>
<p>SWAP</p> 	<p>Press to switch the audio and video of the right and left pictures. Each time you press SWAP, the picture and sound of the two will be exchanged.</p>
<p></p>	<p>Press to cancel P&P function and return to normal viewing.</p>



REFER TO THE
ILLUSTRATION OF THE
REMOTE CONTROL ON THE
INSIDE FRONT COVER OF
THIS MANUAL AS YOU
REVIEW THIS CHART

Note:

- If one of the pictures received through P&P is snowy, the entire screen may become unstable. In this case, erase the snowy channel. (see "CHANNEL SKIP" on page 43)

Using Your New Projection TV (continued)

Using CHANNEL INDEX

You can use the CHANNEL INDEX feature to display multiple channels for direct selection.

Channels used for CHANNEL INDEX will come directly from the TV's list of receivable channels (those set during AUTO PROGRAM or through the CHANNEL SET UP menu).

1 Press .

The current channel will be reduced in size and displayed in the center of the screen in normal motion picture format. The first twelve receivable channels will appear one after another, clockwise,

surrounding the center picture. These small pictures move and pause alternately, in intervals of one second. (The channel number and channel caption (if set) on the second and later appearances will dim.)

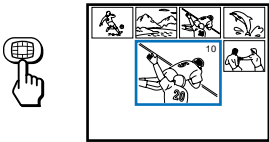

A cyan frame will appear to indicate current channel selection.

2 Move the joystick in any of eight directions to move the cyan frame to the picture that you wish to view, and press .

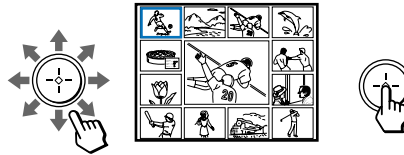

The selected channel will zoom in and move to the center, and the sound of that channel will be heard.



3 If you wish to view another channel, repeat step 2.

To view the normal picture of the selected channel, proceed to step 4.

4 Press .

The center picture will be enlarged into the whole screen for normal viewing.

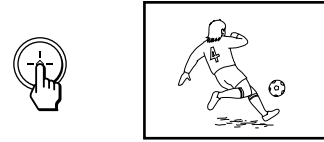

Notes:

- You cannot move the cyan frame until all of the surrounding pictures appear.
- The projection TV will continually update each of the surrounding pictures while the CHANNEL INDEX screen is displayed.
- Sound will only be heard from the center picture while the CHANNEL INDEX screen is displayed.
- If one of the pictures received through CHANNEL INDEX is snowy, the entire screen may become unstable. In this case, erase the snowy channel using CHANNEL SKIP. (see "CHANNEL SKIP" on page 43)
- If you leave the CHANNEL INDEX screen displayed for an hour without any operation, CHANNEL INDEX will be canceled and normal picture appears.



REFER TO THE
ILLUSTRATION OF THE
REMOTE CONTROL ON THE
INSIDE FRONT COVER OF
THIS MANUAL AS YOU
REVIEW THIS CHART

Using the Yellow Labeled Buttons for CHANNEL INDEX Operations.



Press to display the next twelve receivable channels.



Press to cancel the current operation and return to normal TV viewing.

FREEZE



Press to freeze the center picture.
Press again to cancel the frozen picture and resume normal center picture viewing.

Using the White Labeled Buttons for Center Picture Operations.

TV/VIDEO



Press to cycle the center picture through the video inputs.
The surrounding channels will not change.

ANT



Press to replace the center picture with a channel through between the VHF/UHF input and the AUX input.

CH

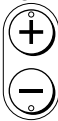

or



or



and ENTER

Press to select the channel for the center picture.
(for details, see "Watching the TV" on page 25)

Adjusting Your SET UP (menus)

Learning Menu Selection

Use the MENU button to access a menu and use the joystick to alter settings. Use the following example to learn how to modify settings.

- 1 Press the MENU button.
The main menu appears.

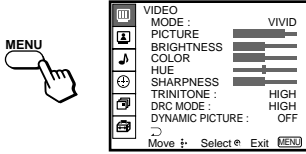

- 2 Move the joystick up or down to highlight the desired menu and press + (press down on the center of the joystick) to activate it.

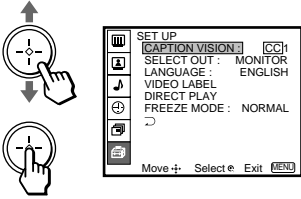

You may also move the joystick right to activate your selection.

- 3 Move the joystick up or down to highlight the desired option.

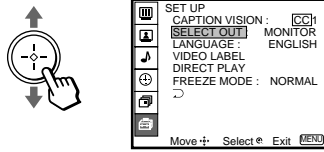

- 4 Press + (press down on the center of the joystick).
Options of your selection (Pop-up menu or Adjusting menu) will be displayed.

Pop-up menu

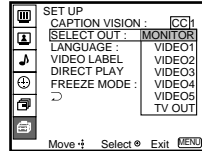

Adjusting menu

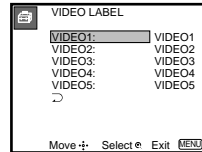

- 5 Move the joystick up or down to make your selection and press + to activate it. The previous screen will reappear.

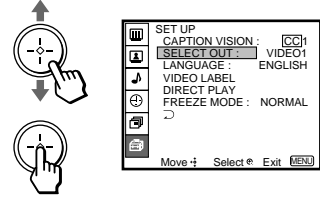

Some adjustment menus may require further operations. For details, see each menu option.

When you have finished your changes to the selected menu, choose ↵ at the bottom of the menu and press + to return to the previous screen.

You may also move the joystick left to return to the previous screen except for the slider adjustment menus.

Once you have completed all menu corrections, press MENU to exit the menu screens.

Note:

- Pressing MENU will allow you to exit from the menus at any time.

Using the VIDEO Menu

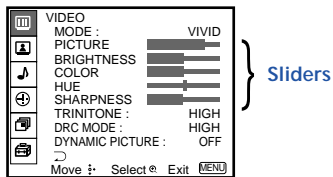

For detailed information on using the remote control to modify menu settings, refer to “Learning Menu Selection” on page 34.

To select the VIDEO menu:

Display  Highlight   Select

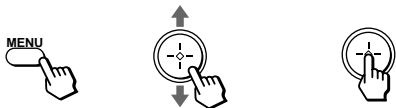

To restore the factory settings

Press RESET on the remote control while the VIDEO menu is selected. To restore each MODE to the factory setting, press RESET after selecting the mode to be reset.

Tip

Press PICTURE MODE on the remote control for direct selection of a MODE setting.

MODE <i>Customized picture viewing</i>	You can choose one of five different video modes that best suits the program you are watching. You can also adjust the picture items for each mode to suit your taste. When adjusting them, first select each MODE individually. VIVID: Select for enhanced picture contrast and sharpness. STANDARD: Select to display a standard picture. MOVIE: Select to display a finely detailed picture. GAME: Select to display graphics such as a video game. PRO: Select to reproduce the original scene.
PICTURE <i>Picture Adjustment</i>	Adjust slider right (up) to increase picture contrast. Adjust slider left (down) to decrease picture contrast.
BRIGHTNESS <i>Picture Adjustment</i>	Adjust slider right (up) to brighten the picture. Adjust slider left (down) to darken the picture.
COLOR <i>Picture Adjustment</i>	Adjust slider right (up) to increase color intensity. Adjust slider left (down) to decrease color intensity.
HUE <i>Picture Adjustment</i>	Adjust slider right (up) to increase the green tones. Adjust slider left (down) to increase the red tones.
SHARPNESS <i>Picture Adjustment</i>	Adjust slider right (up) to sharpen the picture. Adjust slider left (down) to soften the picture.
TRINITONE <i>White Intensity Adjustment</i>	HIGH: Select to give the white colors a blueish tint. MEDIUM: Select to give the white colors a neutral tint. NTSC STD: Select to give the white colors a reddish tint.

(continued)

Adjusting Your SET UP (menus) (continued)

DRC MODE <i>Digital Reality Creation</i>	The DRC feature doubles both the vertical and horizontal information of the conventional NTSC signal, allowing you to obtain a fine-detailed real picture with four times higher-density than the conventional NTSC picture. You can choose HIGH or LOW level. For graphics such as a video game, choose GAME .
DYNAMIC PICTURE <i>Black Intensity Adjustment</i>	Select ON to emphasize the black level and so produce a bolder dynamic picture. Select OFF to cancel the feature.

Tip

Since the fine-detailed DRC activated pictures contain information four times larger than conventional pictures, picture noise may appear. In this case, set NR to ON in the ADVANCED VIDEO menu.

Note:

- Some shooting games in which you point a light beam at the TV screen with an electronic gun or rifle cannot be used with this projection TV. For details, see the instruction manual applied with the video game software.

Using **ADVANCED VIDEO** Menu

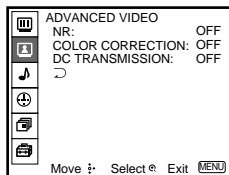

For detailed information on using the remote control to modify menu settings, refer to “Learning Menu Selection” on page 34.

To select the **ADVANCED VIDEO** menu:

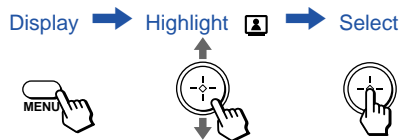

To restore the factory settings

Press **RESET** on the remote control while the **ADVANCED VIDEO** menu is selected.

Note:

- The items in the **ADVANCED VIDEO** menu can be set separately from the **MODE** settings of the **VIDEO** menu.

NR <i>Noise Reduction</i>	Select ON to reduce picture noise. Select OFF to cancel the feature.
COLOR CORRECTION <i>Color Ratio Adjustment</i>	Select ON to emphasize reds and blues. Select OFF to enhance skin tones (greens).
DC TRANSMISSION <i>Black Level Adjustment</i>	Select ON to automatically improve contrast ratio. Select OFF to reproduce the black level with no compensation.

Adjusting Your SET UP (menus) (continued)

Using the AUDIO Menu

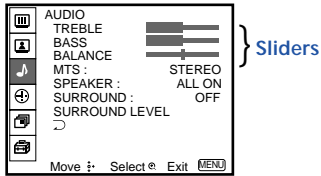

For detailed information on using the remote control to modify menu settings, refer to “Learning Menu Selection” on page 34.

To select the AUDIO menu:

Display → Highlight → Select

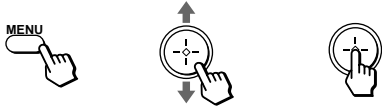

To restore the factory settings

Press RESET on the remote control while the AUDIO menu is selected.

TREBLE <i>Sound Adjustment</i>	Adjust slider right (up) to increase high pitched sounds. Adjust slider left (down) to decrease high pitched sounds.
BASS <i>Sound Adjustment</i>	Adjust slider right (up) to increase low pitched sounds. Adjust slider left (down) to decrease low pitched sounds.
BALANCE <i>Sound Adjustment</i>	Adjust slider right (up) to emphasize right speaker volume. Adjust slider left (down) to emphasize left speaker volume.
MTS <i>Enjoy stereo, bilingual and mono programs.</i>	STEREO: Select for stereo reception when viewing a program broadcast in stereo. SAP: Select to listen to a bilingual broadcast. (non-SAP programs will be muted when this feature is selected) MONO: Select for mono reception. (use to reduce noise during stereo broadcasts) Quick MTS access: Press MTS on your remote control to cycle through the MTS options as follows: (STEREO → SAP → MONO → STEREO)
SPEAKER <i>Custom selection of audio output source.</i>	ALL ON: Select to listen to the sound from the projection TV speakers alone. L/R OFF: Select to turn off the projection TV left and right speakers and listen to the left and right channel sounds through a separate audio system's speakers. ALL OFF: Select to turn off the projection TV speakers and listen to the projection TV's sound only through an external audio system's speakers. CENTER IN: Select to use the projection TV center speaker as center speaker when you connect an amplifier with Dolby Pro Logic decoder. (see “Connecting an amplifier with Dolby Pro Logic decoder” on page 18)

<p>SURROUND <i>Customize surround sound effects based on the program's audio type</i></p>	<p>SURROUND can only be set when SPEAKER is set to ALL ON or L/R OFF.</p> <p>PRO LOGIC: Produces superb theater-like surround effects. Most effective for programs encoded in Dolby surround.</p> <p>3 STEREO: Produces a dynamic three dimensional sound without using the rear speakers. The sound of the rear channel is output from the front speakers.</p> <p>SIMULATED: Adds a surround-like effect to mono programs.</p> <p>LIVE: Produces surround effects with the atmosphere of a concert hall.</p> <p>GAME: Produces maximum audio impact. Most effective for video games.</p> <p>OFF: Normal stereo or mono reception.</p>
<p>SURROUND LEVEL <i>Speaker volume adjustment for surround modes</i></p>	<p>After selecting any surround mode, adjust the volume of each speaker so that the sound will be even and natural. (see "Adjusting the speaker volume for customized surround mode" on page 40)</p>

Adjusting Your SET UP (menus) (continued)

Adjusting the Speaker Volume for Customized Surround Mode

After you set SURROUND to any mode, adjust the volume of the front, center and rear speakers to the same level so that the projection TV's sound will be even and natural. For PRO LOGIC and 3 STEREO, adjust the speaker volume using the test tone feature.

Adjusting the speaker volume

- 1 Select SURROUND LEVEL from the AUDIO menu. (see pages 38 and 39)

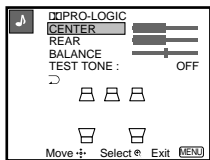

- 2 Move the joystick up or down to select the speaker for volume adjustment and press (+).

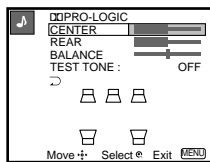
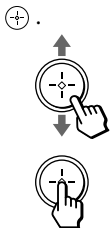

CENTER: Select to adjust the level of center speaker. (not available for SIMULATED)

REAR: Select to adjust the level of rear speakers. (not available for 3 STEREO)

BALANCE: Select to adjust the balance between right and left speakers.

- 3 Move the joystick up, down, left or right to adjust the volume level and press (+).
- 4 Use the joystick to select other speakers and to adjust the volume levels.

Adjusting the speaker volume using the test tone

The TEST TONE feature makes it easier to adjust the volume level. You can use this feature for PRO LOGIC and 3 STEREO modes only.

- 1 With the SURROUND LEVEL window open, move the joystick up or down to select TEST TONE and press (+).

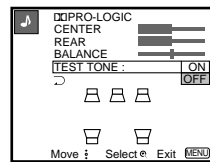

- 2 Move the joystick up or down to select ON.

A test tone will be output from each speaker in sequence:

Front left → Center → Front right → Rear



To turn off the test tone, select OFF.

- 3 Follow steps 2 through 4 in "Adjusting the speaker volume."

⊕ Using the TIMER Menu

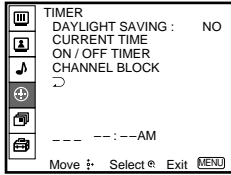

After setting the clock you can use the timer to turn the projection TV on and off.

For detailed information on using the remote control to modify menu settings, refer to “Learning Menu Selection” on page 34.

To select the **TIMER ⊕** menu:

Display → Highlight ⊕ → Select

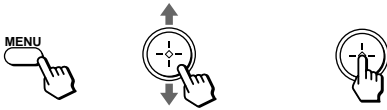

Tip ⚡

Set daylight saving time before setting the clock. Any loss of power will cause these settings to be erased.

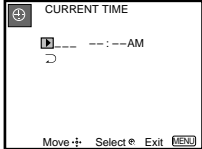
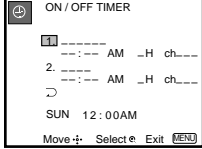
<p>DAYLIGHT SAVING <i>Automatically adjusts the time.</i></p>	<p>Spring: Select YES to compensate for Daylight Saving Time. The current time automatically moves ahead one hour. Fall: Select NO at the end of Daylight Saving Time. The current time moves back one hour.</p>
<p>CURRENT TIME SET <i>Necessary for the TIMER.</i></p>	<ol style="list-style-type: none"> 1 Press ⊕, then move the joystick up or down until the current day (MON-SUN) is displayed, and press ⊕. 2 Move the joystick up or down until the current hour (01-12) and AM/PM is displayed, and press ⊕. 3 Move the joystick up or down until the current minute (00-59) is displayed, and press ⊕. The Clock has now started. Press MENU to exit. 
<p>ON/OFF TIMER <i>Wake up or scheduled viewing.</i></p>	<ol style="list-style-type: none"> 1 Select the desired timer (1 or 2). 2 Move the joystick up or down until the desired day (MON-SUN) or range of days (EVERY SUN-SAT or EVERY MON-FRI) is displayed, and press ⊕. 3 Move the joystick up or down until the time (hours and minutes) that you want the projection TV to remain on is displayed, and then press ⊕. 4 Move the joystick up or down to set the time duration (maximum of 6 hours) and press ⊕. 5 Move the joystick up or down to select the desired channel and press ⊕. The timer is now set. The TIMER indicator on your projection TV will be lit. Press MENU to exit. To cancel your timer setting, select timer 1 or 2 and press RESET while in the ON/OFF TIMER window. Performing AUTO PROGRAM will erase all TIMER settings. 

(continued)

Adjusting Your SET UP (menus) (continued)

CHANNEL BLOCK

Prevent access to certain channels.

You will be able to block two channels for a period of up to 24 hours.

- 1 Select the desired timer (1 or 2).
- 2 Move the joystick up or down until the desired day (MON-SUN) or range of days (EVERY SUN-SAT or EVERY MON-FRI) is displayed, and press \oplus .
- 3 Move the joystick up or down until the time (hours and minutes) that you want the projection TV to turn off is displayed, and then press \oplus .
- 4 Move the joystick up or down to set the time duration (maximum of 24 hours) and press \oplus .
- 5 Move the joystick up or down to select the desired channel and press \oplus . Press MENU to exit. If you select the blocked channel during the period you set, only the symbol "⏏" is displayed in the center of the screen and the sound is muted.

To erase your CHANNEL BLOCK settings, select timer 1 or 2, then press RESET while in the CHANNEL BLOCK window. Performing AUTO PROGRAM will erase your CHANNEL BLOCK settings.

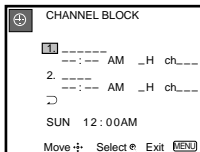

Using the CHANNEL SET UP Menu

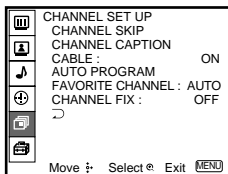

For detailed information on using the remote control to modify menu settings, refer to “Learning Menu Selection” on page 34.

To select the CHANNEL SET UP menu:

Display → Highlight → Select

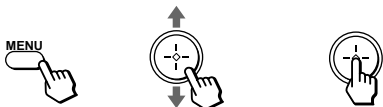

CHANNEL SKIP

Skip unnecessary channels

After AUTO SET UP, you can erase unnecessary channels from the channel preset memory. You can also recover those channels again.

With the CHANNEL SKIP window open:

- 1 Move the joystick up or down to select the desired channel. You can view the channel that is selected with the CHANNEL SKIP menu in the center sub screen. You can also use CH +/- or 0–9 and ENTER buttons.
- 2 Press \oplus .
- 3 Move the joystick up or down to select YES, and press \oplus .
The selected channel will be erased.
If you want to re-enter the skipped channel, follow the steps above and select NO.

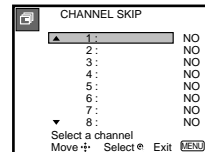

(continued)

Adjusting Your SET UP (menus) (continued)

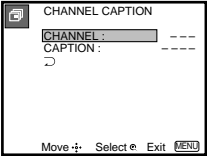
<p>CHANNEL CAPTION <i>Easy recognition of the channel you are watching</i></p>	<p>You can add a caption for up to 32 channels of both VHF/UHF and AUX inputs. You can make your own caption.</p> <p>With the CHANNEL CAPTION window open:</p> <ol style="list-style-type: none">1 Press + and then move the joystick up or down to select the desired channel. You can view the channel that is selected with the CHANNEL CAPTION menu in the center sub screen.2 Press +.3 Move the joystick up or down to display the first letter or number of the caption and press + to select it. Repeat until up to four digits are selected.4 Press +. <i>To erase a caption, press RESET.</i>	 <p>The screenshot shows a menu titled 'CHANNEL CAPTION'. It has two input fields: 'CHANNEL :' followed by a dashed line, and 'CAPTION :' followed by a dashed line. Below the caption field is a small cursor icon. At the bottom of the screen, there are navigation options: 'Move +', 'Select e', 'Exit', and 'MENU'.</p>
<p>CABLE <i>Cable system setting</i></p>	<p>Select ON if your projection TV is connected to a cable system. Select OFF if your projection TV is connected to an antenna. AUTO SET UP will set CABLE to OFF automatically if a cable channel is not available.</p>	
<p>AUTO PROGRAM <i>Automatic channel presetting</i></p>	<p>Select YES to signal the projection TV to automatically program all receivable channels. When all the receivable channels are stored, the lowest numbered channel is displayed. Select NO to cancel AUTO PROGRAM.</p>	

<p>FAVORITE CHANNEL <i>User's favorite channels</i></p>	<p>The FAVORITE CHANNEL feature enables easy access to the eight channels that you preset (or the last channel that you were watching) . (for details on how to set up this feature, see "Setting and Selecting FAVORITE CHANNEL" on page 46)</p>
<p>CHANNEL FIX <i>Locks selection of your projection TV's input (To be used in conjunction with external equipment such as a cable box, AV receiver, etc.)</i></p>	<p>2-6: When the cable box is connected to the VHF/UHF input, you can fix the TV's input by selecting channels 2-6. Press DBS/CABLE (FUNCTION) and then CH +/- to change the cable box channels.</p> <p>AUX 2-6: When a cable box is connected to AUX and a cable or antenna is connected to VHF/UHF.</p> <p>VIDEO 1: When you have connected external video equipment (e.g. AV receiver) and you want the projection TV's input fixed to it.</p> <p>OFF: When you want to switch CHANNEL FIX off.</p> <p>If the projection TV is in the AUX mode when you turn CHANNEL FIX off, press ANT to return to UHF input mode.</p> <p><i>TIMER and CHANNEL BLOCK settings are erased when CHANNEL FIX is set. (If ANT2-6 or AUX2-6 is selected, timer settings for those channels remain)</i></p>

Adjusting Your SET UP (menus) (continued)

Setting and Selecting FAVORITE CHANNEL

The FAVORITE CHANNEL feature of your new projection TV enables easy access to the eight channels that you preset (or the last channel that you were watching).

Your FAVORITE CHANNEL options can be set automatically or manually.

The factory setting for FAVORITE CHANNEL is AUTO.

When FAVORITE CHANNEL is set to AUTO, the last eight channels selected with the 0-9 buttons will be set as FAVORITE CHANNEL options. If you prefer to your own selection as FAVORITE CHANNEL options, set to MANUAL.

Setting FAVORITE CHANNEL manually

- 1 Select FAVORITE CHANNEL from the CHANNEL SET UP menu. (see page 45)

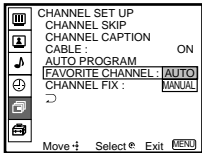

- 2 Move the joystick up or down to select MANUAL and press (+).

The FAVORITE CHANNEL menu will appear. If you set CHANNEL CAPTION, captions (e.g. CNN, HBO) for the channels will be displayed. (see "CHANNEL CAPTION" on page 44)

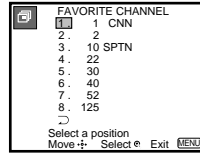
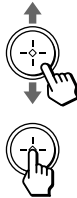

- 3 Move the joystick up or down to select a position (1-8), and press (+).

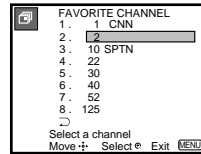

- 4 Move the joystick up or down to select a channel.

You have now selected a favorite channel for the position you selected.

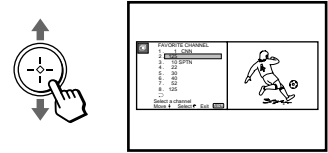

- 5 Press (+) and use the joystick to select other FAVORITE CHANNEL positions and program other favorite channels. (Follow steps 3 and 4.)

- 6 Press MENU when you have finished.

Your favorite channels are now ready to use.

Resetting FAVORITE CHANNEL choices

You have the option of returning to the FAVORITE CHANNEL screen to adjust any of your favorite channel choices.

Simply proceed as described in “Setting FAVORITE CHANNEL manually” (skip step 2 if MANUAL is already selected).

When you reach step 3, select the position you want to change and press \oplus . Press RESET to clear the channel for that position.

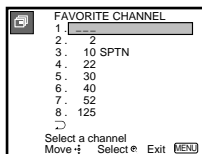

Move the joystick up or down to select a new channel.

Press MENU when you are done.

Note:

- The FAVORITE CHANNEL feature is not available for the AUX input.

Using FAVORITE CHANNEL

You can use the FAVORITE CHANNEL feature to display a favorite channel menu with a window picture for direct selection.

- 1 Press \oplus once.

The favorite channel menu and a window picture will be superimposed over the current channel. The window picture displays the channel selected from the menu.

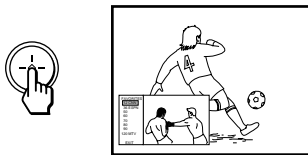

- 2 Move the joystick up or down to select a channel that you wish to view from the menu.

The picture of the selected channel will be displayed in the window picture.

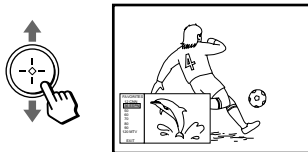

- 3 Press \oplus to select the channel.

The selected channel will be displayed for normal viewing.

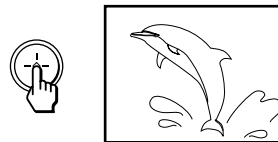

To cancel the favorite channel menu before selecting a channel, move the joystick up or down to select EXIT at the bottom of the menu and press \oplus .

Adjusting Your SET UP (menus) (continued)

Using the SET UP Menu

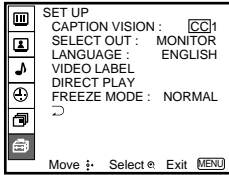

For detailed information on using the remote control to modify menu settings, refer to “Learning Menu Selection” on page 34.

To select the SET UP menu:

Display → Highlight → Select

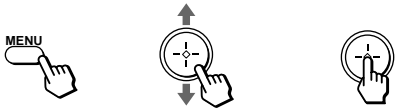

Notes:

- When you set SELECT OUT to TV OUT, you cannot swap the main/right and window/left pictures.
- The SELECT OUT signal is only available when the projection TV is on.

CAPTION VISION

Television closed
caption display

Some programs are broadcast with Caption Vision.

To display Caption Vision, select the desired option and press [CC].

CAPTION VISION options: [CC]1, [CC]2, [CC]3, [CC]4, TEXT1, TEXT2, TEXT3 or TEXT4. (for details, see “CAPTION VISION” on page 26)

SELECT OUT

Output signal
selection from
SELECT OUT

You can select the desired output signal from the SELECT OUT jacks at the rear of the projection TV.

MONITOR: Select to edit tapes while monitoring.

SELECT OUT outputs the picture displayed on the projection TV screen.

VIDEO1–VIDEO5: Select to edit tapes while viewing an input image different from that being recorded.

SELECT OUT outputs the signal input to the projection TV regardless of the displayed picture on the screen.

TV OUT: Select if you connect an AV receiver to VIDEO 1 IN. SELECT OUT outputs the signal that the TV is tuned to, regardless of the displayed picture. (see “Connecting an AV receiver” on page 16 for connection)
If you select TV OUT, a pop-up menu appears.

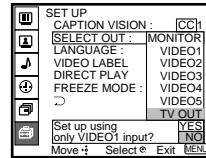
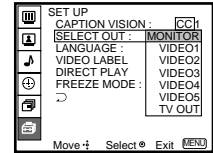

Select **YES** only if you connect an AV receiver, with no other equipment, to your projection TV. You can always select the signal from the receiver by pressing TV/VIDEO once.

Select **NO** if you connect multiple components to your projection TV. You can select an input (VIDEO1 – VIDEO5) with the TV/VIDEO button.

LANGUAGE

User's preferred language

Select from available languages (English, Spanish or French) to display all menus in your language of choice.

VIDEO LABEL

Easy recognition of connected equipment (e.g. DBS, VHS, etc.).

This feature allows you to label each input mode so that you can easily identify the connected equipment (e.g. you can label VIDEO 1 IN as VHS).

With the VIDEO LABEL window open:

- 1 Move the joystick up or down to select the input mode you want to label and press .

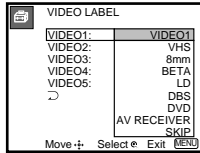

- 2 Move the joystick up or down to select the label and press .

VIDEO LABEL Options:

VIDEO 1: VIDEO 1, VHS, 8mm, BETA, LD, DBS, DVD, AV RECEIVER, SKIP

VIDEO 2–5: VIDEO 2–5, VHS, 8mm, BETA, LD, DBS, DVD, SKIP

If you select SKIP, your projection TV will skip this connection when you scan through video sources using the TV/VIDEO button.

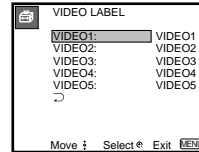

Adjusting Your SET UP (menus) (continued)

DIRECT PLAY

Easy operation of a connected VCR

This feature allows you to switch the input mode from TV to Sony's VCR (MDP or DVD) and start playing by only pressing the ► (playback) button on the remote control. You have to set the VTR 1/2/3/DVD/MDP switch on the remote control (e.g., you connect your VCR to the VIDEO 3 IN jacks and set the VTR 1/2/3/DVD/MDP switch to VTR 1). With the DIRECT PLAY window open:

- 1 Move the joystick up or down to select the input to which your video equipment is connected, and press .

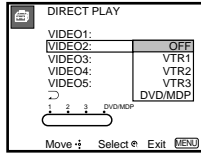

- 2 Move the joystick up or down to select the position of the VTR 1/2/3/DVD/MDP switch, and press .

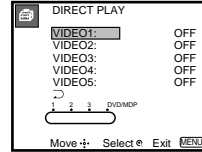

FREEZE MODE

*Freeze picture
mode*

Ideal for copying down phone numbers, addresses, recipes, etc.

NORMAL: Select to freeze the whole picture on the screen by pressing FREEZE.



The current picture freezes.

TWIN: Select to freeze the desired scene and display it on the left of the screen while viewing the normal motion picture of the current channel on the right by pressing FREEZE.

This mode is not available for PIP, P&P or CH INDEX screens.

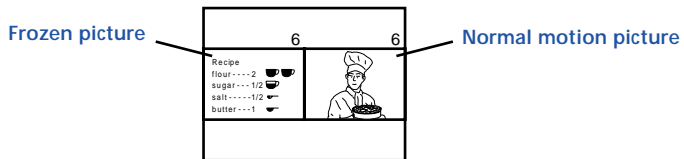

Press again or press **OFF** to display the normal picture.

Operating Video Equipment

Setting the Manufacturer's Code

You can use the supplied remote control to operate Sony or non-Sony video equipment that has an infrared sensor.

- 1 Set the VTR 1/2/3/DVD/MDP switch to the position through which you would like to access the video equipment.

The following Sony equipment is preset to each position of the switch:

VTR1 (303)	Beta, ED Beta VCRs
VTR2 (302)	8 mm VCR
VTR3 (301)	VHS VCR
DVD/MDP (751)	DVD Player

- 2 Press CODE SET, DVD/VTR (FUNCTION), the 0-9 buttons to enter the manufacturer's code number (see the following chart), then press ENTER.

For example, to operate a Sony 8mm VCR:



If the remote control doesn't work

- See the note on page 54.

VCR manufacturer code numbers

Manufacturer	Code
Sony	301, 302, 303
Aiwa	338
Admiral (M. Ward)	327
Audio Dynamic	314, 337
Bell & Howell (M. Ward)	330, 343
Broksonic	319, 317
Canon	309, 308
Citizen	332
Craig	315, 302, 332
Criterion	315
Curtis Mathis	304, 338, 309
Daewoo	341, 312, 309
DBX	314, 336, 337
Dimensia	304
Emerson	319, 320, 316, 317, 318, 341
Fisher	330, 334, 335, 333
Funai	338
General Electric	329, 304, 309
Go Video	340, 339, 322
Goldstar	332
Hitachi	306, 304, 305, 338
Instant Replay	309, 308
JC Penney	309, 305, 304, 330, 314, 336, 337
JVC	314, 336, 337
Kenwood	314, 336, 332, 337
LXI (Sears)	332, 305, 333, 334, 330, 335, 338
Magnavox	308, 309, 310
Marantz	314, 336, 337
Marta	332
Memorex	309, 335
Minolta	305, 304

Mitsubishi/MGA	323, 324, 325, 326
Multitech	325, 338, 321
NEC	314, 336, 337
Olympic	309, 308
Optimus	327
Panasonic	308, 309, 306, 307
Pentax	305, 304
Philco	308, 309
Philips	308, 309, 310
Pioneer	308
Quasar	308, 309, 306
RCA/PROSCAN	304, 305, 308, 309, 311, 329, 312, 313, 310
Realistic	309, 330, 328, 335, 324, 338
Sansui	314
Singer	315
Samsung	322, 313, 321
Sanyo	330, 335
Scott	312, 313, 321, 335, 323, 324, 325, 326
Sharp	327, 328
Shintom	315
Signature 2000 (M. Ward)	338, 327
Sylvania	308, 309, 338, 310
Symphonic	338
SV2000	338
Tashiro	332
Tatung	314, 336, 337
Teac	314, 336, 338, 337
Technics	309, 308
Teknica	342, 338
Toshiba	312, 311
Wards	327, 328, 335, 331, 332
XR-1000	315
Yamaha	330, 314, 336, 337
Zenith	331

Operating Video Equipment (continued)

MDP manufacturer code numbers

Manufacturer	Code
Sony	701
Panasonic	704
Pioneer	702

DVD Player manufacturer code numbers

Manufacturer	Code
Sony	751
Panasonic	753
Pioneer	752
RCA	755
Toshiba	754









Tips

- In some rare cases, you may not be able to operate your non-Sony video equipment with the supplied remote control. In this case, please use the equipment's own remote control.
- When you remove the batteries, the code number may revert to the factory setting.



To operate video equipment



- 1 Set the VTR1/2/3/DVD/MDP switch to the position through which you would like to access the video equipment.
- 2 Use the VCR/DVD/MDP buttons indicated in the following tables.

Operating a VCR using the remote control

To turn On/Off	Press DVD/VTR (POWER). [Green Button]
To select a channel	Press the 0 – 9 buttons.
To change channels	Press CH +/-.
To record	Press  (REC) while pressing  (lower).
To play	Press  .
To stop	Press  .
To fast forward	Press  .
To rewind the tape	Press  .
To pause	Press  . Press again to resume normal playback.
To search the picture forward or backward	Press  or  during playback. Release to resume normal playback.
To change input mode	Press TV/VTR.





Operating an MDP using the remote control

To turn On/Off	Press DVD/VTR (POWER). [Green Button]
To play	Press  .
To stop	Press  .
To pause	Press  . Press again to resume normal playback.

To search the picture forward or backward	Press  or  during playback. Release to resume normal playback.
---	--

To search a chapter forward or backward	Press CH +/-.
---	---------------

Operating a DVD Player using the remote control

To turn On/Off	Press DVD/VTR (POWER). [Green Button]
To play	Press  .
To stop	Press  .
To pause	Press  . Press again to resume normal playback.
To step through different tracks of an audio disc	Press  to step forward or  to step backward.
To step through different chapters of a video disc	Press CH+ to step forward or CH- to step backward.
To display the Title menu	Press TITLE.
To display the DVD menu	Press DVD MENU.
To select tracks directly	Press 0-9 buttons.
To display the menu (Set up)	Press MENU.

Operating a Cable Box or DBS Receiver

Setting the Manufacturer's Code

You can program the supplied remote control to operate a cable box or DBS receiver.

Press CODE SET, DBS/CABLE (FUNCTION), the 0-9 buttons to enter the manufacturer's code number (see the following chart), then press ENTER.

For example, to operate a Sony DBS receiver:

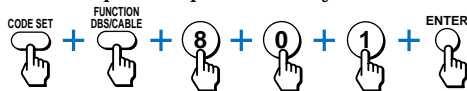

Manufacturer code numbers (cable box)

Manufacturer	Code
Gemini	233
Hamlin/Regal	222, 223, 224, 225, 226
Jerrold/G. I.	201, 202, 203, 204, 205, 222, 206, 207, 208, 218
Macom	230, 231, 232
Magnavox	234
Oak	227, 228, 229
Panasonic	219, 220, 221
Philips	236, 237, 238, 239, 240, 241
Pioneer	214, 215
Samsung	235
Scientific Atlanta	209, 210, 211
Tocom	216, 217
Zenith	212, 213

Manufacturer code numbers (DBS receiver)

Manufacturer	Code number
Sony	801 (preset code for remote control)
General Electric	802
RCA/PROSCAN	802

To operate the projection TV

Press TV (FUNCTION). Then use the projection TV control buttons to control the projection TV.

For more details on operating the cable box or DBS receiver

Refer to the operating instructions that come with the equipment.

If the remote control doesn't work

- Try repeating the set up procedures using the other codes listed for your equipment.

Tips

- If more than one code number is listed, try entering them one by one until you come to the correct code for your equipment.
- If you enter a new code number, the code number you previously entered at that setting is erased.
- In some rare cases, you may not be able to operate your equipment with the supplied remote control. In this case, use the equipment's own remote control unit.
- Whenever you remove the batteries — to replace them, for example — if too much time is taken, the code numbers may revert to the factory setting and must be reset.

Troubleshooting

If, after reading the following instructions, you have additional questions related to the use of your Sony projection TV, please call one of the following numbers (English only).

Customers in the continental United States contact the Direct Response Center at:
1-800-222-SONY (7669)

Customers in Canada contact the Customer Relations Center at:
(416) 499-SONY (7669)

The picture turns off and the **TIMER/STAND BY** indicator on the front panel flashes (self-diagnosis function)

- The projection TV is equipped with a self-diagnosis function. If there is a problem with your projection TV, the **TIMER/STAND BY** indicator on the front panel will flash repeatedly. Counting the number of flashes helps you inform qualified Sony personnel of the projection TV's condition.

Front of the projection TV

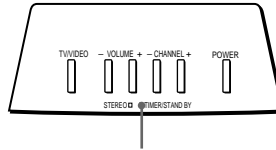

TIMER/STAND BY indicator

- Count how many times the **TIMER/STAND BY** indicator flashes in total. It flashes twice at 3 seconds' intervals. If, for example, the indicator flashes twice, stops flashing for 3 seconds, and flashes twice again, that counts as twice.
- Press **POWER** on the projection TV to turn it off, then inform qualified Sony personnel or the above Direct Response Center of the number of flashes.

No picture (screen not lit), no sound

- Make sure the power cord is plugged in.
- Operate with the buttons on both the projection TV and the remote control.
- Check to see if the **TV/VIDEO** setting is correct: when watching TV, set to **TV**, and when watching video tapes, set to **VIDEO 1, 2, 3, 4 or 5**.
- Try another channel. *It could be station trouble.*
- Perform **AUTO SET UP** again using the **SET UP** button to return to the factory preset condition. (see "To perform **AUTO SET UP** again" on page 24)

Remote control does not operate

- Batteries could be weak. Replace the batteries.
- Press **TV (FUNCTION)** when operating your projection TV.
- Make sure the projection TV's power cord is connected securely to the wall outlet.
- Locate the projection TV at least 3-4 feet away from fluorescent lights.
- Check the **S-Link** connection. (see "Using the **S-Link/CONTROL S** function" on page 19)
- Check the polarity of the batteries.

Troubleshooting (continued)

Dark, poor or no picture (screen lit), good sound

- Adjust PICTURE in the VIDEO menu. (see "PICTURE" on page 35)
- Adjust BRIGHTNESS in the VIDEO menu. (see "BRIGHTNESS" on page 35)
- Check antenna/cable connections.
- Perform AUTO SET UP again using the SET UP button to return to the factory preset condition. (see "To perform AUTO SET UP again" on page 24)
- Adjust the convergence again using the AUTO FOCUS button. (see "Adjusting the convergence automatically (AUTO FOCUS) on page 24")

Good picture, no sound

- Press MUTING so that "MUTING" disappears from the screen. (see "MUTING" on page 25)
- Check the MTS setting in the AUDIO menu. (see "MTS" on page 38)
- Make sure SPEAKER is set to ALL ON or L/R OFF in the AUDIO menu. (see "SPEAKER" on page 38)
- Perform AUTO SET UP again using the SET UP button to return to the factory preset condition. (see "To perform AUTO SET UP again" on page 24)

Cannot receive upper channels (UHF) when using an antenna

- Make sure CABLE is OFF in the CHANNEL SET UP menu. (see "CABLE" on page 44)
- Use AUTO PROGRAM to add receivable channels that are not presently in TV memory. (see "AUTO PROGRAM" on page 44)

No color

- Adjust the COLOR in the VIDEO menu. (see "COLOR" on page 35)
- Black and white programs cannot be seen in color.
- Perform AUTO SET UP again using the SET UP button to return to the factory preset condition. (see "To perform AUTO SET UP again" on page 24)

Only snow and noise appear on the screen

- Check the CABLE setting in the CHANNEL SET UP menu. (see "CABLE" on page 44)
- Check the antenna/cable connections.
- Make sure the channel is broadcasting programs.
- Press ANT to change the input mode. (see "ANT" on page 27)

Dotted lines or stripes

- Adjust the antenna.
- Move the projection TV away from noise sources such as cars, neon signs or hair-dryers.

Noisy picture (when DRC is set to HIGH in the VIDEO menu)

- Soften the sharpness using SHARPNESS in the VIDEO menu.

TV is fixed to one channel

- Try turning CHANNEL FIX off. (see "CHANNEL FIX" on page 45)
- Use AUTO PROGRAM to add receivable channels that are not presently in the TV memory. (see "AUTO PROGRAM" on page 44)

Double images or ghosts

- Use a highly directional outdoor antenna or a cable (when the problem is caused by reflections from nearby mountains or tall buildings).

Cannot operate menu

- If the item you want to choose appears in gray, you cannot select it. Press TV/VIDEO correctly.

Cannot receive any channels when using cable TV

- Make sure CABLE is ON in the CHANNEL SET UP menu. (see “CABLE” on page 44)
- Use AUTO PROGRAM to add receivable channels that are not presently in TV memory. (see “AUTO PROGRAM” on page 44)

Cannot gain enough volume when using a cable box

- Increase the volume at the cable box. Then press TV (FUNCTION) and adjust the projection TV’s volume.

Projection TV malfunctions when using the S-Link function

- Make sure the projection TV’s power cord is connected securely to the wall outlet.
- Check the S-Link connection. (see “Using the S-Link/CONTROL S function” on page 19)

INDEX does not display all available channels

- Make sure CABLE is ON in the CHANNEL SET UP menu. (see “CABLE” on page 44)
- Use AUTO PROGRAM to add receivable channels that are not presently in the TV memory. (see “AUTO PROGRAM” on page 44)

FAVORITE CHANNEL does not display your choices

- Verify that FAVORITE CHANNEL is set to MANUAL in the CHANNEL SET UP menu. (see “Setting FAVORITE CHANNEL manually” on page 46)

Some video sources do not appear when you press TV/VIDEO

- Ensure that VIDEO LABEL is not set to SKIP. (see “VIDEO LABEL” on page 49)

Recording through SELECT OUT does not function properly when recording in PIP or P&P mode

- SELECT OUT will not record both images in PIP or P&P. Only the main picture will be recorded.
- If you are recording the main picture and you switch to the sound of the sub picture using the AUDIO button, the main picture will be recorded with sound from the other program.

Cannot play shooting game

- Some shooting games in which you point a light beam at the TV screen with an electronic gun or rifle cannot be used with this projection TV. For details, see the instruction manual applied with the video game software.

Specifications

Projection system

3 picture tubes, 3 lenses, horizontal in-line system

Picture tube

7-inch high-brightness monochrome tubes (6.3 raster size), with optical coupling and liquid cooling system

Projection lenses

High performance, large diameter hybrid lens F1.1

Television system

American TV standard

Channel coverage

VHF: 2-13/UHF: 14-69/CATV: 1-125

Antenna

75 ohm external terminal for VHF/UHF

Screen size (measured diagonally)

53 inches (KP-53XBR200)

61 inches (KP-61XBR200)

Inputs/outputs

VIDEO 1/3/4 IN

VIDEO 2 INPUT

S VIDEO IN (4-pin mini DIN):

Y: 1 Vp-p, 75-ohms unbalanced, sync negative

C: 0.286 Vp-p (Burst signal), 75 ohms

VIDEO (phono jack): 1 Vp-p, 75-ohms

unbalanced, sync negative

AUDIO (phono jacks): 500 mVrms (100%

modulation), Impedance: 47 kilohms

VIDEO 5 IN

S VIDEO IN (4-pin mini DIN):

Y: 1 Vp-p, 75-ohms unbalanced, sync negative

C: 0.286 Vp-p (Burst signal), 75 ohms

VIDEO (phono jack): 1 Vp-p, 75-ohms

unbalanced, sync negative

AUDIO (phono jacks): 500 mVrms (100% modulation), Impedance: 47 kilohms

Y: 1 Vp-p, 75 ohms, sync negative

C_B: 0.7 Vp-p, 75 ohms

C_R: 0.7 Vp-p, 75 ohms

SELECT OUT

VIDEO (phono jack): 1 Vp-p, 75-ohms unbalanced, sync negative

AUDIO (phono jacks): 470 mVrms (100% modulation), Impedance: 47 kilohms

AUDIO (VAR) OUT (phono jacks): 950 mVrms (100% modulation)

AUDIO (FIX) OUT (phono jacks): 500 mVrms (100% modulation)

S-LINK

minijacks

CONTROL S IN/OUT

minijacks

Speaker

Front (Tweeter):

50 mm (2") x 2

Front (Woofer):

130 mm (5") x 2 (KP-53XBR200)

160 mm (6 3/8") x 2 (KP-61XBR200)

Center: 100 mm (4") x 2

Rear: 70 mm (2 3/4") x 4

Speaker output

Front: 20 W x 2

Center: 20 W x 1

Rear: 10 W x 2

Power requirement

120 V AC, 60 Hz

Power consumption

In use (Max.): 300 W

In standby: 1 W

Dimensions (W/H/D)

1,322 x 1,439 x 621 mm (52 1/8 x 56 3/4 x 24 1/2 inches) (KP-53XBR200)

1,573 x 1,533 x 702 mm (62 x 60 3/8 x 27 3/4 inches) (KP-61XBR200)

Mass

127 kg (281 lbs) (KP-53XBR200)

168 kg (371 lbs) (KP-61XBR200)

Supplied accessories

Remote control RM-Y902 (1)

Batteries (2) size AA (R6)

Rear speakers (2)

Speaker cords (2)

Optional accessories

Connecting cables

RK-74A, RKG-69HG, VMC-10HG,

VMC-720M, VMC-810S/820S, YC-15V/30V





U/V mixer EAC-66

Side rack

SU-53XBR200 (for KP-53XBR200)

SU-61XBR200 (for KP-61XBR200)

Design and specifications are subject to change without notice.

A		CHANNEL INDEX	32
ACTIVE button	30	CHANNEL SKIP	43
Adjusting your SET UP	34	CHANNEL SET UP menu operations 	43–45
ADVANCED VIDEO menu operations 	37	COLOR	35
ANT	27	COLOR CORRECTION	37
Antenna cable	5	CONTROL S feature	21
Antenna connector	4	Connecting TV to	
AUDIO button	29	amplifier with Dolby Pro Logic decoder	18
AUDIO menu operations 	38–40	antenna	4
Audio/Video Cable	4	audio system	17
AUTO FOCUS	24	AV receiver	16
AUTO PROGRAM	44	cable	5
AUTO SET UP	23	cable box and cable	5
AUX Hookup	5, 27	camcorder	12
B		DBS receiver	10
BALANCE	38	DBS receiver and VCR	11
BASS	38	DVD Player	14, 15
Battery installation	22	two VCRs	13
BRIGHTNESS	35	VCR	6, 7
C		Convergence	23
CABLE	44	CURRENT TIME SET	41
Cable box	5, 8, 9	D	
operation	54	DAYLIGHT SAVING	41
Caption Vision 	26	DBS receiver operation	54
CATV cable	5	DC TRANSMISSION	37
Coaxial cable	4, 6	DRC	36
CH +/-	25	DVD	
CHANNEL BLOCK	42	connection	14, 15
CHANNEL CAPTION	44	operation	53
CHANNEL FIX	45	DYNAMIC PICTURE	36
		E	
		Editing using SELECT OUT	13
		F, G	
		Factory settings	35, 37, 38
		FAVORITE CHANNEL	
		Setting	46
		Selecting	47
		FREEZE button	26, 29, 31
		FREEZE mode	
		NORMAL	51
		TWIN	51
		H	
		Hook Ups	4
		HUE	35
		I	
		Input-source mode	28, 30
		J, K	
		Joystick	22
		JUMP button	25
		L	
		LANGUAGE selection	24, 49
		Learning menus	
		ADVANCED VIDEO	37
		AUDIO	38
		CHANNEL SET UP	43
		SET UP	48
		TIMER	41
		VIDEO	35

Index (continued)

M

MDP operation	53
Menu selection	34

MODE

GAME	35
MOVIE	35
PRO	35
STANDARD	35
VIVID	35

MTS

MONO	38
SAP	38
STEREO	38

MUTING button	25
---------------------	----

N

NR	37
----------	----

O

On Line Help	22
ON/OFF TIMER	41
Operating video equipment	53

P, Q

PICTURE	35
Picture and Picture (P&P)	30
Picture-in-Picture (PIP)	28
PIP/P&P operations	
ACTIVE	28, 30
AUDIO	29, 31
CH+/-	29, 31
CHANNEL INDEX	29



FREEZE	29, 31
POSITION	28
SWAP	29, 31
TV/VIDEO	28, 30
ZOOM IN	30

R

Rear speaker	3
Remote control	22
Function buttons	25
Graphic Illustration	(inside cover)

S

SAP	38
S-Link cable	4
S-Link connector	19
S-Link function	19
S Video cable	4
Safety	1
Select buttons	22
Adjusting sliders	22
SET UP menu operations 	48-51
Setting Up the projection TV Automatically	23
SHARPNESS	35
SLEEP button	26
Sliders	22
SPEAKER	
ALL OFF	38
ALL ON	38
CENTER IN	38
L/R OFF	38

Specifications	57
Splitter	8, 9
SURROUND	
 STEREO	39
GAME	39
LIVE	39
 PRO-LOGIC	39
SIMULATED	39
SURROUND LEVEL	39, 40
SWAP button	29, 31
SYSTEM OFF	27

T, U

TEST TONE	40
TIMER menu operations 	41, 42
TREBLE	38
TRINITONE	35
Troubleshooting	55, 56
TV (FUNCTION) button	25
TV POWER button	25
TV/VIDEO button	27

V, W

VCR	6-9
VCR manufacturer code numbers	52
VCR operation	53
VIDEO LABEL	49
VIDEO menu operations 	35, 36
VOL +/-	25

X

XDS	26
-----------	----

Y, Z

Y/Cb/Cr	15
---------------	----