

Trinitron Color TV

Operating Instructions _____ **GB**

Before operating the unit, please read this manual thoroughly and retain it for future reference.

_____ **CT**

#####

_____ **CS**

#####

KV-EF34

WARNING

- Dangerously high voltages are present inside the TV.
- Operate the TV only between 110 – 240 V AC.

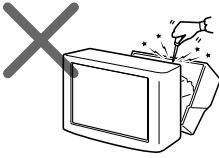

Do not open the cabinet or the rear cover of the TV. Refer servicing to qualified personnel.

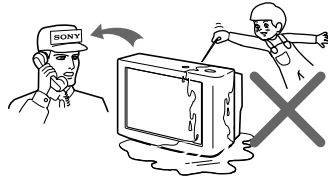

Do not operate the TV if any liquid or solid object falls into it. Have it checked immediately by qualified personnel only.

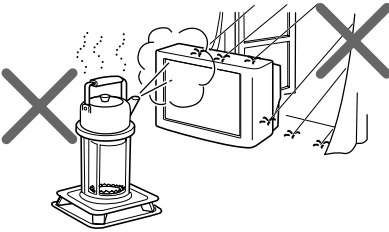

To prevent fire or shock hazard, do not expose the TV to rain or moisture.

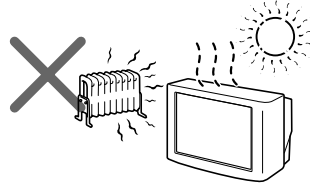

Do not install the TV in hot, humid or excessively dusty places.

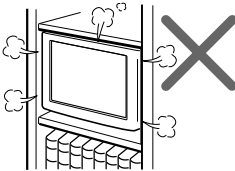

Do not install the TV in a confined space, such as a bookcase or built-in cabinet. Do not block the ventilation openings of the TV.

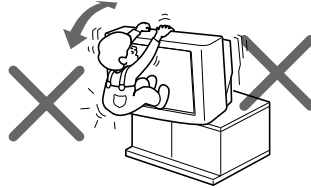

Install the TV in a stable position. Do not allow children to climb onto it.

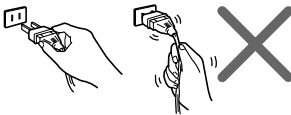

Do not pull the power cord to disconnect the TV. Pull it out by the plug.

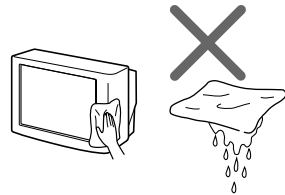

Clean the TV with a dry soft cloth. Do not use benzine, thinner, or any other chemicals to clean the TV. Do not scratch the picture tube.

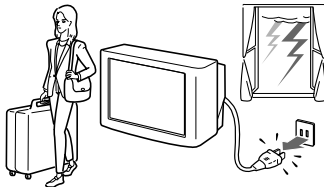

Disconnect the power cord during lightning storms or if you are not going to use the TV for several days.

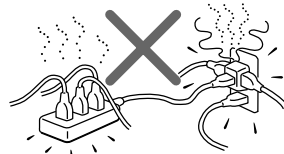

Do not plug too many appliances into the same power socket. Do not damage the power cord.

Table of Contents

WARNING





Using Your New TV

Getting Started	4
Step 1: Connect the antenna	4
Step 2: Insert the batteries into the remote	5
Step 3: Preset the channels automatically	5
Connecting optional components	6
Securing the TV	8
Watching the TV	9

Advanced Operations

Viewing your favorite channels —FAVORITE CHANNEL	14
Watching two programs at the same time—PIP, TWIN	15
Displaying multiple programs —PROGRAM INDEX	17
Listening with surround sound	20
Selecting a stereo or bilingual program	21
Operating optional components	23

Adjusting Your Setup (MENU)

Introducing the menu system	25
Changing the A/V CONTROL setting 	27
Changing the MULTI PICTURE setting 	29
Changing the SET UP setting 	31
Changing the CH. PRESET setting 	34

Additional Information

Troubleshooting	37
Self-diagnosis function	40
Identifying parts and controls	41
Specifications	Back cover

The features you will enjoy include:

- FAVORITE CH for quick and easy program selection (page 14)
- PIP & TWIN for viewing two programs (page 15)
- PROGRAM INDEX for displaying multiple programs (page 17)
- PICTURE/SOUND/SURROUND modes for customizing your TV

Your TV also offers the following setup features:

- Menu language options—English/Chinese (page 11)
- CHILD LOCK for locking out specific channels (page 32)
- INTELLIGENT VOL for automatic volume adjustment (page 31)
- FINE tuning feature (page 36)

Getting Started

Step 1

Connect the antenna

If you wish to connect a VCR, see the “Connecting a VCR” diagram below.

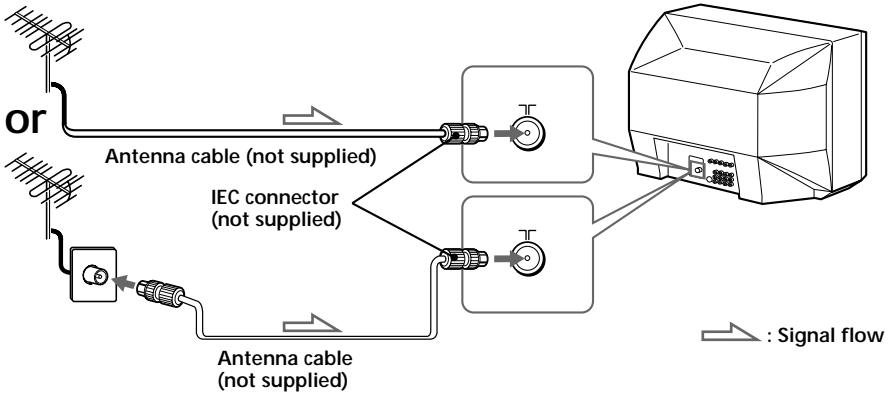

CAUTION







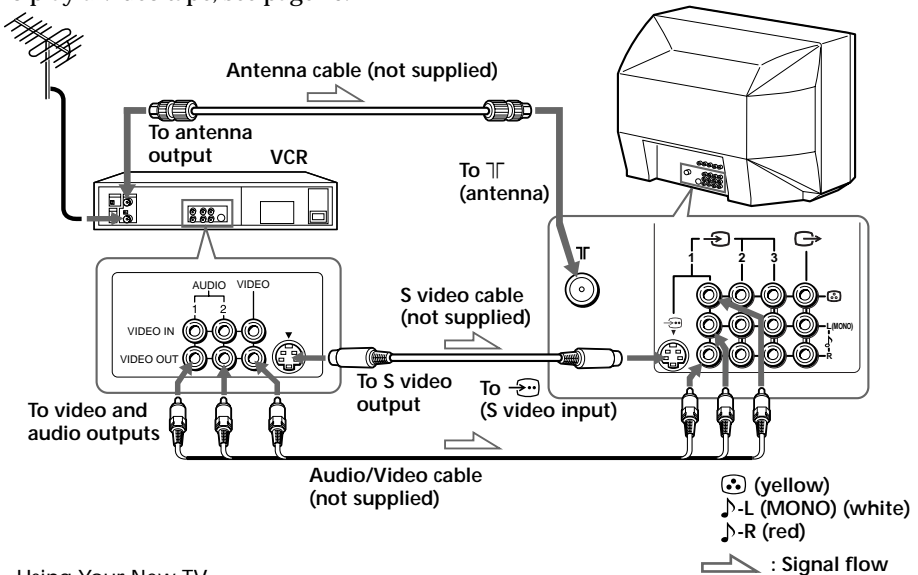

Do not connect the power cord until all other connections are complete; otherwise, a minimal current leakage through the antenna and/or other terminals to the ground could occur.

Connecting a VCR

To play a video tape, see page 10.



Notes

- If you connect a monaural VCR, connect the yellow plug to  (the yellow jack) and the black plug to -L (MONO) (the white jack).
- If you connect a VCR to the  (antenna) terminal, preset the signal output from the VCR to the program number 0 on the TV.
- Do not have concurrent connections of video equipment to the  3 (video input) jacks at the front and the  3 (video input) jacks at the rear of your TV; otherwise, the picture will not be displayed properly on the screen.
- When both the  (S video input) and  1 (video input) are connected, the  (S video input) is automatically selected. To view the video input to  1 (video input), disconnect the S video cable.

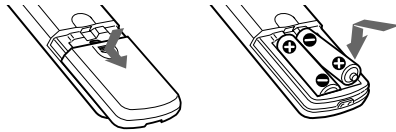
Step 2**Insert the batteries into the remote****Note**

- Do not use old batteries or different types of batteries together.

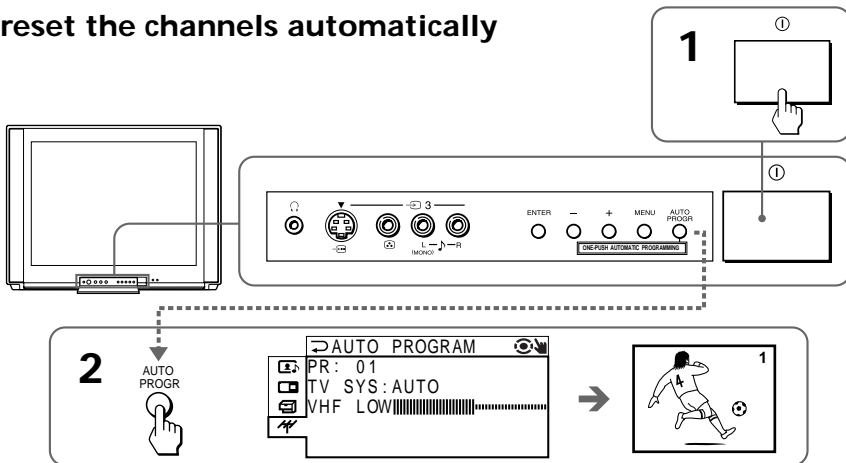
Step 3**Preset the channels automatically****Tip**

- To stop the automatic channel presetting, press MENU twice.

Now You Are Ready. . .

The channels are now automatically preset in your TV. To preset the channels manually, see page 35.

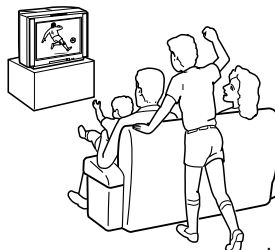





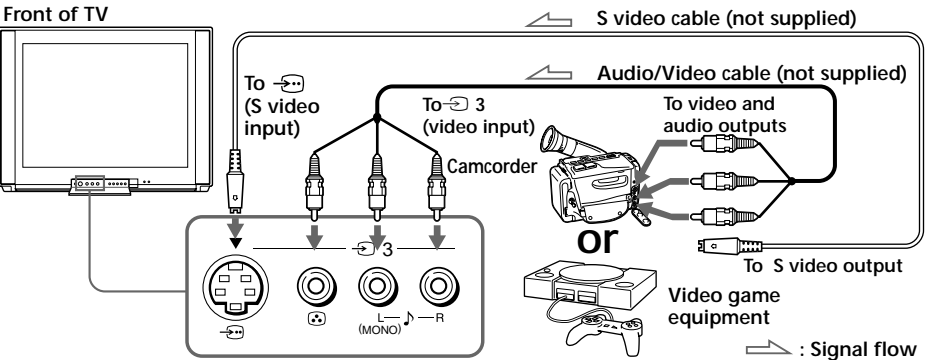

Connecting optional components

You can connect optional audio/video components, such as a VCR, multi disc player, camcorder, video game, or stereo system. For operations of the connected equipment, see pages 10 and 23.

Connecting a camcorder/video game equipment using the (video input) jacks





Notes

- You can also connect video equipment to the  1, 2, or 3 (video input) jacks at the rear of your TV.
- Do not have concurrent connections of video equipment to the  3 (video input) jacks at the front and the  3 (video input) jacks at the rear of your TV; otherwise, the picture will not be displayed properly on the screen.
- When both the  (S video input) and  3 (video input) are connected, the  (S video input) is automatically selected. To view the video input to  3 (video input), disconnect the S video cable.

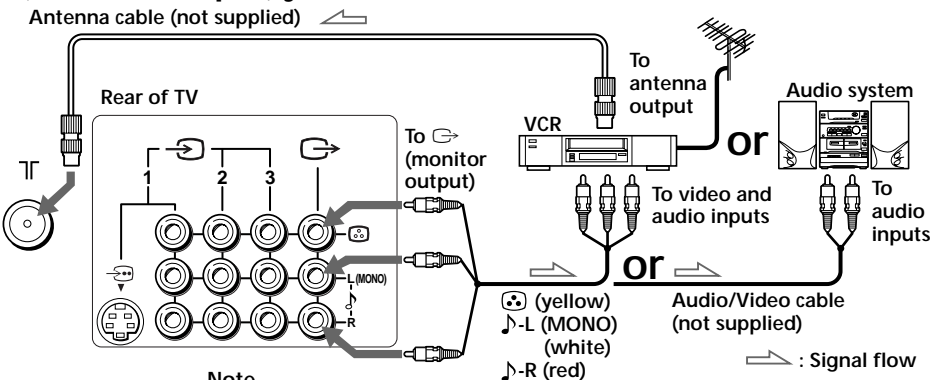
Connecting audio/video equipment using the (monitor output) jacks



Note



- When connecting a monaural VCR, connect the yellow plug to  (the yellow jack) and the black plug to  -L (MONO) (the white jack).

Connecting a DVD player

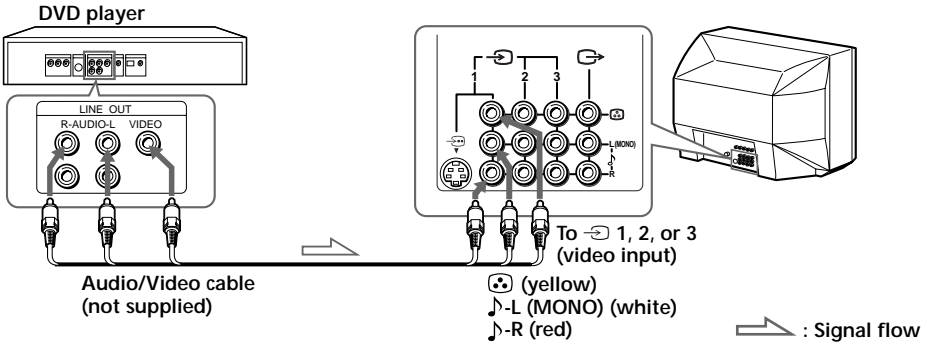
Connect 1, 2, or 3 (video input)  (audio/video) connectors on your TV to LINE OUT on your DVD player.



Connecting a DVD player with component video output connectors

- 1 Connect R and L under  (component video input) on your TV to the LINE OUT, AUDIO R and L output connectors on your DVD player.
- 2 Using a component video cable, connect Y, C_B, and C_R under  (component video input) on your TV to the COMPONENT VIDEO OUT Y, C_B, and C_R output connectors on your DVD player.

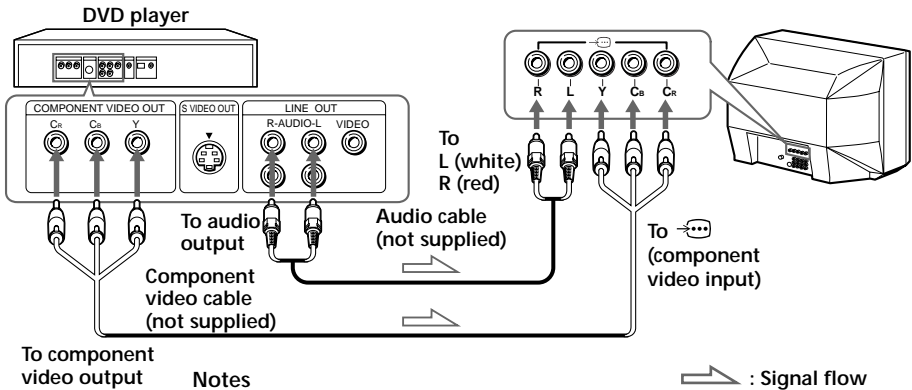

Notes

- Some DVD player terminals may be labeled differently:

Connect	To (on the DVD player)
Y (green)	Y
C _B (blue)	C _b , B-Y or P _B
C _R (red)	C _r , R-Y or P _R

- Since the high quality pictures on a DVD disc contain a lot of information, picture noise may appear. In this case, adjust the sharpness ("SHARP") in the PERSONAL ADJUST menu of the PICTURE MODE menu (see page 28).
- Connect your DVD player directly to your TV. Connecting the DVD player through other video equipment will cause unwanted picture noise.

Securing the TV

To prevent the TV from falling, secure the TV using one of the following methods:

A With the supplied screws, attach the stabilizer band to the TV stand and to the rear of the TV using the provided hole.

OR

B Pass a cord or chain through the clamps and secure them to the rear of the TV and a wall or pillar.

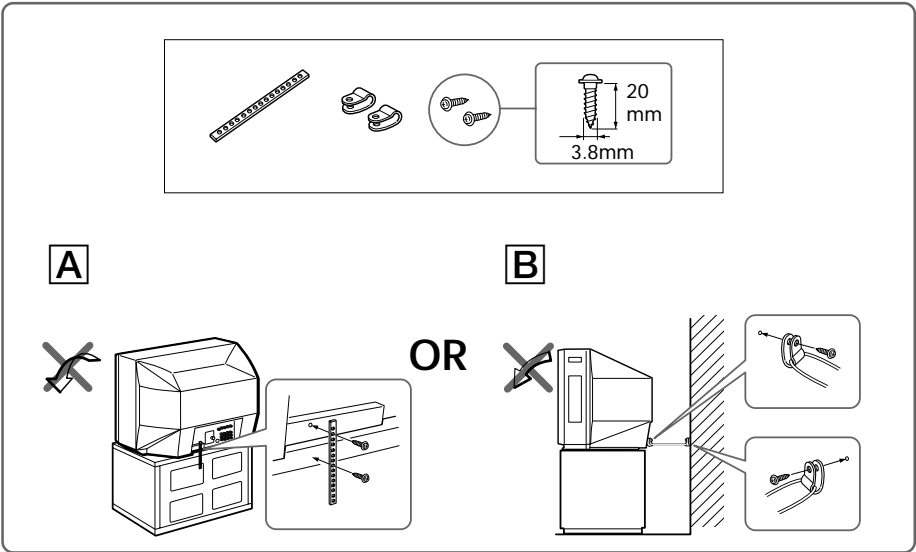

Note

- Use only the supplied screws. Use of other screws may damage the TV.

Watching the TV

This section explains various functions and operations used while watching the TV. Most operations can be done using the remote.

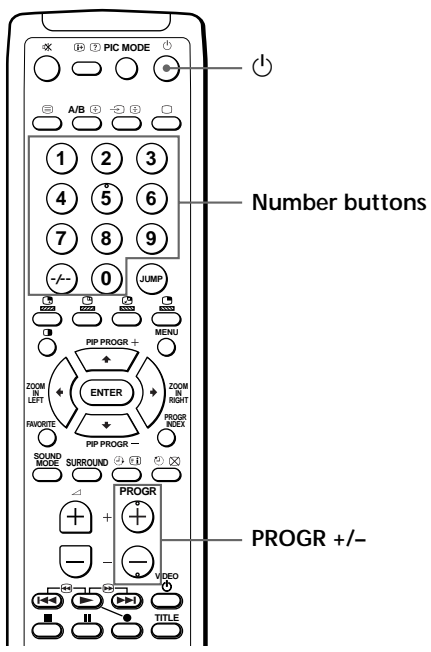
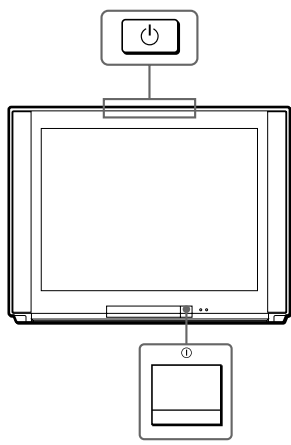

1 Press ① to turn on the TV.

When the TV is in standby mode (the indicator on the TV is lit red), press on the remote or on the TV.

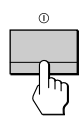

The PROGR +/-, , and indicators on the TV light up.

2 Press PROGR +/- or the number buttons to select the TV channel.

For double digit numbers, press , then the number (e.g., for 25, press , then 2 and 5).

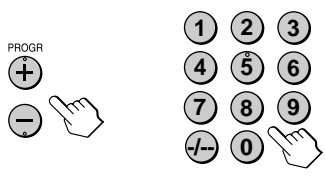

continued

Watching the TV (continued)

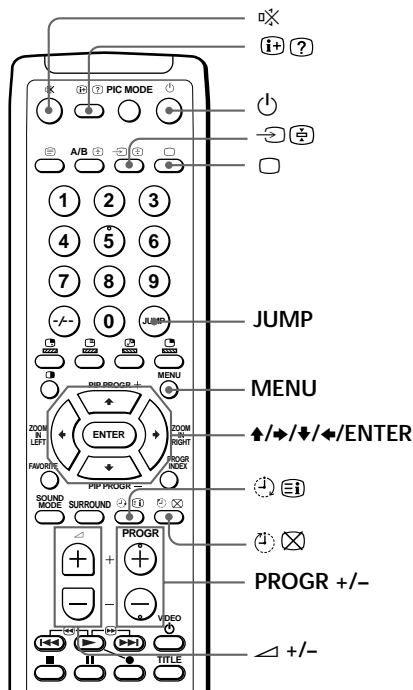
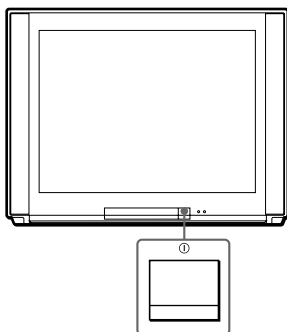

Additional tasks

To	Press
Turn off temporarily	⏻. The ⏻/∞/⏹ indicator on the TV lights up red.
Turn off completely	① on the TV.
Adjust the volume	⏮/+.
Mute the sound	⊘.
Watch the video input (VCR, camcorder, etc.)	⏮/⏭ (or ⏮ on the TV) to select "VIDEO 1," "VIDEO 2," "VIDEO 3," or "DVD." To return to the TV screen, press ⊠ (or ⏮ on the TV).
Jump back to the previous channel	JUMP.
Display the on-screen information*	ⓘ/?.

* The picture, sound, and either the program number or video mode are displayed. The on-screen display for the picture and sound information disappears after about 3 seconds.

Changing the menu language

You can change the menu language as well as the on-screen language. For details on how to use the menu, see “Introducing the menu system” on page 25.

1 Press MENU.

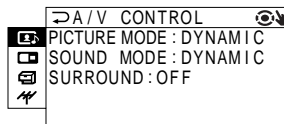

2 Press \uparrow or \downarrow to select , then press ENTER.

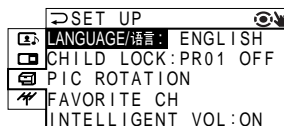
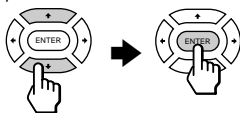

3 Make sure LANGUAGE/语言 is selected (highlighted), then press ENTER.



4 Press \uparrow or \downarrow to select 中文, then press ENTER.

The menu language changes to Chinese.

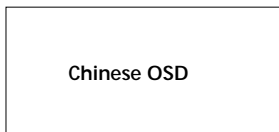
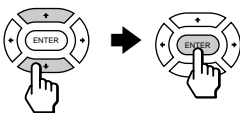

To return to the normal screen

Press MENU.

continued

Watching the TV (continued)

Selecting the picture mode

Press PIC MODE repeatedly until the desired picture mode is selected.

PIC MODE

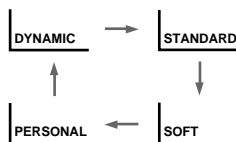

Select	To
DYNAMIC	receive high contrast pictures.
STANDARD	receive normal contrast pictures.
SOFT	receive mild contrast pictures.
PERSONAL	receive the last adjusted picture setting from the ADJUST option in the A/V CONTROL menu (see page 27).

Selecting the sound mode

Press SOUND MODE repeatedly until the desired sound mode is selected.

SOUND MODE

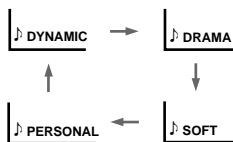

Select	To
DYNAMIC	listen to dynamic and clear sound that emphasizes both the low and high tones.
DRAMA	listen to sound that emphasizes voice and high tones.
SOFT	receive soft sound.
PERSONAL	receive the last adjusted sound setting from the ADJUST option in the A/V CONTROL menu (see page 27).

Tip

- You can also set the picture and sound modes using the menu (see “Changing the A/V CONTROL setting” on page 27).

Setting the Wake Up timer

- 1** Press  until the desired period of time appears.

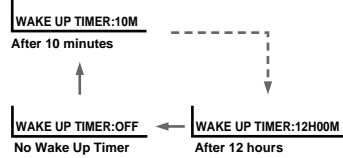

- 2** Select the TV channel or video mode you want to wake up to.

- 3** Press , or set the Sleep timer if you want the TV to turn off automatically.

The  indicator on the TV lights up orange.

To cancel the Wake Up timer

Press  until “WAKE UP TIMER: OFF” appears, or turn off the TV’s main power.

Notes

- The Wake Up timer starts immediately after the on-screen display disappears.
- If no buttons or controls are pressed for more than two hours after the TV is turned on using the Wake Up timer, the TV automatically goes into standby mode. To resume watching the TV, press any button or control on the TV or the remote.

Setting the Sleep timer

Press  until the desired period of time appears.

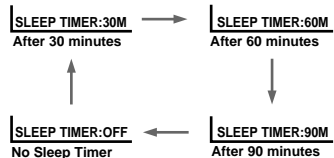

To cancel the Sleep timer

Press  until “SLEEP TIMER: OFF” appears, or turn the TV off.

Viewing your favorite channels

—FAVORITE CHANNEL

You can display seven “FAVORITE” channels for quick and easy selection.

The last seven channels selected with the number buttons are displayed in AUTO mode. You can set up your own “FAVORITE” channels in MANUAL mode (see “Changing the favorite channel setting” on page 33).

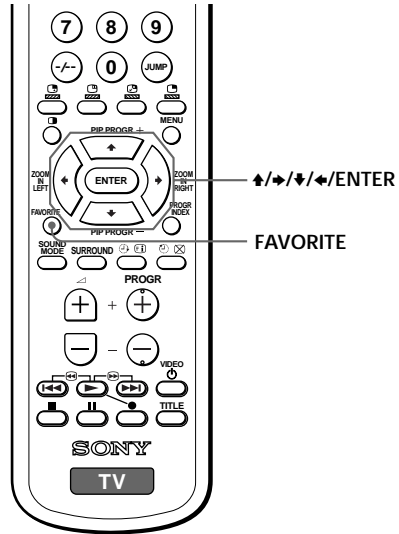

Selecting a favorite channel

- 1 Press FAVORITE.

The last seven channels selected with the number buttons appear.

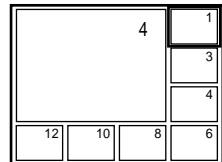

- 2 Press either \uparrow , \rightarrow , \downarrow , or \leftarrow to select the desired channel, then press ENTER.

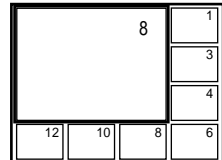
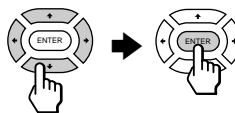

- 3 Press ENTER again.



Note

- When you use your TV for the first time, seven factory set, random channels appear.

Watching two programs at the same time

—PIP, TWIN

With the Picture-in-Picture (PIP) or TWIN pictures features, you can display a different TV program or video within or beside the main picture.

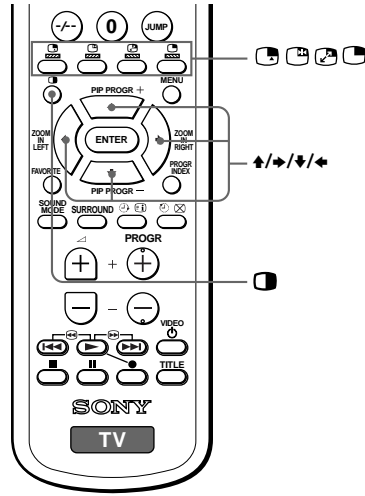

Displaying the PIP screen

Press .

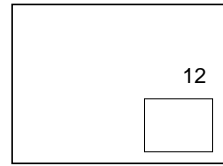

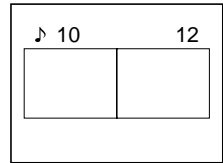

Displaying TWIN pictures

Press .



To return to the normal screen

Press  (when in the PIP screen) or  (when in the TWIN picture screen).







Tips

- You can also display the PIP screen or TWIN pictures using the menu (see “Changing the MULTI PICTURE setting” on page 29).
- You can change the position of the PIP screen (see “Changing the MULTI PICTURE setting” on page 29).

continued



Watching two programs at the same time—PIP, TWIN (continued)

Additional PIP/TWIN pictures tasks

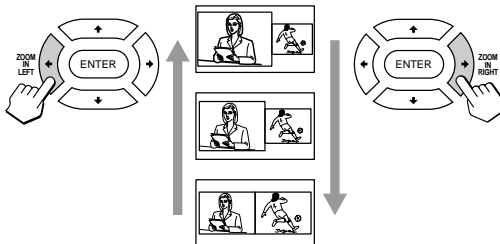
To	Press
change a TV program in the PIP screen or in the right TWIN picture	▲ or ▼. For a video input, press  .
swap pictures between the main and PIP screens	 
freeze the PIP screen	 To unfreeze the screen, press the button again.
swap the right and left pictures of the TWIN pictures	 
change the screen size of the TWIN pictures	ZOOM IN LEFT ◀ to increase the left screen size. ZOOM IN RIGHT ▶ to increase the right screen size.



Notes

- The  button does not function in the TWIN pictures mode.
- When you display a video input on the PIP screen at a faster/slower speed, the picture may be disrupted depending on the VCR type.
- If you display different color systems on the main screen and the PIP screen, the size of the PIP screen may be different and the PIP picture may be disrupted. This does not indicate a malfunction of the TV.
- In the TWIN picture screen, you can only operate and hear the sound of the main left screen (◁ appears on the screen).
- When the  button is pressed, the TV screen flickers or goes blank for about one second before the TWIN pictures appear. This does not indicate a malfunction of the TV.

Displaying multiple programs

—PROGRAM INDEX

The PROGRAM INDEX feature displays all of the preset TV programs and the video inputs on twelve or seven sub screens for direct selection.

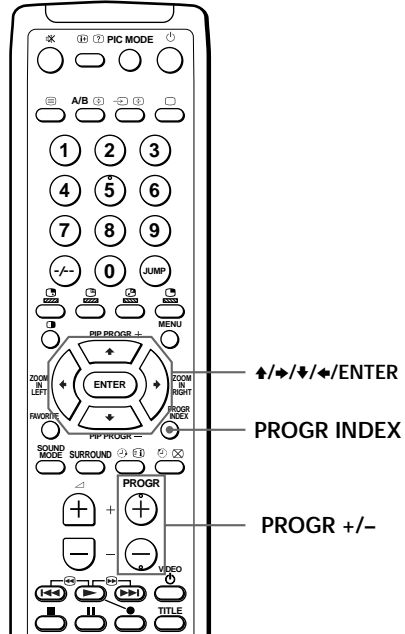

Press PROGR INDEX.

The first twelve preset programs appear one by one, clockwise from the upper left corner.

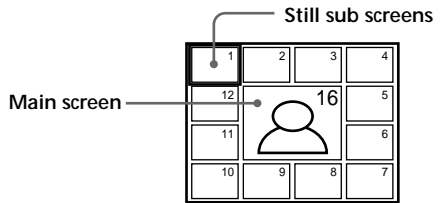

When the number of the preset TV programs is less than seven, the first seven preset programs appear one by one, clockwise from the upper right corner.

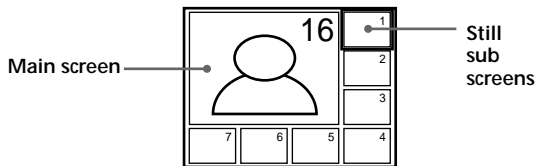

Tip

- When you press the PROGR INDEX button in the TWIN pictures mode, the left picture appears as the main screen of the PROGRAM INDEX mode.

continued

Displaying multiple programs—PROGRAM INDEX (continued)

To view the next or the previous twelve preset programs

This works only when the number of the preset TV programs is more than twelve.

Press **PROGR +/-** on the remote or the TV.

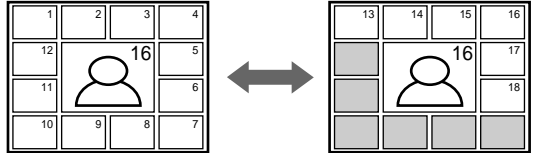

To select the desired program directly from the sub screens

1 Press either **↑**, **→**, **↓**, or **←** to move the frame to the screen of the program you want to watch.

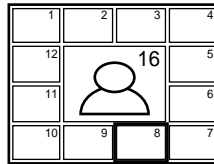
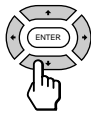

2 Press **ENTER**.

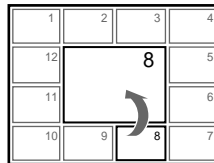

3 Press **ENTER** again.

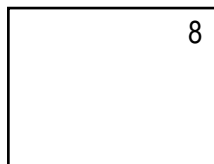

Tips

- You can also move the frame by pressing the **+/-** buttons on the TV. Press **+** to move the frame clockwise; press **-** to move the frame counterclockwise.
- Pressing the number buttons directly displays the program.

To return to the normal screen

Press **PROGR INDEX** again, or:

- 1 Select “**PROGR INDEX**” from the **MULTI PICTURE** menu.
- 2 Press **ENTER**.

Tip

- You can also display multiple programs using the menu (see “Changing the **MULTI PICTURE** setting” on page 29).

Note

- When displaying multiple programs, only the sound of the main screen is heard.

Listening with surround sound

The surround feature enables you to enjoy the sound effects of a concert hall or movie theater.

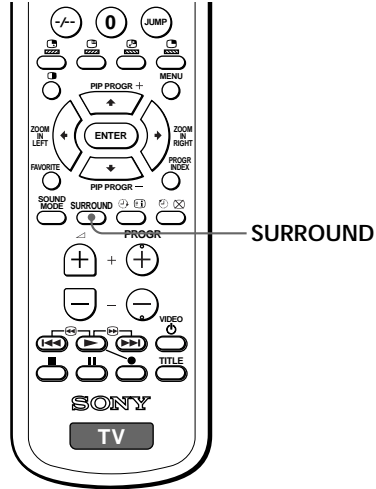

Press SURROUND repeatedly until you receive the desired surround sound.

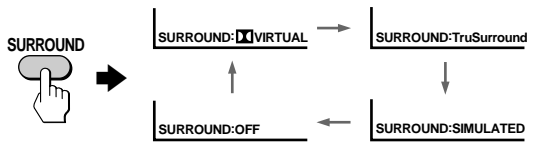

Select	To
<input checked="" type="checkbox"/> VIRTUAL	listen to Dolby* Surround encoded sound.
TruSurround	listen to the surround sound that spreads out to the rear of a room.
SIMULATED	listen to monaural sound with a stereo-like effect.
OFF	turn off the surround sound.

- The Virtual Dolby Surround of this model consists of Dolby Pro Logic and TruSurround.
- SIMULATED uses SRS (MONO).

* Manufactured under license from Dolby Laboratories Licensing Corporation. DOLBY, the double-D symbol  and "PRO LOGIC" are trademarks of Dolby Laboratories Licensing Corporation.



"**TruSurround**" is a trademark of SRS Labs, Inc. SRS and the SRS symbol are registered trademarks of SRS Labs, Inc. in the United States and selected foreign countries. SRS and TruSurround are incorporated under license from SRS Labs, Inc. and are protected under United States Patent Nos. 4,748,669 and 4,841,572 with numerous additional issued and pending foreign patents."

Selecting a stereo or bilingual program

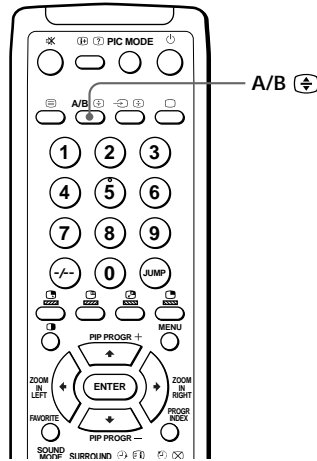
You can enjoy stereo sound or bilingual programs of NICAM and A2 (German) stereo systems.



Press A/B  repeatedly until you receive the sound mode you want.

The on-screen display changes to show the selected sound mode and the  /  /  indicator on the TV lights up red.

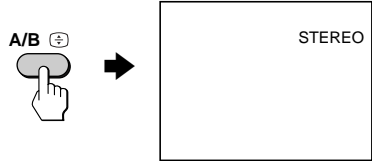

When receiving a NICAM program

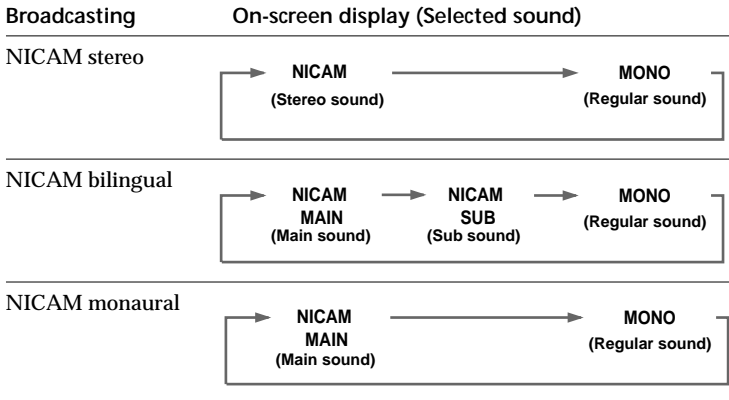

continued

Selecting a stereo or bilingual program (continued)

When receiving an A2 (German) program

Broadcasting	On-screen display (Selected sound)
A2 (German) stereo	
A2 (German) bilingual	

Receiving area for NICAM and A2 (German) programs

System	Receiving area
NICAM	Hong Kong, Singapore, New Zealand, Malaysia, Thailand, etc.
A2 (German)	Australia, Malaysia, Thailand, etc.

Notes

- If the signal is very weak, the sound becomes monaural automatically.
- If the stereo sound is noisy when receiving a NICAM program, select “MONO.” The sound becomes monaural, but the noise is reduced.

If the sound is distorted or noisy when receiving a monaural program through the ㊦ (antenna) terminal

Press A/B (⊕) repeatedly until “MONO” appears on the screen.

To cancel the monaural sound setting, press A/B (⊕) again until “AUTO” appears on the screen.



Notes

- The “MONO” or “AUTO” setting is memorized for each program position.
- You cannot receive a stereo broadcast signal when the TV is in the “MONO” setting. Normally, set the TV to “AUTO.”

Operating optional components

You can use the supplied remote to operate Sony video equipment such as Beta, 8mm, VHS, MDP, CD, or DVD.

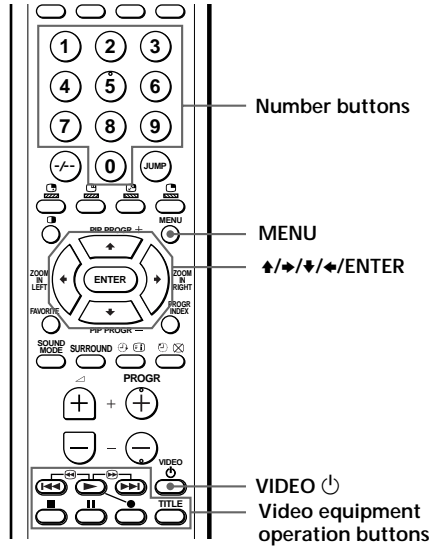

Setting up the remote to work with other connected equipment

While holding down VIDEO , press the following number combinations to enter the equipment's code number (see the chart below).

For example, to operate a Sony 8 mm VCR:

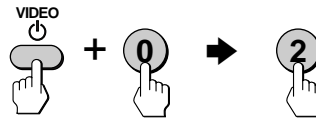

Code numbers for Sony video equipment

To control	Hold down VIDEO  and press
DVD	00
VTR1 (Beta)	01
VTR2 (8mm)	02
VTR3 (VHS)	03
MDP	04
CD	06
MD	07

Notes

- If your video equipment is furnished with a COMMAND MODE selector, set this selector to the same position as the setting code.
- If the equipment does not have a certain function, the corresponding button on the remote will not operate.
- When you remove the batteries, the code number may revert to the factory setting.

continued

Operating optional components (continued)

Operating a VCR using the remote

To	Press
turn on/off	VIDEO
record	while pressing .
play	
stop	
fast forward ()	
rewind the tape ()	
pause	 Press again to resume normal playback.
search the picture forward () or backward ()	or during playback. Release to resume normal playback.

Operating a DVD player using the remote

To	Press
turn on/off	VIDEO
play	
stop	
pause	 Press again to resume normal playback.
step through different tracks of an audio disc	to step forward or to step backward.
display the Title menu	TITLE
display the menu	MENU while holding down .
select the menu item	/// while holding down .

Operating an MDP using the remote

To	Press
turn on/off	VIDEO
play	
stop	
pause	 Press again to resume normal playback.
step through different tracks of a disc	to step forward or to step backward.





Operating a CD/MD using the remote

To	Press
turn on/off	VIDEO
play	
stop	
pause	 Press again to resume normal playback.
go to the next/previous tracks	or
go forward () / backward () quickly in a track	or while holding down .

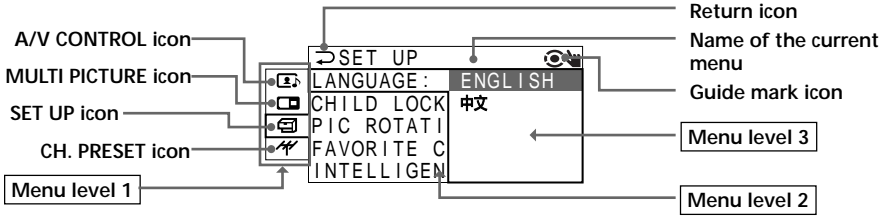
Introducing the menu system

The MENU button lets you open a menu and change the settings of your TV. The following is an overview of the menu system.



Level 1	Level 2	Level 3/Function
A/V CONTROL 	PICTURE MODE	Select the picture mode: DYNAMIC → STANDARD → SOFT → PERSONAL → ADJUST
	ADJUST	Adjust the PERSONAL option: PICTURE → COLOR → BRIGHT → HUE → SHARP
	SOUND MODE	Select the sound mode: DYNAMIC → DRAMA → SOFT → PERSONAL → ADJUST
	ADJUST	Adjust the PERSONAL option: BASS → TREBLE → BALANCE → BBE*
MULTI PICTURE 	SURROUND	Select the surround mode: <input type="checkbox"/> VIRTUAL → TruSurround → SIMULATED → OFF
	PIP POSITION	Change the position of the sub screen.
	PIP	Activate or deactivate the PIP feature.
	SWAP	Swap the pictures between the main and sub screens.
	TWIN	Display a TV program or video beside the main screen.
SET UP 	PROGRAM INDEX	Display all the preset TV programs at the same time.
	LANGUAGE/ 语言	Change the menu language: ENGLISH ↔ 中文 (CHINESE)
	CHILD LOCK	Lock out specific channels.
	PIC ROTATION	Rotate the picture.
	FAVORITE CH	Set favorite channels.
CH. PRESET 	INTELLIGENT VOL	Adjust the volume automatically.
	AUTO PROGRAM	Preset channels automatically.
	MANUAL PROGRAM	Preset channels manually.
	SKIP	Skip unwanted or unused program numbers.
	TV SYS	Select the TV system: B/G → I → D/K → M
	COL SYS	Select the color system: AUTO → PAL → SECAM → NTSC3.58 → NTSC4.43

* The BBE is manufactured by Sony Corporation under license from BBE Sound, Inc. It is covered by U.S. Patent No. 4,638,258 and No. 4,482,866. The word "BBE" and the BBE symbol are the trademarks of BBE Sound, Inc.

continued

Introducing the menu system (continued)

How to use the menu

Press MENU to display the menu.

Press \uparrow or \downarrow (or \leftarrow / \rightarrow) to select the desired item.

Press ENTER to confirm the selection and/or go to the next level.

Other menu operations

To	Press
Adjust the setting value	\uparrow / \leftarrow or \downarrow / \rightarrow
Move to the next/previous menu level	\rightarrow or \leftarrow
Cancel the menu	MENU

Tips

- If you want to exit from Menu level 2 to Menu level 1, press \uparrow or \downarrow until the return icon (↵) is highlighted, then press ENTER.
- The MENU, ENTER, and +/- buttons on the TV can also be used for the operations above.

Note

- If more than 60 seconds elapse between entries, the menu screen automatically disappears.

Changing the A/V CONTROL setting

The A/V CONTROL menu allows you to adjust the picture and sound settings.

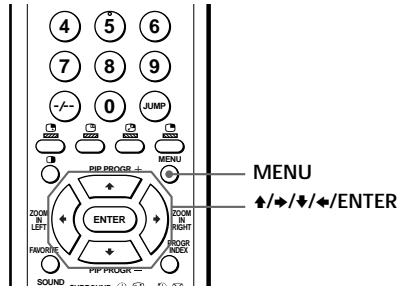

1 Press MENU.



2 Press ↑ or ↓ to select , then press ENTER.

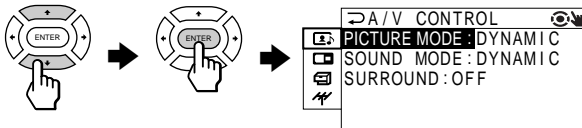

3 Press ↑ or ↓ to select either PICTURE MODE, SOUND MODE, or SURROUND, then press ENTER.

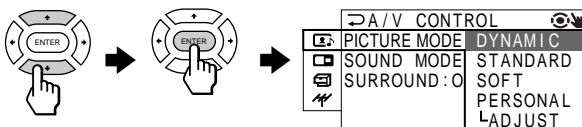

4 Press ↑ or ↓ to select the desired option, then press ENTER.

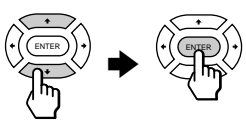

For	Select
PICTURE MODE	either DYNAMIC, STANDARD, SOFT, PERSONAL*, or ADJUST.
SOUND MODE	either DYNAMIC, DRAMA, SOFT, PERSONAL*, or ADJUST.
SURROUND	either  VIRTUAL, TruSurround, SIMULATED, or OFF.

* When the PERSONAL mode is selected, the last adjusted picture/sound settings from the ADJUST option are received (see next page).

- Tip**
- For details on the options under the PICTURE/SOUND MODE and SURROUND modes, see pages 12 and 20 respectively.

To return to the normal screen
Press MENU.

Changing the A/V CONTROL setting (continued)

Adjusting the ADJUST options under PICTURE MODE

- 1** Press \uparrow or \downarrow to select the desired item (e.g., COLOR), then press ENTER.



- 2** Adjust the value according to the following table, then press ENTER.

For	Press \downarrow/\leftarrow to	Press \uparrow/\rightarrow to
PICTURE	decrease picture contrast	increase picture contrast
COLOR	decrease color intensity	increase color intensity
BRIGHT	darken the picture	brighten the picture
HUE*	increase red picture tones	increase green picture tones
SHARP	soften the picture	sharpen the picture

* You can adjust HUE for the NTSC color system only.

- 3** Repeat the above steps to adjust other items.
The adjusted settings will be received when you select PERSONAL.

Adjusting the ADJUST options under SOUND MODE

- 1** Press \uparrow or \downarrow to select the desired item (e.g., BALANCE), then press ENTER.

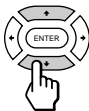

- 2** Adjust the value according to the following table, then press ENTER.

For	Press
BASS	\downarrow/\leftarrow to decrease the bass, \uparrow/\rightarrow to increase the bass
TREBLE	\downarrow/\leftarrow to decrease the treble, \uparrow/\rightarrow to increase the treble
BALANCE	\downarrow/\leftarrow to increase the left speaker's volume, \uparrow/\rightarrow to increase the right speaker's volume
BBE	\uparrow/\downarrow to select HIGH, LOW, or OFF. BBE can produce clear sound, emphasizing both low and high tones.

- 3** Repeat the above steps to adjust other items.
The adjusted settings will be received when you select PERSONAL.

Tip

- For details on the menu system and how to use the menu, refer to "Introducing the menu system" on page 25.

Changing the MULTI PICTURE setting

The MULTI PICTURE menu allows you to use the Picture-in-Picture (PIP), TWIN pictures, or PROGRAM INDEX features.

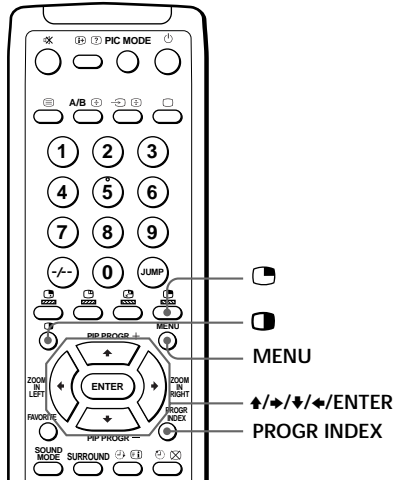

1 Press MENU.

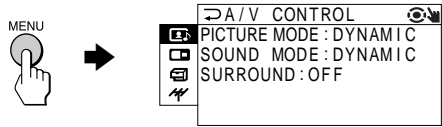

2 Press \uparrow or \downarrow to select \square , then press ENTER.

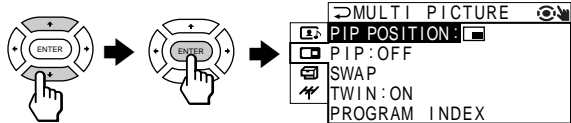



continued

Changing the MULTI PICTURE setting (continued)

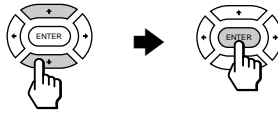
- 3** Press \uparrow or \downarrow to select the desired option (see the table below), then press ENTER.



Select	To
PIP POSITION	<p>change the position of the PIP screen. Press \uparrow or \downarrow to select the desired position, then press ENTER.</p>
PIP	<p>display the PIP screen within the main picture. Press \uparrow or \downarrow to select "ON," then press ENTER. To cancel, press  or select "OFF," then press ENTER.</p>
SWAP	<p>swap the main and PIP screens, or right and left pictures of the TWIN pictures.</p>
TWIN	<p>display a different TV program or video beside the main picture. Press \uparrow or \downarrow to select "ON," then press ENTER. To cancel, press  or select "OFF," then press ENTER.</p>
PROGRAM INDEX	<p>view multiple programs on the sub-screens. To cancel, press PROGRAM INDEX.</p>

To return to the normal screen

Press MENU.

Tip

- For details on the menu system and how to use the menu, see "Introducing the menu system" on page 25.

Changing the SET UP setting

The SET UP menu allows you to: change the menu language (see page 11), block channels, adjust the picture position, program your favorite channels, and adjust the volume automatically.

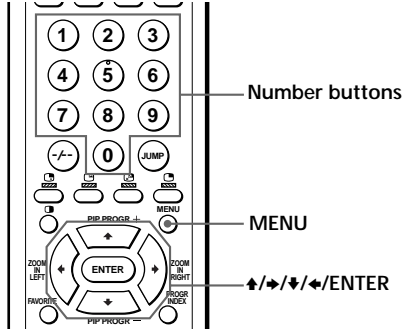

1 Press MENU.

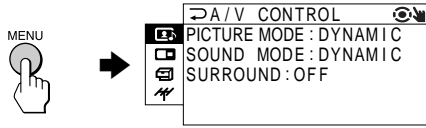

2 Press \uparrow or \downarrow to select , then press ENTER.

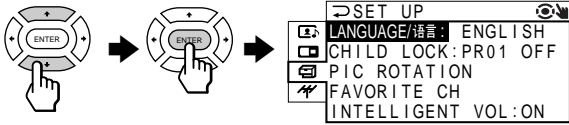

3 Press \uparrow or \downarrow to select the desired option, then press ENTER.

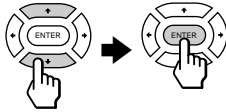

Select	To
LANGUAGE/ 语言	change the menu language (see page 11).
CHILD LOCK	block channels (see page 32).
PIC ROTATION	adjust the picture position when it is not aligned with the TV screen. Press \uparrow or \rightarrow to adjust the position clockwise, then press ENTER. Press \downarrow or \leftarrow to adjust the position counterclockwise, then press ENTER.
FAVORITE CH	select your favorite channels (see page 33).
INTELLIGENT VOL	adjust the volume of each TV program automatically. Press \uparrow or \downarrow to select "ON," then press ENTER. To cancel, select "OFF," then press ENTER.



To return to the normal screen

Press MENU.

continued

Changing the SET UP setting (continued)

Blocking the channels (CHILD LOCK)

- 1** After selecting CHILD LOCK, press either \uparrow or \downarrow , or the number buttons (or PROGR +/-) to select the desired channel, then press ENTER.

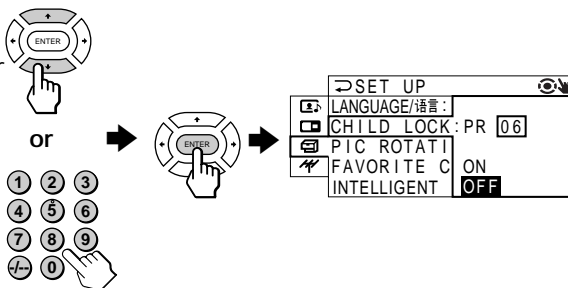

- 2** Press \uparrow or \downarrow to select ON, then press ENTER. To unlock the channel, select OFF.

The lock symbol (🔒) appears on the screen when ON is selected.

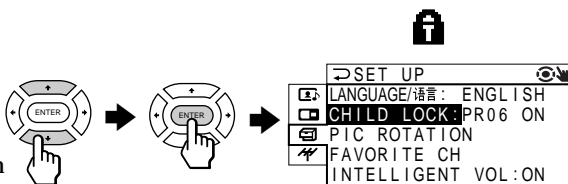

If a locked channel is selected, the lock symbol appears on the screen.



- 3** Repeat steps 1 and 2 to lock other channels.

To return to the normal screen

Press MENU.

Changing the favorite channel setting

- 1** After selecting FAVORITE CH, make sure MODE is selected, then press ENTER.



FAVORITE CH	
MODE :	AUTO
1 . PR01	MANUAL
2 . PR02	
3 . PR06	
4 . PR08	

- 2** Press \uparrow or \downarrow to select MANUAL, then press ENTER.



FAVORITE CH	
MODE	MANUAL
1 . PR01	5 . PR09
2 . PR02	6 . PR11
3 . PR06	7 . PR13
4 . PR08	

- 3** Press \uparrow or \downarrow to select the program you want to change, then press ENTER.

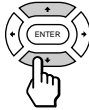

FAVORITE CH	
MODE	MANUAL
1 . PR01	5 . PR09
2 . PR02	6 . PR11
3 . PR06	7 . PR13
4 . PR08	

- 4** Press \uparrow or \downarrow to change the number, then press ENTER.



FAVORITE CH	
MODE	MANUAL
1 . PR01	5 . PR09
2 . PR02	6 . PR11
3 . PR05	7 . PR13
4 . PR08	

- 5** Repeat steps 3 and 4 to set other channels.

To return to the normal screen

Press MENU.

Note

- If you press the PROGR +/- buttons or number buttons in step 4 above, the TV will tune into the channel.

Changing the CH. PRESET setting

The CH. PRESET menu allows you to adjust the setup of your TV. For example, you can manually tune in a channel with a weak signal that fails to be tuned in by automatic presetting.

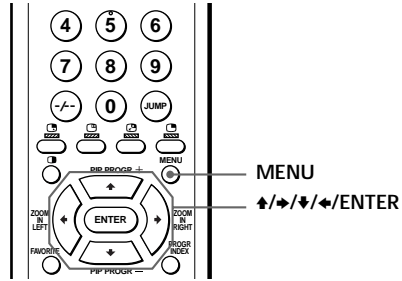

1 Press MENU.

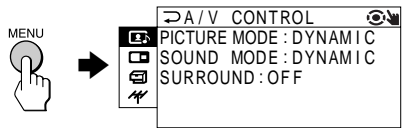

2 Press \uparrow or \downarrow to select \mathcal{A} , then press ENTER.

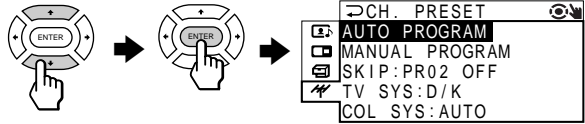

3 Press \uparrow or \downarrow to select the desired option, then press ENTER.

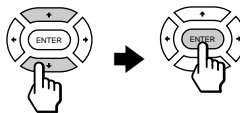

Select	To
AUTO PROGRAM	preset channels automatically.
MANUAL PROGRAM	preset channels manually. See “Presetting channels manually” on page 35.
SKIP	skip unwanted or unused channel. 1 Press either \uparrow or \downarrow , or the number buttons (or PROGR +/-) until the unused or unwanted channel number appears, then press ENTER. 2 Select “ON,” then press ENTER. 3 To disable other channels, repeat steps 1 and 2. To restore the skipped channel, select “OFF” in step 2.
TV SYS	select the TV system.
COL SYS	select the color system. Normally, set this to “AUTO.”

To return to the normal screen

Press MENU.

Tip

- For details on the menu system and how to use the menu, refer to “Introducing the menu system” on page 25.

Presetting channels manually

1 After selecting MANUAL PROGRAM, select the program number to which you want to preset a channel.

(1) Make sure "PR" is selected, then press ENTER.

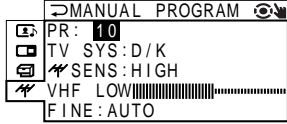

(2) Press **▲** or **▼** until the program number you want to preset (e.g., program number 10) appears on the menu, then press ENTER.

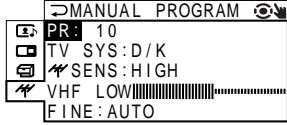
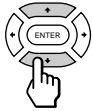

Tip

- You can also select the program number with the **PROGR +/-** or number buttons.

2 Select the desired channel.

(1) Press **▲** or **▼** to select either VHF LOW, VHF HIGH, or UHF, then press ENTER.

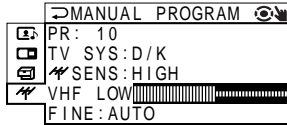
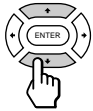

(2) Press **▲** or **▼** until the desired channel's broadcast appears on the TV screen, then press ENTER.

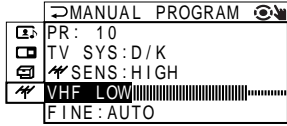
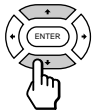

3 If the sound of the desired channel is abnormal, select the appropriate TV system.

(1) Press **▲** or **▼** to select TV SYS, then press ENTER.

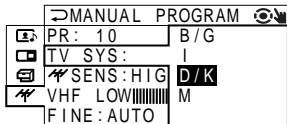
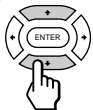

(2) Press **▲** or **▼** until the sound becomes normal, then press ENTER.

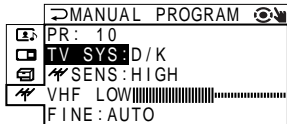
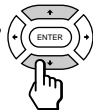

continued

Changing the CH. PRESET setting (continued)

4 If you are not satisfied with the picture and sound quality, you may be able to improve them by using the FINE tuning feature.

- (1) Press **▲** or **▼** to select FINE, then press ENTER.

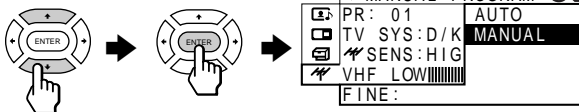

- (2) Press **▲** or **▼** to select MANUAL, then press ENTER.

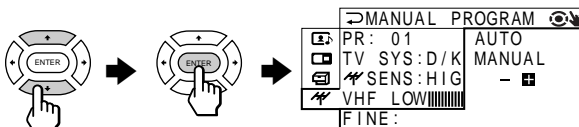

- (3) Press either **▲**, **▶**, **▼** or **◀** until the picture and sound quality are optimal, then press ENTER.

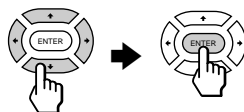

The + or - icon on the menu flashes while tuning.

5 If the TV signal is too strong and the picture is distorted, you can adjust the TV reception sensitivity.

- (1) Press **▲** or **▼** to select **SENS**, then press ENTER.

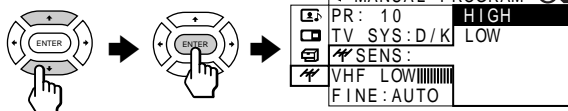

- (2) Press **▲** or **▼** to select LOW, then press ENTER.

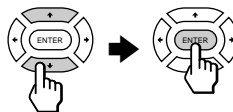

To return to the normal screen









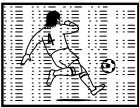

Press MENU.

Notes

- The TV system (TV SYS) and the TV reception sensitivity (SENS) settings are memorized for each program number.
- If you preset a locked channel, that channel will be unlocked.







Troubleshooting

If you have any problem while viewing your TV, please check the following troubleshooting guide. If the problem persists, contact your Sony dealer.

Symptom	Solutions	Possible cause
Snowy picture 	<ul style="list-style-type: none"> • Check the antenna cable and connection on the TV, VCR, and at the wall. (page 4) • Display the CH. PRESET menu and select "MANUAL PROGRAM" to preset the channel again. (page 35) 	<ul style="list-style-type: none"> • The connection is loose or the cable is damaged. • The channel presetting is inappropriate or incomplete.
Noisy sound 	<ul style="list-style-type: none"> • Check the antenna type (VHF/UHF). Contact a Sony dealer for advice. • Adjust the antenna direction. Contact a Sony dealer for advice. • Try using a booster. 	<ul style="list-style-type: none"> • The antenna type is inappropriate. • The antenna direction needs adjustment. • Signal transmission is low.
Distorted picture 	<ul style="list-style-type: none"> • Display the CH. PRESET menu and select "MANUAL PROGRAM." Then, select "SENS: LOW." (page 36) • Turn off or disconnect the booster if it is in use. 	<ul style="list-style-type: none"> • Broadcast signals are too strong.
Noisy sound 		
Good picture 	<ul style="list-style-type: none"> • If the sound of all the channels is noisy, display the CH. PRESET menu and select "AUTO PROGRAM" to preset the channels again. (page 34) • If the sound of some channels is noisy, select the channel, then display the CH. PRESET menu and select the appropriate TV system (TV SYS). (page 35) 	<ul style="list-style-type: none"> • The TV system setting is inappropriate.
Noisy sound 		
No picture 	<ul style="list-style-type: none"> • Check the power cord, antenna, and the VCR connections. • Press  (power). • Press  (main power) on the TV to turn off the TV for about five seconds, then turn it on again. 	<ul style="list-style-type: none"> • The power cord, antenna, or VCR is not connected. • The TV is not turned on.
No sound 		



continued

Troubleshooting (continued)

Symptom	Solutions	Possible cause
<p>Good picture</p> 	<ul style="list-style-type: none"> • Press \triangle + to increase the volume level. • Press \otimes to cancel the muting. • Press A/B (⊕) until better sound is heard. 	<ul style="list-style-type: none"> • The volume level is too low. • The sound is muted. • The broadcast signal has a transmission problem.
<p>No sound</p> 		
<p>Dotted lines or stripes</p> 	<ul style="list-style-type: none"> • Do not use a hair dryer or other equipment near the TV. • Adjust the antenna direction for minimum interference. Contact a Sony dealer for advice. 	<ul style="list-style-type: none"> • There is local interference from cars, neon signs, hair dryers, power generators, etc.
<p>Double images or "ghosts"</p> 	<ul style="list-style-type: none"> • Use a highly directional antenna. • Use the FINE tuning feature. (page 36) • Adjust the antenna direction. Contact a Sony dealer for advice. • Turn off or disconnect the booster if it is in use. 	<ul style="list-style-type: none"> • Broadcast signals are reflected by nearby mountains or buildings. • The antenna direction needs adjustment. • Use of a booster is inappropriate.
<p>No color</p> 	<ul style="list-style-type: none"> • Display the A/V CONTROL menu and select "ADJUST" in PICTURE MODE, then adjust the COLOR level. (page 28) • Display the CH. PRESET menu and check the color system (COL SYS) setting (usually set this to AUTO). (page 34) • Adjust the antenna direction. Contact a Sony dealer for advice. 	<ul style="list-style-type: none"> • The color level setting is too low. • The color system setting is inappropriate. • The antenna direction needs adjustment.
<p>Abnormal color patches</p> 	<ul style="list-style-type: none"> • Locate external speakers or other equipment away from the TV. Press ① (main power) on the TV to turn off the TV for about five minutes, then turn it on again. 	<ul style="list-style-type: none"> • There is magnetic disturbance from external speakers or other equipment.
<p>TV cannot receive stereo broadcast signal.</p>	<ul style="list-style-type: none"> • Press A/B (⊕) until "AUTO" appears on the screen. 	<ul style="list-style-type: none"> • The stereo reception setting is inappropriate.

Symptom	Solutions	Possible cause
Stereo broadcast sound switches on and off or is distorted. OR The sound switches between stereo and monaural frequently.	<ul style="list-style-type: none"> • Check the antenna cable and connection on the TV, VCR, and on the wall. 	<ul style="list-style-type: none"> • The connection is loose or the cable is damaged.
	<ul style="list-style-type: none"> • Adjust the antenna direction. Contact a Sony dealer for advice. • Press A/B (⊕) until better sound is heard. (page 21) 	<ul style="list-style-type: none"> • The antenna direction needs adjustment. • The broadcast signal has a transmission problem.
Picture slant 	<ul style="list-style-type: none"> • Display the SET UP menu and adjust "PIC ROTATION" so that the picture is aligned to the TV screen. (page 31) 	<ul style="list-style-type: none"> • Terrestrial magnetism is affecting your TV set.
Lines moving across the TV screen.	<ul style="list-style-type: none"> • Use the FINE tuning feature. (page 36) 	<ul style="list-style-type: none"> • There is interference from external sources (e.g., heavy machinery or a nearby broadcast station, etc.).
TV cabinet creaks.	—	<ul style="list-style-type: none"> • Changes in room temperature sometimes make the TV cabinet expand or contract, causing a noise. This does not indicate a malfunction.
A small "boom" sound is heard when the TV is turned on.	—	<ul style="list-style-type: none"> • The TV's demagnetizing function is working. This does not indicate a malfunction.

Self-diagnosis function

Your TV is equipped with a self-diagnosis function. If there is a problem with your TV, the  (standby) indicator flashes red. The number of times the  indicator flashes indicates the possible causes.

Front of TV

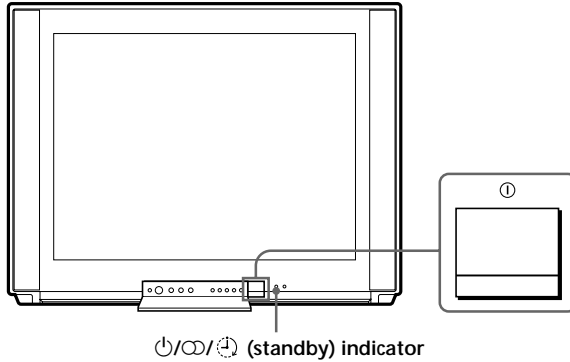

-
- 1** Check that the red flashes of the  indicator are about 3 seconds per interval.

 - 2** Count the number of times the  indicator flashes.

 - 3** Press  (main power) to turn off your TV.

 - 4** Inform your nearest Sony service center about the number of times the  indicator flashed.
Be sure to note the model name and serial number located on the rear of your TV.
-

Identifying parts and controls

Refer to the pages indicated in parentheses () for details.

Front panel

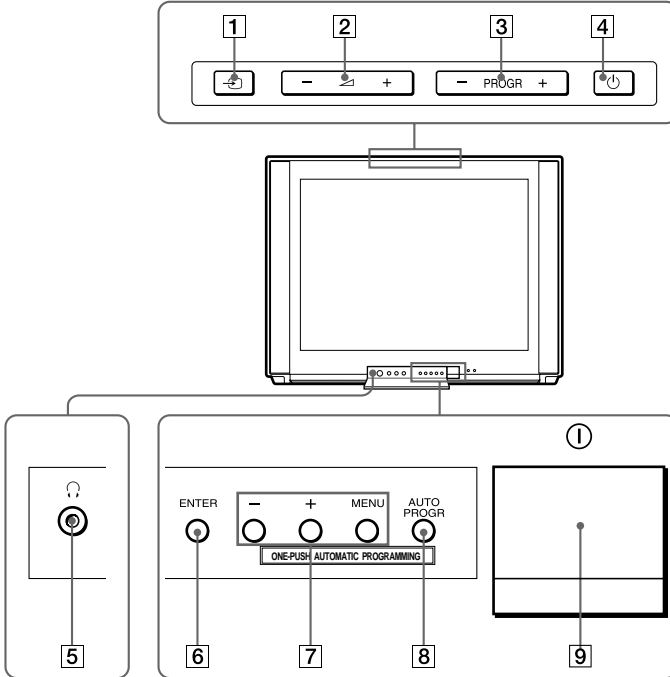

- 1 ⇄ (TV/video) button (10)
- 2 ∟ +/- (volume) buttons (10)
- 3 PROGR +/- (program) buttons (9)
- 4 ⏻ (power) button (9)
- 5 🎧 (headphones) jack
- 6 ENTER button (26)
- 7 MENU +/- buttons (26)
- 8 AUTO PROGR (program) button (5)
- 9 ① (main power) button (9)

continued

Identifying parts and controls (continued)

Remote control

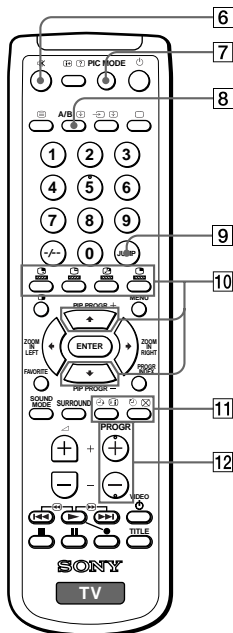
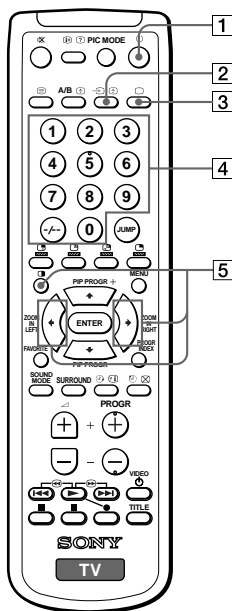

- 1 (power) button (9)
- 2 (video) button (10)
- 3 (TV) button (10)
- 4 Number buttons (9)
- 5 TWIN pictures operation buttons (15 – 16)

- (TWIN)
- ZOOM IN LEFT
- ZOOM IN RIGHT

The names/symbols of buttons on the remote are indicated in different colors to represent the available functions.

Label color	Button function
White	For general TV and PROGRAM INDEX operations
Yellow	For PIP operations

- 6 (muting) button (10)
- 7 PIC MODE button (12)
- 8 A/B button (21)
- 9 JUMP button (10)
- 10 PIP operation buttons (15 – 16)
 - (TV/video)
 - (freeze)
 - (swap)
 - (PIP)
 - for changing PIP PROGR
- 11 Timer setting buttons (13)
 - (wake up timer)
 - (sleep timer)
- 12 PROGR +/- (program) buttons (9)

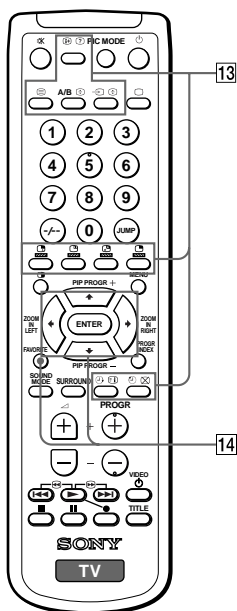

13 Teletext operation buttons
Not available on this model.

- (text)
- (enlarge)
- (reveal)
- (hold)
- Red
- Green
- Yellow
- Blue
- (index)
- (text clear)

14 FAVORITE button (14)

- /ENTER

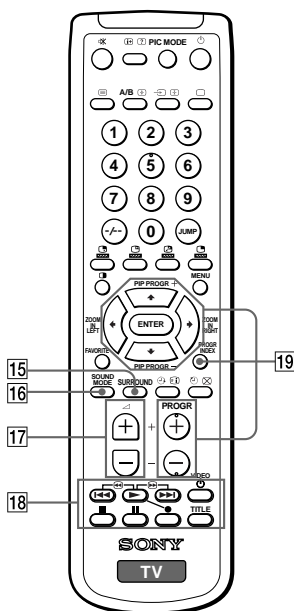

15 SURROUND button (20)

16 SOUND MODE button (12)

17 \triangleleft (volume) +/- buttons (10)

18 DVD, VCR, MDP, CD, MD operation buttons (24)

(fastforward/search forward)

(play)

(rewind/search backward)

(record)

(stop)

(pause)

VIDEO (power)

TITLE

19 PROGRAM INDEX operation buttons (17 - 19)

PROGR INDEX

/ENTER

PROGR +/-

Specifications

	KV-EF34M90	Note
Power requirements	110-240 V AC, 50/60 Hz	
Power consumption (W)	Indicated on the rear of the TV	
Television system	B/G, I, D/K, M	
Color system	PAL, PAL 60, SECAM, NTSC4.43, NTSC3.58	
Stereo system	NICAM Stereo B/G, I; A2 Stereo (German) B/G	
Channel coverage		
B/G	VHF : E2 to E12 / UHF : E21 to E69 / CATV : S01 to S03, S1 to S41	
I	UHF : B21 to B68 / CATV : S01 to S03, S1 to S41	
D/K	VHF : C1 to C12, R1 to R12 / UHF : C13 to C57, R21 to R60 / CATV : S01 to S03, S1 to S41, Z1 to Z39	
M	VHF : A2 to A13 / UHF : A14 to A79 / CATV : A-8 to A-2, A to W+4, W+6 to W+84	
⌚(Antenna)	75-ohm external terminal	
Audio output (Speaker)	15W + 15W*	
Number of terminal		
📺 (Video)	Input: 4 Output: 1	phono jacks; 1 Vp-p, 75 ohms
🎵 (Audio)	Input: 4 Output: 1	phono jacks; 500 mVrms
📺 (S Video)	Input: 2	Y: 1 Vp-p, 75 ohms, unbalanced, sync negative C: 0.286 Vp-p, 75 ohms
📺 (Component Video)	Input: 1	phono jacks Y: 1.0 Vp-p, 75 ohms, sync negative Cr: 0.7 Vp-p, 75 ohms Cb: 0.7 Vp-p, 75 ohms Audio: 500 mVrms,
🎧 (Headphones)	Output: 1	Stereo minijack
Picture tube	34 in.	
Tube size (cm)	86	Measured diagonally
Screen size (cm)	80	Measured diagonally
Dimensions (w/h/d, mm)	859 × 661 × 574	
Mass (kg)	83	

* 10% distortion

Design and specifications are subject to change without notice.

Sony **on** line

<http://www.world.sony.com/>

Printed on recycled paper

Sony Corporation Tokyo, Japan